



# JONNESWAY®

Herramientas Profesionales Manuales y Neumáticas



**10** años de profesionales  
para profesionales

**2018**



# JONNESWAY®

Herramientas Profesionales Manuales y Neumáticas



Este catálogo reemplaza a todas las ediciones anteriores.  
Estos precios están sujetos a IVA o tasa legal en vigor.

Jonnesway está desarrollando constantemente sus productos, por tanto, sus modelos, composiciones, características técnicas, físicas, diseño y precios se pueden cambiar, sustituir y eliminar de este catálogo sin previo aviso y sin obligación de realizar ningún cambio en las herramientas y/o el equipo vendido previamente. Las capacidades indicadas para los productos son los resultados de las pruebas realizadas en los laboratorios Jonnesway. Por tanto no son contractuales.



[www.jonneswaytools.com](http://www.jonneswaytools.com)



[facebook.com/jonneswaytools](https://facebook.com/jonneswaytools)

Versión 3.1 Catálogo de España  
Entrará en vigor en enero de 2018

<b>Carros y Composiciones de Herramientas</b>	Carros y composiciones de herramientas	6-16
	Bolsas vacías y accesorios para carros	17-20
<b>Otros Equipos</b>	Otros equipos	22-26
<b>Herramientas Manuales</b>	Tableros para herramienta	28-42
	Herramienta manual	43-82
	Alicates	83-89
	Destornilladores	90-101
	Martillos	102
	Varios	103-106
	Herramienta aislada 1 000V	107-110
	<b>Herramienta Especial Mecánica</b>	Mecánica
	Motocicletas	137-139
	Chapista	140-143
	Pesados	144
	Accesorios	145
<b>Herramienta Neumática</b>	Herramienta neumática	148-162
	Accesorios para redes de aire comprimido	163-164
<b>Comercialización</b>	Comercialización	166-167





# JONNESWAY®

Herramientas Profesionales

• Manuales • Neumáticas •

específicas para automóviles, motocicletas y vehículos pesados





**JONNESWAY®**

## Carros y Composiciones de Herramientas

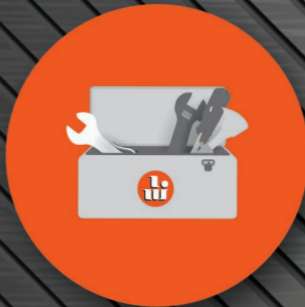

Carros y composiciones de herramientas

Bolsas vacías y accesorios para carros



**MECPOWER EVA17**

1 050.00€

Carro de composición de herramientas con 6 cajones con guías telescópicas

Superficie de trabajo resistente a los golpes

Dimensiones: 670x460x960mm

Composición:

- S04H4144KV Juego de llaves con trinquete de 1/2" y 1/4" con 44 piezas
- S04H2132KV Juego de llaves de vela, extensores y bits con 32 piezas
- W26116KV Juego de llaves mixtas con 16 piezas
- S03A4122KV Juego de llaves de impacto de 1/2" con 22 piezas
- M63113KV Juego de punzones, saca trozos y cinceles con 13 piezas
- D71PP08KV Juego de destornilladores/ phillips con 8 piezas
- W25110KV Juego de llaves inglesas con 10 piezas
- P011804KV Juego de alicates con 4 piezas
- S29H4141KV Juego de llaves de frenos y bits con 41 piezas
- H10MB08KV Juego de llaves hexagonales con mango con 8 piezas
- H10MT08KV Juego de llaves torx con mango con 8 piezas
- M09103KV Juego de martillos con 3 piezas
- P32M105KV Juego de alicates de frenos con 5 piezas
- MHS08KV Juego de sierra, regla, x-ato y cinta métrica

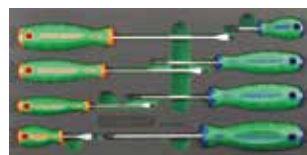
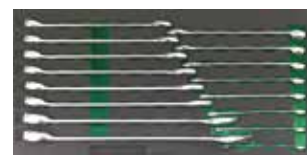

**MEC SOLUTION**

870.00€

Carro de herramientas con composición flexible, adaptado a sus necesidades con 6 cajones (C-6DWB1) - también lleva 3 tableros EVA, 1 de tipo A y 2 de tipo B.

Dimensiones: 670x460x960mm

**Nueva  
composición  
flexible**



**Tableros Tipo A**



S04H42165SV



S04H3194SV

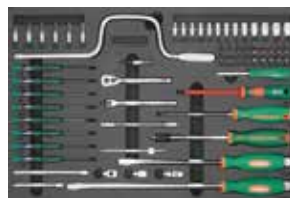

S04H2184SV

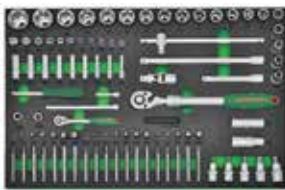

S04H4295SV



S04H46121SV

**Tableros Tipo B**

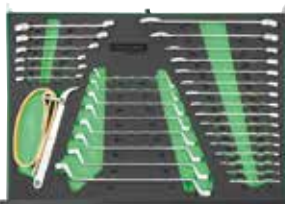

W2623431SV

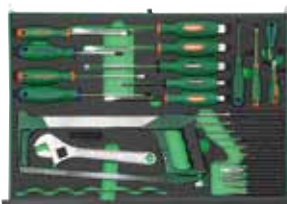

D737128SV



H10121SV



D737134SV



P82736SV

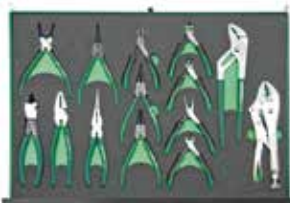

P82714SV



W23559SV



D71157SV



W26134SV





**BlackPower**

920.00€

Carro de herramientas para mecánico con 7 cajones (C-7DB2)  
Con el conjunto de herramientas a continuación



**MECPower**

1 055.00€

Carro de herramientas para mecánico con 7 cajones (C-6DW1)  
Con el conjunto de herramientas a continuación  
Incluye asa C-A3



Composición:

- Juego 4 alicates clips
- Juego 3 alicates (universal/ puntas/ corte)
- Juego 2 martillos y cinceles
- Juego 8 llaves destornilladores/ philips
- Juego 9 llaves macho hexagonal
- Juego 8 llaves torx dobles con mango
- Juego sierra, botadores y llave inglesa
- Juego alicate de presión y alicate ajustable

- Juego llaves impacto de 1/2"
- Juego llaves vaso y carraca 1/4"
- Juego llaves vaso y carraca 1/2"
- Juego vasos de puntas 1/2" y 3/8"
- Juego bits 1/2" y 3/8"
- Juego 10 llaves fijas
- Juego 16 llaves combinadas





**BlackLine**

690.00€

Carro de herramientas para mecánico con 7 cajones

Composición:

- Juego 4 alicates clips
- Juego 3 alicates (universal/ puntas/ corte)
- Juego 2 martillos y cinceles
- Juego 8 llaves destornilladores/ philips
- Juego 9 llaves macho hexagonal
- Juego 8 llaves torx dobles con mango
- Juego sierra, botadores y llave inglesa
- Juego alicate de presión y alicate ajustable
- Juego llaves vaso y carraca 1/4"
- Juego llaves vaso y carraca 1/2"
- Juego vasos de puntas 1/2" y 3/8"
- Juego bits 1/2" y 3/8"
- Juego 10 llaves fijas
- Juego 16 llaves combinadas
- Juego 8 llaves estrella codada 75°



**MECPROF1**

1 050.00€

**Carro de herramientas para mecánico con 6 cajones (C-6DWB1)**

Superficie de trabajo resistente a los golpes

Dimensiones: 670x460x960mm

## Composición:

- W26116SP 16 Laves
- P0803SP Juego de 3 alicates
- S04H4125SP Juego de llaves de vasos con 25 piezas de 1/2"
- D71PP08SP Juego de 8 destornilladores plano/ phillips
- AG010026SP Juego de mazos y cortafrios
- AG010002SP Juego de 4 alicates de clips
- P2710SP Juego de alicate conector y presión
- W25110SP Juego de 10 llaves fijas
- D70105SP Juego de 5 destornilladores plano/ phillips
- S06H427SP Juego 27 piezas puntas 1/2" y 3/8"
- M645114SP Juego sierra, llave inglesa y botadores
- W26121 Llave combinadas fija/ estrella de 21mm
- W26127 Llave combinadas fija/ estrella de 27mm
- W26130 Llave combinadas fija/ estrella de 30mm
- W26132 Llave combinadas fija/ estrella de 32mm
- JAT-6905B Kit pistola de aire
- AGO10035 Íman con luz y espejo
- MT0702 Cinta métrica
- ANO10009A Llave para tapón de cárter
- AGO10036 Bandeja magnética redonda
- D71P138 Llave phillips PH1x38mm
- D71S250 Destornillador plano 3x50mm
- AI060020 Galgas de espesor 20 hojas
- AI050009A Llave para filtro de aceite
- DBT31B Juego de puntas destornilladoras
- W6510810 Llave estrella 8x10mm
- W6511012 Llave estrella 10x12mm
- W6511315 Llave estrella 13x15mm
- W6511417 Llave estrella 14x17mm
 funda de aleta
- W6511922 Llave estrella 19x22mm
- P1516 Alicata de pelar
- S60H4304S Juego extensores de 1/2"
- S04H2118S Juego de llaves de vaso 1/4"
- H08MTP09S Juego llaves macho acodadas torx tamperproof
- AG010207 Lampara de inspección de LEDs SIN cable
- AH020002 Funda de aleta
- H01SM109S Juego 9 llaves macho 6 caras
- MKS27 Juego cutter con accesorios
- M07016 Martillo
- S44H2206 Adaptador



**ELECTR1**

890.00€

**Carro de herramientas para electricista con 6 cajones (C-6DWB5)**

Superficie tipo tablero con divisiones

Dimensiones: 670x460x960mm

Composición:

- AG010035 Ímán con luz y espejo
- AGO10036 Bandeja magnética redonda
- AH020002 Funda de aleta
- D71PP08SP Tablero con 8 destornilladores
- DV13PP07S Juego de 6 llaves aisladas y 1 buscapolos
- D3750M08S Juego 6 llaves de vasos de precisión
- D3750T18S Juego 8 destornilladores de precisión Torx
- H01SM109S Juego 9 llaves macho de 6 caras
- H10MT08SP Juego 9 llaves dobles torx con puño
- AGO10207 Lampara de inspección de LEDs SIN cable
- M04016 Mazo de bola
- M07016 Martillo
- MK2040 Cutter
- M63106S Juego de 6 botadores
- P0803SP Tablero con 3 alicates
- P2710 Alicata multitoma
- P5602 Mini alicata de corte
- P5605 Mini alicata de puntas
- S04H3157SP Juego carraca 1/4" y 3/8" con 56 dientes
- S57H108S Juego de 8 llaves de pipa
- V1401 Alicata de engatillar y pelar
- V1502 Alicata de pelar para trabajo intenso
- W26116SP Tablero 16 llaves combinada fija/estrella
- W6510810 Llave estrella 8x10 mm
- W6511012 Llave estrella 10x12 mm
- W6511315 Llave estrella 13x15 mm
- W6511417 Llave estrella 14x17 mm
- W6511922 Llave estrella 19x22 mm
- AN010068 Cepillo para limpieza de terminales
- P2205E Tijera electricista
- Hierro soldar 30 W
- Succionador soldadura
- Pinza puntas acodadas





**ELECTRO POWER HV**

1 350.00€

Carro de herramientas para electricista con composición flexible, adaptado a sus necesidades con 6 cajones (C-6DWB1) - a las 2 tableros del Tipo A (herramienta aislante a 1 000V), añade 2 tableros del Tipo B a su elección.

Dimensiones: 670x460x960mm



**Tableros Tipo A** (tableros de 1/2 cajón , incluidos en la composición)



**Tableros Tipo B** (tableros de cajón entero)

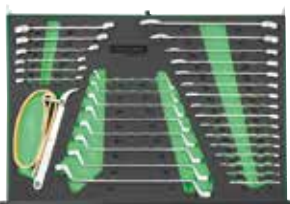

W2623431SV



D737128SV



H10121SV



D737134SV



P82736SV



P82714SV



W23559SV



D71157SV



W26134SV

**CHAPEIRO1**

880.00€

**Carro de herramientas para chapista con 4 cajones (C-4DWA1)**

Superficie de trabajo resistente a los golpes

Dimensiones: 670x460x795mm

Composición:

- AB030070B TAS de cuña simples
- AB030070C TAS abombado
- AB030070D TAS de coma
- AB030071 Martillo de recalcar
- AG010055 Destornillador de percusión con 4 puntas
- AG010140 TAS multiplo con mango
- AG010141 Empañadura para chapista con 10 puntas
- AG010142 Martillo para chapista con 9 puntas
- AG010143 Empuñadura con 15 cortafrios y botadores
- AS-0049V Máscara (caja 10 unid)
- D70PP10S Juego 10 destornilladores planos/phillips impacto
- D71PP16S Juego 16 destornilladores/phillips
- H02SM109S Juego 9 llaves hexagonales largas
- M06030 Mazo 1 550 gr
- M09500 Martillo genero mecánico
- M11045 Mazo antirebote moldeada de poliuretano
- MHS100AG Sierra
- MT0202 Cinta métrica 5 mt
- P817 Alicata universal
- P2212A Tijera corta chapa
- P32M10A Alicata presión
- P37M11A Mordaza cuello cisne
- P38M11A Mordaza para soldador
- S04H4524SP Juego llaves hexagonales con carraca
- W26112SP Juego 12 llaves inglesas mixtas/lupa 8-22 mm
- AB030068A Palanca de chapista 380 mm
- AB030068C Palanca de chapista 900 mm
- AB030068D Palanca de chapista 750 mm
- AB030068F Palanca de chapista 450 mm
- AB030069A Cuña de chapista 125 mm
- AB030069B Cuña de chapista 137 mm
- AB030069C Cuña de chapista 92 mm
- AB030069E Cuña de chapista 48 mm
- AG010024 Base para lima
- AG010024-2 Lima chapista
- A1030025 Rayador



**PINTOR16**

900.00€

**Carro de herramientas para pintor con 3 cajones (C-T3)**

Apertura superior

Dimensiones: 780x520x884mm

Composición:

- D71PP08SP Juego 8 destornilladores/phillips
- S04H3157SP Juego cabezales 56 piezas 1/4" y 3/8"
- MKS27 Juego cutter con accesorios
- AG010207 Lámpara de Leds sin cables
- MT0702 Cinta métrica 5 mt
- AB030060 Juego 2 alicates para grapas plásticas
- AB010026S Juego para quitar tapizados de plástico
- AB020019 Ventosas para colocación de tapizados
- AB030028 Llave de desgrapar
- AB030041 Llave de desgrapar
- AS-0049V Mascara (caja 10 unid)
- JAS-1031-6HE Lijadora orbital de 6"
- JA-HVLP-1080GK Pistola de pintura con accesorios
- JA-950 Pistola de secado



**MEC PESADOS**

Carro de herramientas con 6 cajones  
+ mango + bloque complementario

Composición:

- Juego de llaves 3/4" con carraca
- Juego de llaves 1/2" con carraca
- Juego de llaves inglesas/ phillips impacto
- Juego de 10 llaves Torx tamperproof largas
- Juego de 18 llaves hexagonales cortas
- Juego de 8 llaves de impacto hexagonales 1/2" punta macho
- Juego de sierra/ llave inglesa/ cinceles
- Juego 3 alicates (universal/ pontas/ corte)
- Juego de alicate de presión/ ajustables
- Juego de llaves estrella codada
- Juego de llaves mixtas
- Juego de llaves bocas
- Juego de alicates de frenos
- Juego de martillos y cinceles
- Juego de 40 bits
- Juego de llaves impacto 1/2"
- Galga de espesores

**MEC PESADOS A**

1 690.00€



**MEC PESADOS B**

1 585.00€



\* Composición:  
Carraca 1"  
10 llaves 36 a 80mm  
2 extendores de 200 y 400mm

**C-SA2**

2 500.00€

**Armario modular**

Dimensiones totales: 2 322x1 980x526mm  
 1 Módulo de armario vertical: 600x526x1980mm  
 1 Módulo 6 cajones: 861x500x994mm  
 1 Módulo 2 puertas: 861x500x994mm  
 2 Armarios superiores: 861x300x338mm  
 2 Paneles perforados: 861x20x338mm  
 1 Tapa madera: 1 725x480x40mm

**C-SA2S**

2 400.00€

**Armario Modular**

Dimensiones totales: 2 322x526x1 980mm  
 1 Módulo de armario vertical: 600x526x1 980mm  
 1 Módulo 6 cajones: 861x500x994mm  
 1 Módulo 2 puertas: 861x500x994mm  
 2 Armarios superiores: 861x300x338mm  
 2 Paneles perforados: 861x20x338mm  
 1 Tapa inox: 1 725x480x40mm

**C-SA3**

3 300.00€

**Armario modular**

Dimensiones totales: 2 998x526x1 980mm  
 1 Módulo de armario vertical: 600x526x1 980mm  
 1 Módulo 6 cajones: 861x500x994mm  
 1 Módulo 6 cajones: 676x500x994mm  
 1 Módulo 2 puertas: 861x500x994mm  
 1 Armario superior: 861x300x338mm  
 1 Armario superior: 676x300x338mm  
 2 Paneles perforados: 861x20x338mm  
 1 Panel perforado: 676x20x338mm  
 1 Tapa madera: 2 404x480x40mm

**C-SA3S**

3 200.00€

**Armario modular**

Dimensiones totales: 2 998x526x1 980mm  
 1 Módulo de armario vertical: 600x526x1 980mm  
 1 Módulo 6 cajones: 861x500x994mm  
 1 Módulo 6 cajones: 676x500x994mm  
 1 Módulo 2 puertas: 861x500x994mm  
 1 Armario superior: 861x300x338mm  
 1 Armario superior: 676x300x338mm  
 2 Paneles perforados: 861x20x338mm  
 1 Panel perforado: 676x20x338mm  
 1 Tapa inox: 2 404x480x40mm

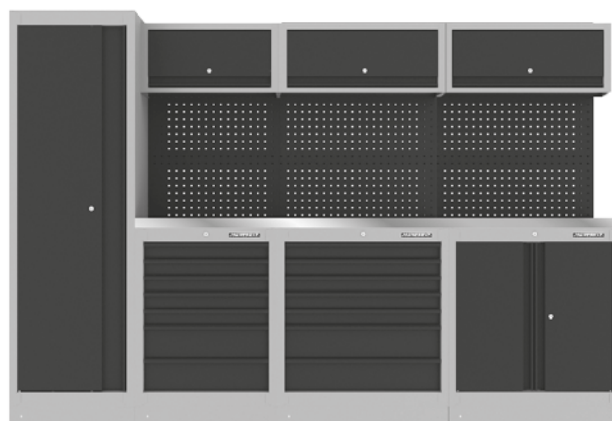



**C-4DWA1**

365.00€

**Carro vacío para herramientas con 4 cajones**

Superficie de trabajo especial

Dimensiones totales: 670x460x795mm

2 Cajones de 579x380x56mm

1 Cajón de 579x380x123mm

1 Cajón de 579x380x179mm



**C-7DB2**

Color: Negro 

350.00€

**Carro vacío para herramientas con 7 cajones**

Dimensiones totales: 670x460x960mm

5 Cajones de 576x380x75mm

2 Cajones de 576x380x154mm

**Color: negro**

Peso total: 60kg

Capacidad de carga: 40kg/rueda

Dimensión ruedas: 127x25,5mm



**C-6DWB1**

Color: Verde 

445.00€

**C-6DWB1G**

Color: Gris 

445.00€

**Carro vacío para herramientas con 6 cajones**

Superficie de trabajo especial

Dimensiones totales: 670x460x960mm

4 Cajones de 579x380x56mm

1 Cajón de 579x380x123mm

1 Cajón de 579x380x179mm



**C-6DWB5**

450.00€

**Carro vacío para herramientas con 6 cajones**

Superficie recubierta de plástico y soporte de herramienta

Dimensiones totales: 670x460x960mm

4 Cajones de 579x380x56mm

1 Cajón de 579x380x123mm

1 Cajón de 579x380x179mm



**C-7DW9**

550.00€

**Carro vacío para herramientas con 7 cajones**

Sistema de seguridad con apertura de 1 sólo cajón

Dimensiones totales: 670x460x960mm

5 Cajones de 576x380x75mm

2 Cajones de 576x380x154mm

Peso total: 74,5kg

Capacidad de carga: 75kg/rueda

Dimensión ruedas: 127x50,8mm



**C-7 TOWER**

710.00€

**Carro vacío con 13 cajones**

Dimensiones totales: 670x460x1334mm

5 Cajones de 576x380x75mm

2 Cajones de 576x380x154mm

Caja superior

3 Cajones de 170x275x50mm

2 Cajones de 569x275x50mm

1 Cajón de 569x275x75mm



**C-A16W**

299.00€

**Armario con 7 cajones**

Incluye 2 ruedas para el caso de acoplamiento con la C-7/ C-6

5 Cajones de 288x380x75mm

2 Cajones de 288x380x154mm



**C-A17W**

190.00€

**Armario con 1 puerta**

Incluye 2 ruedas para el caso de acoplamiento con la C-7/ C-6



**C-13DW53**

1 260.00€

**Carro grande vacío para herramientas con 13 cajones**

Dimensiones totales: 1 358x460x1 150mm

10 Cajones de 576x380x75mm

2 Cajones de 579x380x154mm

1 Cajón de 1 216x380x173mm

**C-10DW42**

999.00€

**Carro grande vacío para herramientas con 10 cajones**

Dimensiones totales: 1 070x460x981mm

1 Compartimento de almacenaje de 316x404x1 150mm

5 Cajones de 288x380x75mm

2 Cajones de 576x380x154mm

1 Cajón de 288x380x154mm

1 Cajón de 576x380x154mm

1 Cajón de 928x380x173mm

**C-T3**

345.00€

**Carro vacío para herramientas con 3 cajones**

Apertura superior

Dimensiones totales: 780x520x884mm

**C-T12**

130.00€

**Carro con 3 estantes**

Dimensiones totales: 716x410x880mm

Peso: 20kg

Ruedas: 4 (2 fijas+2 direccionales)

**C-5CD**

185.00€

**Caja de metal para herramientas con 5 maletas**

Dimensiones totales: 431x307x381mm

5 Maletas de 48x245x55mm

**C-6DA4**

190.00€

**Caja de metal vacía con 6 cajones para herramientas con 6 cajones**

Compartimento en la parte superior con varias particiones

Dimensiones totales: 660x307x374mm

3 Cajones de 172x270x41mm

2 Cajones de 572x270x31mm

1 Cajón de 572x270x65mm

**C-6DA494**

485.00€

**Caja de herramientas con 6 cajones - 98 piezas**

Compartimento en la parte superior con varias particiones

Dimensiones totales: 660x307x374mm

Composición:

AG10002SC

D376514SC

R4811SC

P0813SC

S04H5129SC

V11011SC

W25117SC

W27AT02SC

**C-3DH5**

99.00€

**Caja de metal vacía para herramientas con 3 cajones**

Compartimento en la parte superior

Dimensiones totales: 535x220x290mm

3 Cajones de 505x195x45mm



**C-3DH2**

49.00€

Caja de metal vacía para herramientas con 5 compartimentos  
Dimensiones totales: 470x220x350mm



**C-HA**

92.00€

Bolsa vacía para herramientas de tela sintética y asa de metal  
Dimensiones: 620x250x310mm



**C-HA78S**

370.00€

Bolsa para herramientas de tela sintética y asa de metal -  
78 piezas



**C-3DH262**

222.00€

Caja de metal para herramientas con 5 compartimentos - 62 piezas  
Dimensiones totales: 470x220x350mm  
Composición

- P106 Alicate de corte
- P116 Alicate de botas
- P087 Alicate universal
- D70 Juego 6 destornilladores/ phillips
- W26 Juego 18 llaves mixtas
- R2904 Carraca de 1/2"
- S04H41 Juego 18 llaves de vaso
- S15H472 Adaptador
- S24H4 Extensores
- S22H41450 Cable articulado 450mm
- S23H41300 Mango corredizo en T 300mm
- S21H4150 Extensión
- S17H4121 LLave de velas 21mm
- H03SM109S Juego llaves hexagonales



**Bolsas vacías y accesorios para carros**

**C-A456**

53.00€

Superficie de trabajo moldeado

Aplicables en los carros C-4/ C-6 e C-7



**C-A9**

38.50€

Base de tornillo de banco y soporte de rodillo de papel

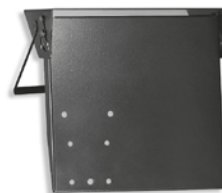

**C-A27**

36.00€

Encimera em acrílico para carros

Aplicables en los carros C-5DW/ C-6DW e C-7DW



**C-7DW1-TS**

70.00€

Encimera completa para carros

Aplicable solamente a los carros C-5DW/ C-6DW y C-7DW

Composición

- 1 Tapa acrílico resistente a los golpes
- 1 Base metálica de apoyo
- 1 Revestimiento EVA de 2mm



**C-A3**

12.00€

Asa de banco herramientas



## Bolsas vacías y accesorios para carros

### C-BS

Juego de carril derecho e izquierdo, para cajones de carros y cajas

Ref.	Aplicación	Precio
<b>C-BS Kit1</b>	Carros: C-4DW/ C-5DW/ C-6DW/ C-7DW	11.00€
<b>C-BS Kit2</b>	Cajas: C-6DA4	7.20€
<b>C-BS Kit3</b>	Carros: C-10DW/ C-13DW	12.50€



### C-PC

Cerradura de bloqueo

Ref.	Aplicación	Precio
<b>C-PC1</b>	C-DA4	4.30€
<b>C-PC2</b>	C-5/ C-6/ C-7	4.60€
<b>C-PC3</b>	C-4	7.50€



### C-WHEEL

Ruedas

Ref.	Tipo	Aplicación carro	Precio
<b>C-WHEEL1</b>	fija	C-6/ C-7	14.00€
<b>C-WHEEL2</b>	freno	C-6/ C-7	18.00€
<b>C-WHEEL5</b>	fija	C-5	12.00€
<b>C-WHEEL6</b>	freno	C-5	19.00€
<b>C-WHEEL8</b>	fija	C-T3/ C-/12	7.50€
<b>C-WHEEL9</b>	freno	C-T3/ C-/12	9.50€



### C-A

Tornillo de banco

Ref.	Tipo	Apertura (mm)	Precio
<b>C-A7*</b>	3"	76	62.00€
<b>C-A8*</b>	4"	101	71.00€
<b>C-A10</b>	5"	127	91.00€
<b>C-A11</b>	6"	152	111.00€
<b>C-A12</b>	8"	203	140.00€
<b>C-A13</b>	10"	254	199.00€



\* Aplicable en carro de herramienta (necesario soporte C-A9)



**JONNESWAY®**

**Otros Equipos**



**Otros equipos**

**AE020009**

320.00€

**Bomba hidroneumática**

Operación presión: 690bar  
 Alimentación: 7-10bar  
 Dimensiones: 257,50x127x204,50mm  
 Peso: 8 000g  
 Capacidad: 1 660cc



**AE060002**

550.00€

**Gato hidráulico para transmisiones**

Altura máxima: 750mm  
 Altura mínima: 200mm  
 Capacidad: 1t  
 Dimensiones: 865x480mm  
 Peso: 60kg



**AE060003**

999.00€

**Gato hidráulico para transmisiones**

Altura máxima: 890mm  
 Altura mínima: 165mm  
 Capacidad: 1,5t  
 Dimensiones: 1 105x652mm  
 Peso: 130kg



**AE070002A**

420.00€

**Gato hidráulico de foso**

Altura máxima: 1 835mm  
 Altura mínima: 1 035mm  
 Capacidad: 600kg

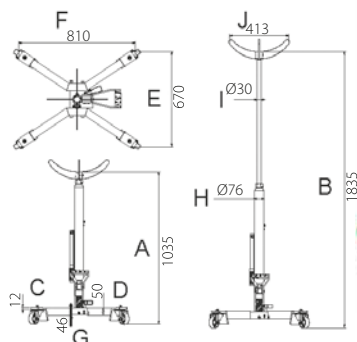

**AE080001**

585.00€

**Gato de foso con plato universal**

Altura máxima: 1 377mm  
 Altura mínima: 880mm  
 Capacidad: 500kg  
 Plato: 729x597mm

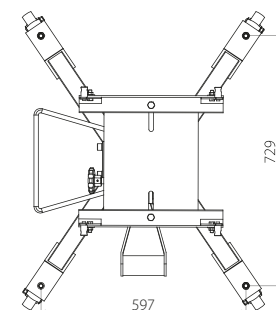
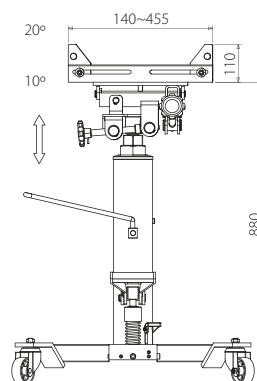
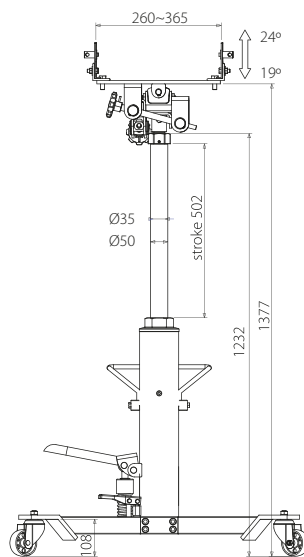

**AE090025**

420.00€

**Gato hidráulico de anchura reducida en aluminio**

Altura máxima: 445mm  
 Altura mínima: 87mm  
 Capacidad: 2 000kg



**AG010154**

12.50€

**Banco plástico de soporte con ruedas**

Dimensiones: 450x335x310mm  
 Peso: 1 500g



**AG010219**

99.00€

**Banco metálico con ruedas**

Dimensiones: 350x260x240mm  
 Capacidad: 150kg

Incluye: Cajón  
 Soporte lateral piezas  
 Panel lateral apoyo



**AG010222**

73.00€

**Banco metálico con ruedas**

Dimensiones: 330x350x560mm  
 Capacidad: 130kg

Incluye: Cajón  
 Soportes laterales piezas



**AE090105A**

48.00€

**Camilla para mecánico**

Dimensiones: 1 000x500x100mm



**AE110020**

880.00€

**Gato hidráulico**

Altura máxima: 377mm  
 Altura mínima: 205mm  
 Capacidad: 20t

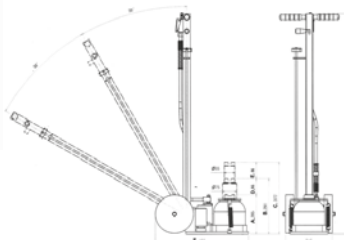

**AE130003**

710.00€

**Grua hidráulica de 2t**

Medidas en mm:  
 Altura mínima: 60  
 Elevación máxima: 2 330  
 Longitud de la base: 718-936  
 Longitud de la base: 1 606-2 426  
 Longitud máxima brazo: 1 960



**AE130003-1**

80.00€

**Travesaño para soporte de motores para grúa**

Capacidad: 500kg



**AE140013**

620.00€

Soporte de motores articulado

Capacidad: 600kg



**AE150001**

163.00€

Caballete

Altura: 710-1 065mm

Capacidad: 12t



**AE150002**

145.00€

Caballete

Altura: 456-710mm

Capacidad: 12t



**AE170002**

118.00€

Travesaño para soporte de motores

Ajuste: 530-1 480mm



**AE010025A**

265.00€

Gato hidráulico para chapistas de 4t

Composición:

Bomba hidráulica manual  
Cilindro hidráulico: 4t (369-522mm)  
Abrazadera de extensión  
Adaptadores  
Extensiones  
Maletín con ruedas



**AE010015A**

445.00€

Gato hidráulico para chapistas de 10t

Composición:

Bomba hidráulica manual  
Cilindro hidráulico: 10t (369-522mm)  
Abrazadera de extensión  
Adaptadores  
Extensiones  
Maletín con ruedas



**AE050003**

140.00€

Gato chapista 5t

Capacidad: 5t

Longitud: 750mm

Longitud del émbolo: 160mm



**AE180001**

164.00€

Barras para puertas

Longitud: 74-115mm





**AE200003**

980.00€

**Elevador de vehículos pesados**

Capacidad: 600kg  
Elevación: 395 mm



**AE300025**

270.00€

**Aspirador de aceite**

Con bomba neumática, sondas de succión y el indicador de nivel de aceite.

Capacidad: 16l  
Peso: 9 kg  
Dimensiones: 310x330x1 020mm



**AE300149**

135.00€

**Recogedor de aceite**

Recogedor ajustable en altura en polietileno de alta densidad con descarga por gravedad.

Capacidad: 50l  
Peso: 12kg  
Dimensiones: 550x550x990~1 070 mm



**AR020016**

80.00€

**Multímetro digital y analizador auto**

Funciones: RPM, dwell, volts Ac/DC, amps DC, resistencia, ciclo de trabajo, temperatura, prueba de diodos, prueba continuidad.



**AR020059**

183.00€

**Termómetro de infrarrojos para A/C**

Se apaga automáticamente.

Salida RS232 para conexión a PC (software no está incluido)

Rango de medición: -20 a 400°C; -4 a 75°F  
Resolución: 0,1°C



**AR020059B**

36.00€

**Conexión del cable al PC**

**AR020059C**

14.00€

**Software no incluido**

**AR020060**

199.00€

**Pinza amperimétrica**

De conformidad con la norma IEC 1010 CAT III 1 000V

Multímetro digital con balanzas automáticas  
Multifunción para AC/DV amp; AC/DC V e Ohms  
Capacitancia, frecuencia y diodos  
Protección de sobrecarga

Memoria  
RMS (valor eficaz)

Pinza amperimétrica: 2 000A - AC7DC  
Intervalo de medición: 2 000 A AC/400A DC



**AR020061**

150.00€

**Multímetro digital**

De conformidad con la norma IEC 1010 CAT III 1 000V

Pantalla grande  
Balanzas automáticas AC/DC para voltaje, amperaje, capacidad, frecuencia, resistencia  
Lectura hasta 10 Amp com protección y impedancia alta para lecturas de mV  
Memoria  
RMS (valor eficaz)



**JEI-0004S**

385.00€

Llave eléctrica de impacto 1/2" sin hilos

Características:

Torque máximo:

Voltaje:

Batería:

Peso:

Composición:

JEI-0004

JEZ-18D

JEZ-01

550Nm

18.0 V DC

iones de litio

2 180 g (sin batería)

Máquina sin hilos

Batería

Cargador

LLaves de impacto 1/2":

17; 18; 19 y 21mm



**JEZ-18D**

117.00€

Batería para llave JEI-0004



**C-T4A**

435.00€

Mesa de trabajo gris con 3 cajones

Cubierta metálica con cobertura en acrílico

Medidas:

Altura: 800mm

Profundidad: 700mm

Ancho: 1 525mm



**C-T5G-DP**

92.00€

Panel trasero gris para banco de trabajo

Medidas:

Altura: 700mm

Ancho: 1 525mm

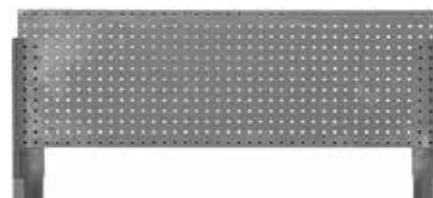

**C-DBU1**

1.00€

Gancho para panel trasero de banco de trabajo





**JONNESWAY**®

# Herramientas Manuales



Tableros para  
herramienta



Destornilladores



Herramienta  
manual



Martillos



Alicates



Varios



**AG010002SP**

46.00€

**Juego de 4 alicates de clips**

Composición:

- AG010002 Alicates de clips interiores
- AG010005 Alicates de clips interiores de punta acodada
- AG010008 Alicates de clips exteriores
- AG010011 Alicates de clips exteriores de puntas acodadas 90°

**A**



**AG0100026SP**

48.00€

**Juego de martillos y cincel**

Composición:

- M09300 Martillo de mecánico 300g
- M11035 Mazo moldeado poliuretano 400g
- M61 Juego de 3 cincelos

**A**



**AG010150SC**

95.00€

**Juego de 8 alicates de clips**

Composición:

- 4 Alicates de puntas rectas
- 4 Alicates de puntas curvas

**B**



**AG10001SP**

102.00€

**Juego de machos y terrajas**

Composición:

- 17 Machos de rosca manuales: M3 a M12
- 17 Terrajas: M3 a M12
- 1 Porta terrajas
- 1 Reparador de machos
- 1 Mango reparador

**B**



**AI10001SP**

180.00€

**Juego de herramientas para reemplazar válvulas de culata**

Composición:

- AN010064 Compresor de válvulas de culata
- AI020056 Alicates para sellos de válvulas
- AI020099 Adaptador resortes de válvulas
- AI020100 Apoyo de válvulas
- AI010012A Extractor de asientos de válvulas

**B**



**AI10002SP**

148.00€

**Juego de herramientas para reemplazar polea del cigüeñal**

Composición:

- AE310030 Desmontable de 2 patas
- AE10035-1 Adaptador para 3 patas
- AN010038 Extractor sello
- AI020087A Extractor polea del cigüeñal

**B**



**AI10003SP**
**117.00€**
**Juego de llaves de vaso para filtros y cárteres**

Composición:

- 9 Llaves de vaso para filtros
- 14 Llaves para tapón del cárter
- 1 Llave universal para filtros

**B**

Description		
○ 8mm	BMW Ford	△ 10mm Renault
○ 9mm	General Motor	T-Bar To Drive
○ 10mm	Ford	30-160mm Oil Filter Chain 3/8" Oil
○ 12mm	Fiat, Lancia, Peugeot	Filter Cap Wrench
○ 14mm	Mercedes, Lancia	93mm-15 GM, Nissan, Volvo, Mazda, Audi, VW, etc.
○ 17mm	BMW, Austin, Audi, VW	76mm-14 VW, Porsche, Mercedes, BMW, Toyota
○ 3/8"	General Motor	75,6mm-14 Mazda, General Motor
□ 10mm	BMW, Renault, Toyota	38mm etc Diesel Engine
□ 8mm	Citroen, Peugeot, Renault, Talbot, Volvo	36mm Benz, VW, BMW/M52, M60, M73
□ 11mm	Ford	32mm GM, Saab, Saturn
□ 13mm	Nissan, Subaru	30mm General Motor
□ 3/8"	Honda, Mazda, Renault, Saab, Volvo	27mm Mercedes
□ 7mm	General Motor	24mm BMW/ 5 & 7 series

**AN10002SP**
**188.00€**
**Juego de 27 piezas de herramienta para frenos**

Este tablero ocupa la mitad de cajones del carro de herramientas.

**C**

**D70105SP**
**34.50€**
**Juego de 5 llaves destornilladores/ phillips**

Composición/ medidas en mm:

- |             |                     |             |                    |
|-------------|---------------------|-------------|--------------------|
| <b>D70S</b> | 3 Destornilladores: | <b>D70P</b> | 2 Llaves phillips: |
|             | 6x100               |             | 2x100              |
|             | 6x150               |             | 3x150              |
|             | 8x150               |             |                    |

**A**

**D71PP08SP**
**32.00€**
**Juego de 8 llaves destornilladores planos**

Composición/ medidas en mm:

- |             |                     |             |                    |
|-------------|---------------------|-------------|--------------------|
| <b>D71S</b> | 4 Destornilladores: | <b>D71P</b> | 4 Llaves phillips: |
|             | 6,5x38              |             | 2x38               |
|             | 4x80                |             | 1x80               |
|             | 5,5x125             |             | 2x100              |
|             | 6,5x150             |             | 3x150              |

**A**

**D725N08SP**
**67.00€**
**Juego de 8 llaves destornilladores de boca métrica con mango**

Composición:

- Llaves de 6 a 13mm

**C**

**H10MB08SP**
**32.50€**
**Juego de 8 llaves macho allen con puntas esférica con mango**

Composición/ medidas en mm:

- |              |         |        |
|--------------|---------|--------|
| <b>H10MB</b> | 2x100   | 5x150  |
|              | 2,5x100 | 6X150  |
|              | 3x100   | 8X200  |
|              | 4x100   | 10X200 |

**B**

**H10MT08SP**
**34.50€**
**Juego de 8 llaves torx dobles tamperproof con mango**

Composición/ medidas en mm:

- |              |         |         |
|--------------|---------|---------|
| <b>H10MT</b> | T10x100 | T27x150 |
|              | T15x100 | T30X150 |
|              | T20x100 | T45X200 |
|              | T25x100 | T50X200 |

**B**

**H20MT08SP**
**40.00€**
**Juego de 8 llaves torx dobles con mango**

Composición/ medidas en mm:

- |  |         |         |
|--|---------|---------|
|  | T10x110 | T27x145 |
|  | T15x120 | T30X155 |
|  | T20x125 | T45X185 |
|  | T25x135 | T50X205 |

**B**

**M09513SP** 70.00€

Juego de 2 martillos y botadores

Composición:

- M07016 Martillo con punta de goma
- M09500 Martillo de mecánico
- M63M106S Juego botadores cromo
- M64M105S Juego botadores y cortafrios cromo



**M645114SP** 72.50€

Juego de sierra, llave inglesa, botadores y cortafrios

Composición:

- M63 6 Botadores
- M64 4 Cortafrios
- W27AS10 Llave inglesa
- MHS100AG Sierra



**MTC101SP** 199.00€

Juego de herramienta de medición

Composición/ medidas en mm:

- Calibre 150
- Pieza de metal 300
- Regla de metal 300
- Compás 200
- Micrómetro 0-25
- Micrómetro 25-50
- Lápiz



**P018SP1** 53.00€

Juego de 3 alicates y 7 llaves de allen

Composición:

- P018 Alicate universal
- P038 Alicate de corte diagonal
- P068 Alicate de puntas
- H01SM109S Llaves de 6 caras



**P018SP** 45.00€

Juego de 3 alicates

Composición:

- P018 Alicate universal
- P038 Alicate de corte diagonal
- P068 Alicate de puntas



**P04704SP** 54.50€

Juego de 4 alicates de corte

No usar en metal



**P0803SP** 40.50€

Juego de 3 alicates aislados

Composición:

- P087 Alicate universal
- P097 Alicate de corte diagonal
- P118 Alicate de puntas



**P0903SP** 51.50€

Juego de 3 alicates aislados

Composición:

- P0817 Alicate universal
- P1017 Alicate de corte diagonal
- P1118 Alicate de puntas



**P2710SP** 31.00€

Juego de 2 alicates de agarre

Composición:

- P2710 Alicate ajustable
- P32M10A Alicate de presión



**P2803SP**
**49.00€**
**Juego de 2 alicates y llave inglesa**

Composición:

**W27AS10** Llave inglesa  
**P2810** Alicata ajustable  
**P32M10A** Alicata de presión

**A**

**S03A4122SP**
**75.50€**
**Juego de 22 llaves de impacto 1/2"**

Composición/ medidas en mm:

**S03A4** Llaves: 10; 11; 12; 13; 14; 16; 17; 19; 21; 22 y 24  
**S03AD4** Llaves: 10; 11; 12; 13; 14; 16; 17; 19; 21; 22 y 24

**A**

**S04H2125SP**
**46.00€**
**Juego de llaves de vaso con 24 piezas de 1/4"**

Composición/ medidas en mm:

**R3702** Trinquete de 48 dientes  
**S04H2** Llaves de vaso: 4; 5; 5,5; 6; 7; 8; 9; 10; 11; 12 y 13  
**S04HD2** Llaves de vaso: 5; 6; 7; 8; 9; 10; 11; 12 y 13  
**S24H250** Extensión 50  
**S24H2150** Extensión 150  
**S26H2150** Mango

**A**

**S04H3157SP**
**116.00€**
**Juego de 8 llaves de vaso con 56 piezas de 1/4" y 3/8"**

Composición/ medidas en mm:

**R3702** Trinquete 1/4" de 48 dientes  
**S04H2** Llaves 1/4": 4; 4,5; 5; 5,5; 6; 7; 8; 9; 10; 11; 12 y 13  
**S04HD2** Llaves 1/4": 8; 10; 12 y 13  
**S09H2** Puntas allen: 3; 4; 5 y 6  
**S11H2** Puntas torx: T10; T15; T20; T25; T27 y T30  
 Puntas planas: 4; 5,5 y 7  
 Puntas phillips: PH1; PH2 y PH3  
**S24H2** Extensores  
 Adaptador extensible  
**S16H302** Adaptador universal  
 Mango  
**R3703** Trinquete 3/8" de 48 dientes  
**S04H3** Llaves 3/8": 14; 15; 17; 18; 19; 20; 22 y 24  
**S04HD3** Llaves 3/8": 14; 15 y 17  
**S17H3** Vasos de bujías: 16 y 21  
**S24H3** Extensores  
 Adaptador extensible 3/8" - 1/2"  
**S15H356** Adaptador universal

**B**

**S04H3536SP**
**89.50€**
**Juego de llaves de vaso 7 llaves mixtas con 36 piezas de 3/8"**

Composición/ medidas en mm:

**R3403** Trinquete de 72 dientes  
**S04H3** Llaves de vaso: 6 a 22  
**S24H3** Extensores  
 Adaptador extensible 1/2" - 3/8"  
**S17H3** Vasos de bujías: 16 y 21  
**S15H356** Adaptador universal  
**W26** Llaves de vasos fija/ estrella: 7 a 17

**B**

**S04H4125SP**
**83.00€**
**Juego de llaves de vaso con 25 piezas de 1/2"**

Composición/ medidas en mm:

**R3704** Trinquete de 48 dientes  
**S04H4** Llaves: 10; 11; 12; 13; 14; 15; 16; 17; 18; 19; 20; 21; 22; 23; 24; 27; 30 y 32  
**S24H4** Extensores  
**S17H4** Vasos de bujías: 16 y 21  
**S23H4125** Mango corredizo en T  
**S15H472** Adaptador universal

**B**

**S04H4131SP**
**123.00€**
**Juego de llaves y trinquete con 31 piezas de 1/2"**

Composición/ medidas en mm:

- Trinquete de 72 dientes
- Llaves de vaso: 10 a 32
- Vasos de bujías: 16 y 21
- Cardán
- Extensor de 125
- Extensor de 250
- Mango corredizo en T de 250
- Puntas allen de 5; 6; 8; 10 y 12

**C**

**S04H4524SP**
**98.00€**
**Juego de llaves de vaso 6 caras con 24 piezas de 1/2"**

Composición/ medidas en mm:

- R3704 Trinquete de 48 dientes
- S04H4 Llaves: 10; 11; 12; 13; 14; 15; 16; 17; 18; 19; 20; 21; 22; 23; 24; 27; 30 y 32
- S24H4 Extensores 5" y 10"
- S15H472 Adaptador universal
- S22H41375 Mango flexible 15"
- S23H41300 Mango corredizo en T

**B**

**S04H4726SP**
**103.00€**
**Juego de llaves de vaso con 26 piezas de 1/2"**

Composición/ medidas en mm:

- R3704 Trinquete de 48 dientes
- S04H4 Llaves de vaso: 12; 13; 14; 15; 16; 17; 18; 19; 20; 21; 22; 23; 24; 25; 26; 27; 28; 30 y 34
- S24H4 Extensores 5" y 10"
- S17H4116 Vasos de bujías 16
- S15H472 Adaptador universal
- S23H41300 Mango corredizo en T
- S41H4 Manivela de mango de metal

**B**

**S04H4728SP**
**98.50€**
**Juego de llaves de vaso 6 caras con 28 piezas de 1/2"**

Composición/ medidas en mm:

- R3704 Trinquete de 48 dientes
- S04H4 Llaves de vaso: 8; 9; 10; 11; 12; 13; 14; 15; 16; 17; 18; 19; 20; 21; 22; 23; 24; 25; 26; 27; 28; 30; 32 y 34
- S24H4250 Extensor 10"
- S15H472 Adaptador universal
- S23H41300 Mango corredizo en T

**B**

**S06H427SP**
**78.00€**
**Juego de llaves de vaso allen con 27 piezas de 1/2" y 3/8"**

Composición:

- S09H4 Puntas 6 caras de 1/2"
- S49H4 Puntas estriados de 1/2"
- S09H3 Puntas 6 caras de 3/8"

**A**

**S09H4118SP**
**56.00€**
**Juego de llaves de vaso allen 6 caras con 18 piezas de 1/2" y 3/8"**

Composición:

- Llaves 55mm: H5; H6; H7; H8; H10; H12; H14; H17 y H19
- Llaves 100mm: H5; H6; H7; H8; H10; H12; H14; H17 y H19

**A**

**S29H4140SP**
**40.00€**
**Juego 40 puntas de 3/8" para boquilla de 1/2" y 3/8"**

Composición:

- Puntas 6 caras
- Puntas torx
- Puntas estriados
- Soporte puntas

**A**



**V1310SP** 135.00€

Juego de alicates de engatillar y pelar cables

Composición:

- V1310 Alicates de engatillar terminales aislados y no aislados
- V1401 Alicates para pelar cables
- AG010031A Imán con espejo
- Test para circuitos
- Kit con 60 terminales

**B**



**W23108SP** 51.00€

Juego de 8 llaves de estrella acodadas 75°

Composición/ medidas en mm:

- W23 Llaves: 6x7; 8x9; 10x11; 12x13; 14x15; 16x17; 18x19 y 20x22

**A**



**W24A109SP** 125.00€

Juego de 9 llaves de estrella acodadas abierta y flexible

Composición/ medidas en mm:

- W24A Llaves: 8x8; 10x10; 11x11; 12x12; 13x13; 14x14; 17x17; 19x19 y 22x22

**A**



**W25110SP** 49.00€

Juego de 10 llaves fijas

Composición/ medidas en mm:

- W25 Llaves: 6x7; 8x9; 10x11; 12x13; 14x15; 16x17; 18x19; 21x23; 24x27 y 30x32

**A**

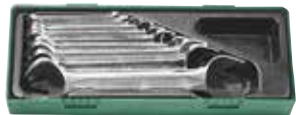

**W26112SP** 46.50€

Juego de 12 llaves combinadas fija/ estrella

Composición/ medidas en mm:

- W26 Llaves: 8; 9; 10; 11; 12; 13; 14; 15; 16; 17; 19 y 22

**A**



**W26116SP** 62.00€

Juego de 16 llaves combinadas fija/estrella

Composición/ medidas en mm:

- W26 Llaves: 6; 7; 8; 9; 10; 11; 12; 13; 14; 15; 16; 17; 18; 19; 22 y 24

**B**



**W45112SP** 133.00€

Juego de 12 llaves combinadas fija/ trinquete de 72 dientes

Composición/ medidas en mm:

- W45 Llaves: 8 a 19

**A**



**W47108SP** 70.50€

Tablero de 8 llaves de estrella acodada angular con trinquete

Composición/ medidas en mm:

- W47 Llaves: 6x7; 8x9; 10x11; 12x13; 14x15; 16x18; 17x19 y 21x22

**A**



**W60115SP** 177.00€

Juego de 15 llaves fijas/ trinquete reversible de 72 dientes

Composición/ medidas en mm:

- W60 Llaves: 9 a 19
- Adaptadores de 1/4"; 3/8" y 1/2"
- Soporte puntas de 10

**B**



**W70A118S** 220.00€

Juego de llaves en T con trinquete articulados

Composición/ medidas en mm:

- W60 Llave en "T" de 300
- Llave en "T" de 50
- Llave con trinquete de 72 dientes
- Extensor de 3"
- Extensor de 6"
- Adaptador 3/8" (F)x3/8" (F)

**B**



**JA-C131SV**

570.00€

Cajón completo para servicio de neumáticos (cajón completo)

Composición:

- JAI-0924 Pistola neumática de 1/2"
- JAR-6309A Trinquete neumático de 1/2"
- JAG-0906R Esmeriladora neumática de 1/4"
- Llaves de impacto largo de 1/2"
- Llaves de impacto de 1/2"
- Adaptador de 3/8"-1/2"
- Adaptador de 1/2"- 3/8"
- Adaptador de 1/2"-3/4"
- Cardán de 1/2"
- Extensores de 1/2"

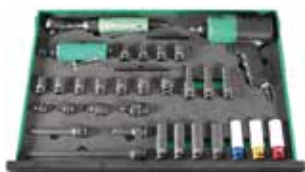

**D71157SV**

187.00€

Cajón con destornilladores, llaves phillips, alicates y bits (cajón completo)

Composición/ medidas en mm:

- Destornilladores: 6,5x38; 4x80; 5,5x125 y 6,5x150
- Llaves phillips: PH2x38; PH1x80; PH2x100 y PH3x150
- Destornilladores/ de golpe: 6,5x125; 8x150 y 9,5x175
- Llaves phillips/ de golpe: PH2x100 y PH3x150
- Bits hexagonales: 4; 5; 6; 7; 8; 10 y 12 de 30 y 75mm de longitud
- Bits torx: T20; T25; T30; T40; T45; T50 y T55 de 30 y 75mm de longitud
- Bits XZN: M5; M6; M8; M10 y M12 de 30 y 75mm de longitud
- Porta bits de 3/8" y 1/2"
- Alicates de frenos



**D737128SV**

176.00€

Cajón con destornilladores/ llaves phillips (cajón completo)

Composición:

- D71PP08SP Juego de destornilladores/ phillips
- D70105SP Juego de destornilladores/ phillips pancada
- M645114SP Juego de sierra, llave inglesa, botadores y cortafrios



**D737134SV**

177.00€

Cajón con destornilladores/ llaves phillips (cajón completo)

Composición:

- D3750P065S Juego de llaves de precisión
- D3750T08S Juego de llaves de precisión
- D70105SP Juego de destornilladores/ phillips pancada
- D71PP08SP Juego de destornilladores/ phillips
- W43A106S Juego de llaves de vaso flexible



**H10121SV**

137.00€

Cajón con llaves macho allen con mango, cincel y martillos (cajón completo)

Composición:

- H10MB08S Juego de llaves dobles allen con mango
- H10MT08S Juego de llaves dobles torx tamperproof con mango
- AG010026S Juego de martillos y cincel



**P82714SV**

211.00€

Cajón con alicates (cajón completo)

Composición:

- P018SP Juego de alicates
- P2710SP Juego de alicates
- AG010002SP Juego de alicates de clips
- P71 Juego de mini alicates



**P82736SV**

228.00€

Cajón con alicates y vasos de puntas (cajón completo)

Composición:

- S06H427SP Juego de vasos de puntas de 1/2" y 3/8"
- AG010002SP Juego de alicates de clips
- P018SP Juego de alicates
- P2710SP Juego de alicates



**S04H2184SV**

**175.00€**

**Cajón con 74 piezas de 1/4"** (cajón completo)

Composición:

- Trinquete de 1/4"
- Llaves de vaso de 1/4": 4 a 14mm
- Bits de caja hexagonales de 1/4": H2 a H6
- Adaptador 3/8"(F) x 1/4" (M)
- Adaptador 1/4" (M) x 3/8" (F) para cable en "T" corredizo
- Cardán de 1/4"
- Extensores de 1/4": 100mm y 150mm
- Manivela 1/4": 150mm
- Cable en T corredizo de 1/4": 130mm
- Mango de 1/4" con función fija/ cardán 280mm
- Extensor flexible de 1/4": 145mm
- Bits phillips, destornillador, pozidrive, hexagonales, torx
- Llaves de precisión destornillador/ phillips
- Destornillador/ impacto 9,5x200mm y 9,5x300mm
- Destornillador 5x150mm
- Destornillador aislado 1000V 5,5x125mm

**D**

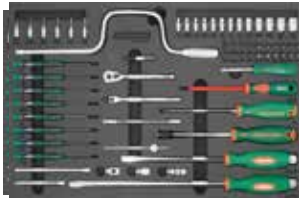

**S04H3194SV**

**215.00€**

**Cajón con 94 piezas de 1/4" y 3/8"** (cajón completo)

Composición:

- Trinquete de 1/4"
- Llaves de vaso de 1/4": 5 a 14mm
- Bits de caja destornilladores de 1/4": 3,5; 5,5 y 7mm
- Bits de caja hexagonales de 1/4": H3, H4, H5, H6 y H7
- Bits de caja phillips de 1/4": PH1; PH2 y PH3
- Bits de caja torx interior de 1/4": E4; E5; E6; E7 y E8
- Bits de caja torx de 1/4": T10; T15; T20; T25; T30; T35 y T40
- Mango de 1/4" con función fija/ cardán 280mm
- Bits torx tamperproof con encaixe de 1/4": T7 a T40
- Bits phillips con encaje de 1/4": PH1; PH2 y PH3
- Cable en T corredizo de 1/4": 115mm
- Extensor de 1/4": 150mm
- Cardán de 1/4"
- Juego de bits de 1/4"
- Bit torx tamperproof de 3/8": T55
- Trinquete de 1/4" de 36 dientes
- Adaptador 3/8" x 1/4"
- Llaves de vaso 3/8": 7 a 22mm
- Llaves torx interior 3/8": E10; E12 y E14
- Llave torx 3/8": T40
- Bits caja XZN 3/8": M6; M8 y M10
- Extensores 3/8": 75mm y 150mm
- Trinquete y trinquete flexible de 3/8" con 36 dientes
- Cardán de 3/8"
- Adaptador 1/4" (F) x 3/8" (M)

**D**



**S04H42165SV**

**227.00€**

**Cajón con 65 piezas de 1/4" y 1/2"** (cajón completo)

Composición:

- Trinquete de 1/4" de 48 dientes
- Llaves de vaso 1/4": 4 a 13mm
- Llaves de vaso largas de 1/4": 5 a 13mm
- Extensores de 1/4": 50mm y 150mm
- Mango de 1/4"
- Trinquete de 1/2" de 48 dientes
- Llaves de vaso 1/2": 10 a 32mm
- Vasos de bujias 1/2": 16 y 21mm
- Extensores de 1/2": 125mm y 250mm
- Cable en T corredizo
- Cardán de 1/2"
- Llaves mixtas de 6 a 24mm

**D**



**S04H4295SV**

**217.00€**

**Cajón con llaves de vaso y trinquete** (cajón completo)

Composición:

- S04H2125SP Juego llaves de vaso con 25 piezas de 1/4"
- S04H4131SP Juego llaves de vaso con 31 piezas de 1/2"
- S29H4140SP Juego de 40 puntas de 1/2" y 3/8"

**D**



**S04H46121SV**

**305.00€**

**Cajón con llaves de vaso y trinquete** (cajón completo)

Composición:

- S04H3157SP Juego de llaves de vaso con trinquete de 1/4" y 3/8"
- S04H4125SP Juego de llaves de vaso con trinquete de 1/2"
- S29H4140SP Juego de 40 puntas de 1/2" y 3/8"

**D**



## Tableros para herramienta

### Tableros en espuma de alta densidad EVA

**W23559SV**

202.00€

Cajón con destornilladores/ phillips/ estrella y alicates (cajón completo)

Composición:

D71PP08SP Juego de destornilladores planos y phillips

W23108SP Juego de llaves estrella acodadas 75°

P0903SP Juego de alicates

S29H4140SP Juego de puntas de 1/2" y 3/8"

D



**W26134SV**

197.00€

Cajón con llaves de estrella/ mixtas/ alicates (cajón completo)

Composición:

W23108SP Juego de estrella acodadas 75°

P0903SP Juego de alicates

W26112SP Juego de llaves combinadas (fijas/ estrella)

H015M109S Juego de llaves hexagonales

P28210 Alicata ajustable

P32M10A Alicata de presión

D



**W2623431SV**

189.50€

Cajón con llaves de estrella y mixtas (cajón completo)

Composición:

W23108SP Juego de estrella acodadas 75°

W24106S Juego de llaves estrella abierta

W23108SP Juego de alicates

A1050077 Correa para filtros de aceite

D

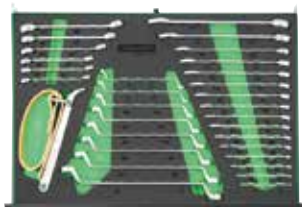

**D71PP08KV**

189.50€

Tablero con 8 destornilladores planos/ phillips (1/3 de cajón)

Composición:

D71S Juego de 4 destornilladores planos  
6,5x38; 4x80; 5,5x125 y 6,5x150mm

D71P Juego de 4 destornilladores phillips  
PH1X80; PH2X38; PH2x100 y PH3x150mm

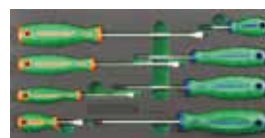

**H10MB08KV**

46.00€

Tablero con 8 chaves hexagonais de punho (1/3 de cajón)

Composición:

H10MB Jogo de 8 llaves macho  
2x100; 2,5x100; 3x100; 4x100; 5x150; 6x150, 8x200  
y 10x200mm

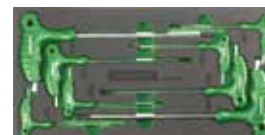

**H10MT08KV**

45.50€

Tablero con 8 llaves torx tamperproof de puño (1/3 de cajón)

Composición:

H10MT Juego de 8 llaves torx  
T10x100; T15x100; T20x100; T25x100; T27x150;  
T30x150; T45x200 y T50x200mm



**M09103KV**

60.00€

Tablero con martillos y llave inglesa (1/3 de cajón)

Composición:

M09300 Martillo tipo alemán

M11035 Martillo de goma (anti rebote)

W27AS10 Llave inglesa



**M63113KV**

63.00€

Tablero con botadores, cortafíos, buril y punzón (1/3 de cajón)

Composición:

- 6 Botadores
- 4 Cortafíos
- 1 Buril
- 1 Punzón de pico
- 1 Punzón



**MHS08KV**

68.00€

Tablero con sierra e vários (2/3 de cajón)

Composición:

- 1 Sierra con 2 láminas extra
- 1 Cinta métrica 3 mts
- 1 Regla 330mm
- 1 Cutter



**P011804KV**

74.00€

Tablero con 4 alicates (1/3 de cajón)

Composición:

- P0817 1 Alicata universal
- P1017 1 Alicata de corte diagonal
- P1118 1 Alicata de puntas
- P2710 1 Alicata ajustable

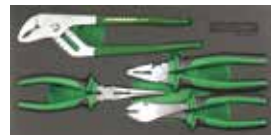

**P32M105KV**

72.00€

Tablero con 5 alicates (1/3 de cajón)

Composición:

- AG010002 1 Alicata circlips interiores recto
- AG010005 1 Alicata circlips interiores curvo
- AG010008 1 Alicata circlips exteriores recto
- AG010011 1 Alicata circlips exteriores curvo
- P32M10A 1 Alicata de bloqueo



**S03A4122KV**

97.00€

Tablero con 22 llaves de impacto 1/2" (1/3 de cajón)

Composición:

- S03A Juego llaves impacto  
10; 11; 12; 13; 14; 16; 17; 19; 21; 22 y 24
- S03AD Juego llaves impacto larga  
10; 11; 12; 13; 14; 16; 17; 19; 21; 22 y 24



**S04H2132KV**

127.00€

Tablero con 32 peças, llaves de vaso e extensiones (1/3 de cajón)

Composición:

- S09H3 Llaves de vaso punta hexagonal 1/2"
- S09H4 Llaves de vaso punta hexagonal 3/8"
- S49H4 Llave de vaso punta estriada 1/2"
- S24H4 Extensión 1/2" - 125 y 250mm
- S17H4 Llaves de bujía - 16 y 21mm
- S23H4125 Mango corredizo en "t"



**S04H4144KV**

145.00€

Tablero con 44 piezas, llaves de vaso con carraca (1/3 de cajón)

Composición:

- R3704 Carraca 1/2"
- R3702 Carraca 1/4"
- S04H4 Llaves de vaso 1/2"  
10; 11; 12; 13; 14; 15; 16; 17; 18; 19; 20; 21; 22; 23; 24;  
27; 30 y 32mm
- S04H2 Llaves de vaso 1/4"  
4; 5; 5,5; 6; 7; 8; 9; 10; 11; 12 y 13mm
- S04HD2 Llaves de vaso larga 1/4"  
5; 6; 7; 8; 9; 10; 11; 12 y 13mm
- S24H2 Prolongadores 1/4" - 50 y 150mm
- S26H2150 Mango 1/4"
- S15H472 Cardan 1/4"



## Tableros para herramienta

### Tableros en espuma de alta densidad EVA

**S29H4141KV**

69.00€

Tablero con 41 piezas, juego de puntas (1/3 de cajón)

Composición:

- Puntas 6 caras
- Puntas torx
- Puntas estriadas
- Soporte puntas de 1/2"
- Soporte punta de 3/8"
- Llave para clips de zapatas



**W25110KV**

62.00€

Tablero con 10 llaves de bocas (1/3 de cajón)

Composición:

- W25 6x7; 8x9; 10x11; 12x13; 14x15; 16x17; 18x19; 21x23; 24x27 y 30x32



**W26116KV**

72.00€

Tablero con 16 llaves mixtas - boca/ luneta (1/3 de cajón)

Composición:

- W26 6; 7; 8; 9; 10; 11; 12; 13; 14; 15; 16; 17; 18; 19; 20 y 22mm

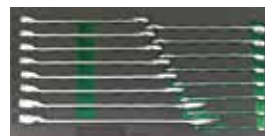

**AG10002SC**

54.00€

**Juego de machos y hembras**

Composición:

- Machos de roscar manuales M 3 a M12
- Terrajas M 3 a M12
- Porta terrajas
- Desandador de machos



**D376514SC**

39.50€

**Juego de llaves**

Composición:

- Juego de llaves de precisión
- Phillips: PH00; PH0 y PH1
- Plano: 2; 2,4 y 3mm
- Torx: T5; T6; T7; T8; T9; T10; T15 y T20



**P0813SC**

44.00€

**Juego de alicates**

Composición:

- P087** Alicate universal
- P097** Alicate de corte
- P118** Alicate de puntas



**R481 1SC**

63.00€

**Juego de llaves de vaso de 1/4" y 3/8"**

Composición/ medidas en mm:

- Trinquete de 1/4" de 72 dientes
- Trinquete de 3/8" de 72 dientes
- Extensor de 3/8": 75
- Extensor de 3/8": 250
- Extensor de 1/4": 50
- Extensor de 1/4": 150
- Cardán de 1/4"
- Cardán de 3/8"
- Adaptador 1/4" - 3/8"
- Adaptador 3/8" - 1/2"
- Mango



**S04H5129SC**

49.00€

**Juego de llaves de vaso 6 caras de 1/4 y 3/8" con 28 piezas**

Composición/ medidas en mm:

- Llaves de vaso de 1/4": 4; 4,4; 5; 5,5; 6; 7; 8; 9; 10; 11; 12 y 13
- Llaves de vaso largas: 8; 10; 12 y 13
- Llaves de vaso 3/8": 14; 15; 17; 18; 19; 20; 22 y 24
- Llaves de vaso largas: 14; 15 y 17
- Llaves de bujías 3/8": 16 y 21



**V11011SC**

39.50€

**Juego con remachadora de remaches con rosca**

Composición/ medidas en mm:

- Alicate remachadora
- Boquillas M3 a M6



**W25117SC**

59.50€

**Juego de llaves fijas y macho allen**

Composición/ medidas en mm:

- Llaves fijas: 8x9; 10x11; 12x13; 14x15; 16x17; 18x19; 20x22 y 24x27
- Llaves macho allen: 1,2; 2; 2,5; 3; 4; 5; 6; 8 y 10



**W27AT02SC**

49.00€

**Juego de alicates**

Composición/ medidas en mm:

- P32M10C** Alicata de presión
- W27AT10** Llave ajustable



**Tableros para herramienta vacios**

Tableros en espuma EVA aplicables en los carros: C4DWA1, C-6DWB1 y C-7DW1

**P-EVA(D7371234SV)**

29.60€

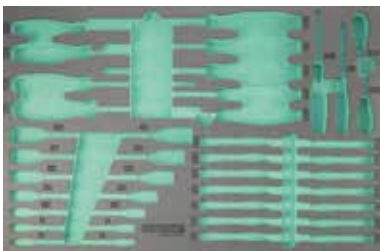

**P-EVA(D737128SV)**

29.60€



**P-EVA(H10121SV)**

29.60€



**P-EVA(P82714SV)**

29.60€



**P-EVA(P82736SV)**

29.60€



**P-EVA(S04H4295SV)**

29.60€

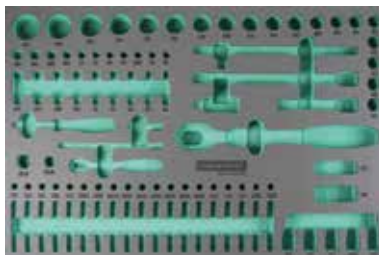

**P-EVA(S04H45121SV)**

29.60€

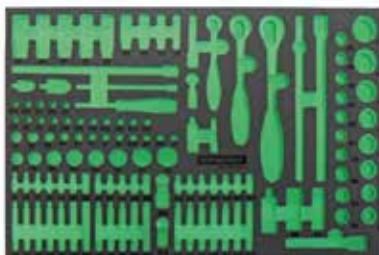

**P-EVA(W23559SV)**

29.60€



**P-EVA(W26134SV)**

29.60€

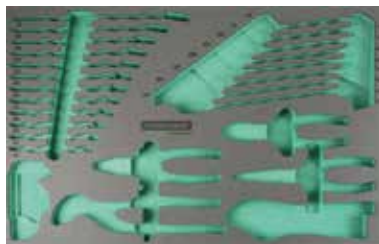

**P-EVA(W2623431SV)**

29.60€

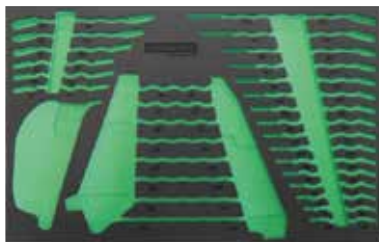



*Tableros en espuma EVA aplicables en los carros: C4DWA1, C-6DWB1 y C-7DW1*
**P-EVA(D71PP08KV)**

10.00€

**P-EVA(H10MB08KV)**

10.00€

**P-EVA(H10MT08KV)**

10.00€

**P-EVA(M09103KV)**

10.00€

**P-EVA(M63113KV)**

10.00€

**P-EVA(MHS08KV)**

19.00€

**P-EVA(P011804KV)**

10.00€

**P-EVA(P32M105KV)**

10.00€

**P-EVA(S03A4122KV)**

10.00€

**P-EVA(S04H2132KV)**

10.00€

**P-EVA(S04H4144KV)**

10.00€

**P-EVA(S29H4141KV)**

10.00€

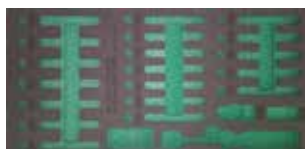
**P-EVA(W25110KV)**

10.00€

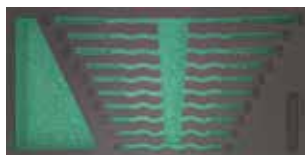
**P-EVA(W26116KV)**

10.00€

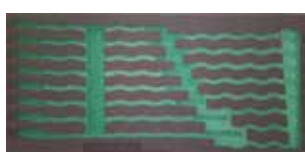

## Tableros para herramienta

### Cajas de plástico para tableros

**P-B (31)**

5.50€

Medidas:

425x185x52mm

**B**



**P-B (41)**

4.50€

Medidas:

375x144,5x52mm

**A**



## Tableros para herramienta vacios para composiciones

aplicable a los carros: C-4DW, C-6DW y C-7DW

P-TR(AG010002SP)	2.20€
P-TR(AG010026SP)	2.20€
P-TR(AI10002SP)	2.50€
P-TR(D70105SP)	2.20€
P-TR(D71PP08SP)	2.20€
P-TR(H10MB08SP)	2.50€
P-TR(M09513SP)	2.20€
P-TR(M645114SP)	2.50€
P-TR(P04704SP)	2.20€
P-TR(P0803SP)	2.20€
P-TR(P0903SP)	2.20€
P-TR(S03A4122SP)	2.20€
P-TR(S04H2125SP)	2.20€
P-TR(S04H3157SP)	2.70€
P-TR(S04H3536SP)	2.50€
P-TR(S04H4125SP)	2.70€
P-TR(S04H4524SP)	2.20€
P-TR(S04H4726SP)	2.50€
P-TR(S04H4728SP)	2.50€
P-TR(S06H427SP)	2.20€
P-TR(S09H4118SP)	2.20€
P-TR(S29H4140SP)	2.70€
P-TR(W23108SP)	2.20€
P-TR(W25110SP)	2.20€
P-TR(W26112SP)	2.20€
P-TR(W26116SP)	2.50€



## Tableros para herramienta vacios para composiciones

aplicable a la maleta: C-3DH2

**P-TR (D70SP06ST)**

1.50€

Para llaves D70



**P-TR (PC303ST)**

1.50€

Para alicates: P087; P106 y P118



**P-TR (S04H4120ST)**

1.50€

Para llaves de vaso de 1/2" con trinquete



**P-TR (S04H4506ST)**

1.50€

Para extensores



**P-TR (W26107ST)**

1.50€

Para llaves mixtas W26



**P-TR (W26920ST)**

1.50€

Para para llaves mixtas W26 y llaves de 6 caras



**T21**

Llave dinamométrica con precisión de: +/- 3%

Ref.	Boquilla	Capacidad (Nm)	Longitud (mm)	Precio
T21025N	1/4"	5-25	320	96.50€
T21050N	3/8"	10-50	390	102.00€
T211000N	1"	200-1 000	1 510	530.00€
T21101N	1/2"	20-100	390	108.00€
T21200N	1/2"	40-200	502	110.00€
T21340N	1/2"	60-340	604	135.00€
T21341N	3/4"	60-340	604	145.00€
T21550N	3/4"	110-550	938	335.00€

**T25**

Llave dinamométrica con precisión de: +/- 4%

Ref.	Boquilla	Capacidad (Nm)	Longitud (mm)	Precio
T25100N	3/8"	20-100	390	85.00€
T25200N	1/2"	40-200	502	90.00€
T25340N	1/2"	60-340	604	110.00€

**T27**

Llave dinamométrica con precisión de: +/- 4%

Ref.	Boquilla	Capacidad (Nm)	Longitud (mm)	Precio
T27010N	1/4"	4-10	308	60.00€
T27020N	1/4"	4-20	340	58.50€
T27021N	3/8"	4-20	340	58.50€
T27060N	3/8"	10-60	340	64.00€
T271001N	1"	200-1 000	1 177	440.00€
T27101N	1/2"	20-100	458	70.00€
T27200N	1/2"	40-200	531	76.00€
T27340N	1/2"	60-340	585	84.00€
T27800N	3/4"	150-800	1 177	360.00€

**T30200NS**

230.00€

Barra dinamométrica con conjunto de 9 puntas de bocas -

Precisión: 4%

Composición:

Capacidad: 40-200 Nm

Trinquete reversible de 1/2"

Encaixe: 14x18mm

Puntas de bocas de: 12; 14; 15; 17; 19; 22; 24; 27 y 30mm

**T10H1210S**

302.00€

Juego de llave dinamométrica con 7 llaves intercambiables 14x18

Capacidad: 40-210 Nm

**T103**

Llave "Pie de Gallo" 14x18

Ref.	Medida (mm)	Precio
T10313	13	10.00€
T10314	14	10.00€
T10315	15	10.00€
T10316	16	10.00€
T10317	17	10.00€
T10318	18	10.00€
T10319	19	10.00€
T10321	21	10.00€
T10322	22	10.00€
T10324	24	10.60€

**T29014**

16.50€

Cabezal para llave dinamométrica de cabezas intercambiables

Boquilla: 1/2"

14/18mm

**T14100N**

240.00€

Llave dinamométrica digital intercambiable con precisión de: +/- 1%

Capacidad: 10-100Nm

Longitud: 420mm

Peso: 840g

Cabeza: 14x18

Memoria: 10 lecturas

Unidad: Nm; fb-lb; Kg-m; in-lb

Baterías: 3x1,5v AA (no incluidas)



**T14200N**

250.00€

Llave dinamométrica digital intercambiable con precisión de: +/- 1%

Capacidad: 20-200Nm Memoria: 10 lecturas  
 Longitud: 550mm Unidad: Nm; fb-lb; Kg-m; in-lb  
 Peso: 1 150g Baterías: 3x1,5v AA (no incluidas)  
 Cabeza: 14x18



**T154100N**

230.00€

Llave dinamométrica digital con precisión de: +/- 1%

Capacidad: 10-100Nm Memoria: 10 lecturas  
 Longitud: 440mm Unidad: Nm; fb-lb; Kg-m; in-lb  
 Peso: 1 060g Baterías: 3x1,5v AA (no incluidas)  
 Cabeza: 14x18 Boquilla: 1/2"



**T154200N**

250.00€

Llave dinamométrica digital con precisión de: +/- 1%

Capacidad: 20-200Nm Memoria: 10 lecturas  
 Longitud: 580mm Unidad: Nm; fb-lb; Kg-m; in-lb  
 Peso: 1 350g Baterías: 3x1,5v AA (no incluidas)  
 Cabeza: 14x18 Boquilla: 1/2"



**T19**

Medidor digital de torque con precisión de: +/- 2%

Advertencia de luz y sonido

Ref.	Boquilla	Torque (Nm)	Precio
T19135N	3/8"	10-135	63.00€
T19200N	1/2"	20-200	64.50€



**T**

Kits de reparación para llaves dinamométricas

Ref.	Aplicable a los modelos	Precio
T04M060-R	T04M060	6.80€
T04M061-R	T04M061	6.80€
T04M150-R	T04M150	8.30€
T04M250-R	T04M250	11.00€
T07030N-R	T07030N	6.60€
T07110N-R	T07110N	7.20€
T07350N-R	T07350N	11.20€
T07700N-R	T07700N	48.50€
T102001S-R	T102001S	11.60€
T154100N-R	T154100N	9.00€
T154200N-R	T154200N	13.80€
T16005N-R	T16005N	8.00€
T21025N-R	T21025N	8.70€
T21050N-R	T21050N	10.00€
T211000N-R	T211000N	56.50€
T21101N-R	T21101N	12.00€
T21200N-R	T21200N	12.00€
T21340N-R	T21340N	11.00€
T21341N-R	T21341N	40.00€
T21550N-R	T21550N	40.00€
T25100N-R	T25100N	10.00€
T25200N-R	T25200N	11.20€
T25340N-R	T25340N	11.20€
T27-D2R	T27010N, T27020N, T27030N	6.00€
T27-D3R	T27021N, T27031N, T27060N, T27100N	6.50€
T27-D4R1	T27101N	7.00€
T27-D4R2	T27200N, T27340N	7.50€
T27-D6R	T27500N, T27600N, T27800N, T271000N	19.00€
T27-D8R	T27801N, T271001N	31.00€

**R12**



Trinquete reversible de 12 dientes

Ref.	Boquilla	Longitud (mm)	Precio
R1206	3/4"	500	54.80€
R12081	1"	675	124.00€

**R29**



Trinquete reversible de 36 dientes

Ref.	Boquilla	Longitud (mm)	Precio
R2902	1/4"	146	11.30€
R2904	1/2"	278	17.00€

**R34**

**Trinquete de 72 dientes con mango antideslizante**

Ref.	Boquilla	Longitud (mm)	Torque (Nm)	Precio
<b>R3403</b>	3/8"	196	245	<b>19.00€</b>

**R35**

**Trinquete de 72 dientes con mango antideslizante**

Ref.	Boquilla	Comp. (mm)	Torque (Nm)	Precio
<b>R3502</b>	1/4"	135	68	<b>12.80€</b>
<b>R3503</b>	3/8"	199	245	<b>15.00€</b>
<b>R3504</b>	1/2"	250	647	<b>19.20€</b>

**R36**

**Trinquete de metal reversible de 48 dientes**

Ref.	Boquilla	Longitud (mm)	Torque (Nm)	Precio
<b>R3602</b>	1/4"	128	68	<b>12.50€</b>
<b>R3603</b>	3/8"	198	245	<b>15.00€</b>

**R37**
**Trinquete reversible de 48 dientes con puño antideslizante**

Ref.	Boquilla	Longitud (mm)	Torque (Nm)	Precio
<b>R3702</b>	1/4"	135	68	<b>12.70€</b>
<b>R3703</b>	3/8"	198	245	<b>15.90€</b>
<b>R3704</b>	1/2"	353	647	<b>18.70€</b>

**R37B**

**Trinquete reversible corto de 48 dientes con puño antideslizante**

Ref.	Boquilla	Longitud (mm)	Torque (Nm)	Precio
<b>R3702B</b>	1/4"	110	68	<b>12.20€</b>
<b>R3704B</b>	1/2"	180	647	<b>17.50€</b>

**R41**

**Trinquete reversible y articulado de 36 dientes con puño antideslizante**

Ref.	Boquilla	Longitud (mm)	Precio
<b>R4103</b>	3/8"	238	<b>17.40€</b>
<b>R4104</b>	1/2"	288	<b>22.20€</b>

**R45**

**Trinquete reversible y rotativo de 48 dientes**

Ref.	Boquilla	Longitud (mm)	Precio
<b>R4502</b>	1/4"	185	<b>27.70€</b>

**R48**

**Trinquete reversible de metal de 72 dientes**

Ref.	Boquilla	Longitud (mm)	Precio
<b>R4802A</b>	1/4"	125	<b>10.80€</b>
<b>R4804A</b>	1/2"	250	<b>17.00€</b>

**R51**

**Trinquete reversible y extensible de 72 dientes con puño antideslizante**

Ref.	Boquilla	Longitud (mm)	Precio
<b>R5104</b>	1/2"		<b>22.50€</b>

**R66**
**Trinquete de cable giratorio de 60 dientes**

Ref.	Boquilla	Longitud (mm)	Peso (g)	Precio
<b>R6602</b>	1/4"	180	181	<b>33.50€</b>
<b>R6603</b>	3/8"	290	645	<b>35.50€</b>
<b>R6604</b>	1/2"	240	384	<b>42.00€</b>

**T094602**
**290.00€**
**Trinquete desmultiplicador 1/2" - 3/4" R 1:9**

Torque máximo: 1 500 Nm

**T094602-RK**
**220.00€**

Kit de reparación

**T096801** 310.00€

Trinquete desmultiplicador 3/4" - 1" R 1:4  
Torque máximo: 2 500 Nm



**T096801-RK** 210.00€

Kit de reparación

**T10148** 85.00€

Atornillador de apriete con juego de puntas

Boquilla	Torque (Nm)
1/4"	1-8



**R**

Kits de reparación para trinquetes

Ref.	Aplicable a los modelos	Precio
R1206R	R1206R	17.90€
R2902RK	R2902; R2902A; R2902B	5.20€
R2903RK	R2903; R2903A; R2903B ; R4103	5.80€
R2904RK	R2904; R2904A; R2904B ; R4104	6.60€
R3602RK	R3602; R3702; R3702B; R3802	6.70€
R3603RK	R3603; R3703; R3803	8.60€
R3604RK	R3604; R3704; R3704B; R3804	9.20€
R3402RK	R3402; R3502	6.70€
R3403RK	R3403; R3503	8.30€
R3404RK	R3404; R3504	9.70€
R4502RK	Para cabeça de roquete	6.50€
R4502JRK	Para articulação	6.50€
R4802RK	R4802	5.20€
R4804RK	R4804	6.20€
R5104RK	R5104	7.50€
R5802ERK	R5802E	9.30€
R5803RK	R5803	11.40€
R5804ERK	R5804E	14.60€
R5804LRK	R5804L	14.60€
R12081RK	R12081	56.20€

**W24A107S** 83.00€

Juego 7 llaves fijas abiertas flexibles

Composición:

Llaves: 8x8; 10x10; 11x11; 12x12; 13x13; 14x14 y 17x17



**W45**



Llave combinada fija/ trinquete

Ref.	Medida (mm)	Longitud (mm)	Precio
W45108	8	135,40	7.40€
W45109	9	159,50	7.60€
W45110	10	159,50	7.60€
W45111	11	165,90	7.90€
W45112	12	168,60	8.00€
W45113	13	178,50	8.40€
W45114	14	190,50	8.90€
W45115	15	199,40	10.00€
W45116	16	206,40	10.40€
W45117	17	225,40	11.00€
W45118	18	236,40	12.50€
W45119	19	247,40	12.50€
W45121	21	281,00	19.50€
W45124	24	311,00	22.00€

**W45110S** 82.00€

Juego de llaves de boca/ trinquete de 9 piezas

Composición:

W45 Llaves: 8; 10; 12; 13; 17 y 19mm  
Adaptadores 1/4"; 3/8" y 1/2"



**W45117S** 320.00€

Juego de llaves combinadas fija/ trinquete con 72 dientes de 17 piezas

Composición:

W45 Llaves: 8; 10; 12; 13; 14; 17; 19; 21; 22; 24; 27; 30 y 32mm  
Adaptadores 1/4"; 3/8"; 1/2" y 3/4"  
Maleta



**W45316S**
**128.00€**
**Juego de llaves combinadas fija/ trinquete con 72 dientes de 16 piezas**

Composición:

**W45** Llaves: 8 a 19mm  
 Adaptadores 1/4"; 3/8" y 1/2"  
 Soporte de puntas  
 Maleta

**W45316S-AD**
**13.50€**
**Conjunto de 4 adaptadores**

Composición:

 Adaptadores 1/4"; 3/8" y 1/2"  
 Soporte de puntas

**W51110S**
**105.00€**
**Juego de 10 llaves cortas fija/ trinquete**

Composición:

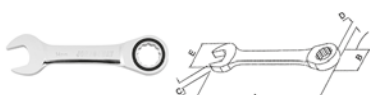
**W51** Llaves: 8; 10; 11; 12; 13; 14; 15; 16; 17 y 19mm

**W52105S**
**70.00€**
**Juego de 5 llaves cortas fija/ trinquete flexible**

Composición:

**W52** Llaves: 8; 10; 12; 14 y 17mm

**W66**
**Llave fija/ trinquete flexible**

Ref.	Medida (mm)	Longitud (mm)	Precio
<b>W66108</b>	8	137	12.90€
<b>W66109</b>	9	159	13.00€
<b>W66110</b>	10	159	13.00€
<b>W66111</b>	11	175	13.90€
<b>W66112</b>	12	175	14.70€
<b>W66113</b>	13	186	14.70€
<b>W66114</b>	14	194	15.60€
<b>W66115</b>	15	216	16.30€
<b>W66116</b>	16	216	17.60€
<b>W66117</b>	17	232	17.60€
<b>W66118</b>	18	250	18.60€
<b>W66119</b>	19	250	19.20€

**W66107S**
**104.00€**
**Juego de 7 llaves fija/ trinquete flexible**

Composición:

**W66** Llaves: 8; 10; 11; 13; 14; 17 y 19mm

**W66116S**
**193.00€**
**Juego de llaves combinadas fija/ trinquete flexible de 72 dientes con 16 piezas**

Composición:

**W66** Llaves: 8 a 19mm  
 Adaptadores 1/4"; 3/8" y 1/2"  
 Soporte de puntas  
 Maleta

**W67104S**
**53.00€**
**Juego de llaves estrella (torx) con trinquete**

Composición:

 Llaves: E6xE8; E10xE12;  
 E14xE18 y E20xE24mm

**W68**

Llave trinquete de 72 dientes



Ref.	Medida (mm)	Precio
W680809	8x9	12.20€
W680810	8x10	12.20€
W681011	10x11	12.40€
W681213	12x13	12.70€
W681415	14x15	15.00€
W681618	16x18	16.00€
W681719	17x19	18.00€

**W68106S**

81.00€

Juego de llaves trinquete de 72 dientes con 6 piezas

Composición:

W68 Llaves: 8x9; 10x11; 12x13; 14x15; 16x18 y 17x19



**W73102S**

40.00€

Juego de llaves con trinquete 4 en 1

Se puede utilizar en 4 medidas

Composición/ medidas en mm:

Llave 8x10 - 12x13  
Llave 14x17 - 18x19



**W91107S**

78.50€

Juego de llaves combinadas fija especial/ trinquete de 72 dientes

Composición:

Llaves: 10; 12; 13; 14; 15; 17 y 19mm

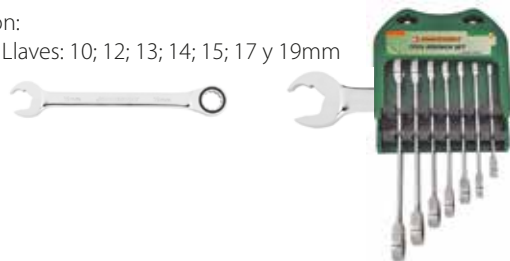

**W93108S**

104.00€

Juego de llaves mixtas con trinquete reversible y anillo de retención

Composición:

Llaves: 10; 11; 12; 13; 14; 15; 17 y 19mm



**W93**

Llave Mixta Boca Trinquete con anillo retención



Ref.	Medida (mm)	Longitud (mm)	Precio
W93110	10	158	11.50€
W93111	11	164	12.00€
W93112	12	167	13.00€
W93113	13	177	13.50€
W93114	14	189,4	14.00€
W93115	15	198	15.00€
W93117	17	224	17.30€
W93119	19	245	19.50€

**W61**

Llave de estrella larga



Ref.	Medida (mm)	Longitud (mm)	Precio
W611011	10x11	295	9.50€
W611214	12x14	330	11.00€
W611315	13x15	370	13.00€
W611618	16x18	405	14.50€
W611719	17x19	405	15.00€
W612224	22x24	435	21.50€

**W61106S**

85.50€

Juego de 6 llaves estrella largas

Se suministra en una bolsa de plástico con divisiones

Composición:

Medida	Longitud (mm)
10x11	235
12x14	330
13x15	370
16x18	405
17x19	405
22x24	435



**W62**

Llave de estrella derecha



Ref.	Medida (mm)	Longitud (mm)	Precio
W6210607	6x7	120	3.50€
W6210809	8x9	135	3.80€
W6211011	10x11	150	4.00€
W6211213	12x13	165	4.50€
W6211415	14x15	210	5.00€
W6211617	16x17	210	5.80€
W6211819	18x19	225	6.00€
W6212022	20x22	240	7.00€
W6212427	24x27	270	11.50€
W6212528	25x28	285	12.50€
W6213032	30x32	335	14.50€



**W62108S**
**43.00€**
**Juego de 8 llaves estrella derecha**

Composición:

**W62** Llaves: 6x7; 8x9; 10x11; 12x13;  
14x15; 16x17; 18x19 y 20x22mm

**W23**
**Llave de estrella acodada 75°**

Ref.	Medida (mm)	Precio
W230607	6x7	3.40€
W230809	8x9	3.50€
W231011	10x11	4.20€
W231213	12x13	4.60€
W231415	14x15	5.20€
W231617	16x17	5.70€
W231819	18x19	6.60€
W232022	20x22	7.80€
W232123	21x23	9.20€
W232426	24x26	10.30€
W232427	24x27	10.30€
W232528	25x28	11.00€
W233032	30x32	12.70€

**W23108S**
**48.50€**
**Juego de 8 llaves de estrella acodada 75°**

Se suministra en una bolsa de plástico con divisiones

Composición:

**W23** Llaves: 6x7; 8x9; 10x11; 12x13;  
14x15; 16x17; 18x19 y 20x22mm

**W24**
**Llave de estrella abierta**

Ref.	Medida (mm)	Precio
W240809	8x9	2.80€
W241011	10x11	3.00€
W241012	10x12	3.00€
W241314	13x14	3.50€
W241417	14x17	4.60€
W241617	16x17	5.00€
W241719	17x19	5.40€
W241819	18x19	6.00€
W241922	19x22	7.00€
W242528	25x28	11.10€
W243032	30x32	12.00€

**W24106S**
**30.00€**
**Juego de 6 llaves de estrella abierta**

Se suministra en una bolsa de plástico con divisiones

Composición:

**W24** Llaves: 8x9; 10x11; 10x12;  
13x14; 16x17 y 17x19mm

**W24N**
**Llave de estrella abierta con tapa**

Ref.	Medida (mm)	Longitud (mm)	Precio
W24N0810	8x10	122	6.40€
W24N1113	11x13	143	7.50€
W24N1214	12x14	145	7.60€
W24N1719	17x19	162	10.70€

**W25**
**Llave fijas**

Ref.	Medida (mm)	Precio
W250607	6x7	1.90€
W250809	8x9	2.10€
W251011	10x11	2.30€
W251213	12x13	2.70€
W251415	14x15	3.10€
W251417	14x17	3.50€
W251617	16x17	3.60€
W251819	18x19	4.10€
W242022	20x22	5.00€
W252123	21x23	5.60€
W252426	24x26	6.70€
W252427	24x27	6.70€
W252528	25x28	8.00€
W252730	27x30	9.50€
W252732	27x32	9.80€
W253032	30x32	9.80€
W253236	32x36	17.40€
W253641	36x41	24.00€
W254146	41x46	36.00€
W254650	46x50	49.00€

**W25108S**
**32.00€**
**Juego de 8 llaves fijas**

Se suministra en una bolsa de plástico con divisiones

Composición:

**W25** Llaves: 6x7; 8x9; 10x11; 12x13;  
14x15; 16x17; 18x19 y 20x22mm

**W39**

Llave de bocas de perfil fino



Ref.	Medida (mm)	Longitud (mm)	Precio
W391011	10x11	175	4.50€
W391213	12x13	210	5.20€
W391415	14x15	210	5.30€
W391617	16x17	250	7.70€
W391819	18x19	250	7.80€

**W26**

Llave combinada fija/ estrella



Ref.	Medida (mm)	Precio
W26106	6	1.80€
W26107	7	1.90€
W26108	8	1.90€
W26109	9	2.00€
W26110	10	2.10€
W26111	11	2.20€
W26112	12	2.40€
W26113	13	2.60€
W26114	14	2.80€
W26115	15	3.10€
W26116	16	3.20€
W26117	17	3.70€
W26118	18	4.10€
W26119	19	4.50€
W26120	20	4.90€
W26121	21	5.40€
W26122	22	5.50€
W26123	23	6.10€
W26124	24	6.30€
W26125	25	6.90€
W26126	26	7.40€
W26127	27	7.90€
W26128	28	8.30€
W26129	29	9.20€
W26130	30	9.70€
W26132	32	10.60€
W26134	34	19.00€
W26136	36	22.80€
W26138	38	29.20€
W26141	41	33.70€
W26142	42	34.00€
W26144	44	44.00€
W26146	46	45.00€
W26148	48	60.50€
W26150	50	61.00€
W26155	55	102.00€
W26160	60	133.00€
W26165	65	175.00€

**W26**

Juego de llaves combinadas fija/ estrella

Se suministra en una bolsa de plástico con divisiones

Ref.	Llaves	Medida (mm)	Precio
W26112S	12xW26	8 a 17; 19 y 22	45.50€
W26114S	14xW26	10 a 14; 16; 17; 19; 21; 22; 24; 27; 30 y 32	81.00€
W26126S	12xW26	6 a 32	145.00€



**W26411PRS**

52.50€

Juego de 11 llaves mixtas largas

Se suministra en una bolsa de plástico con divisiones

Composición:

W264 Llaves: 7; 8; 9; 10; 11; 12; 13; 14; 15; 17 y 19mm



**W26414S**

122.00€

Juego de 14 llaves mixtas fija/ estrella SAE

Se suministra en una bolsa de plástico con divisiones

Composición:

Ref.	Medida	Ref.	Medida
W26410	3/8"	W26421	13/16"
W26411	7/16"	W26422	7/8"
W26413	1/2"	W26424	15/16"
W26414	9/16"	W26425	1"
W26416	5/8"	W26427	1-1/16"
W26417	11/16"	W26430	1-1/8"
W26419	3/4"	W26432	1-1/4"



**W69116S**
**117.00€**
**Juego de 16 llaves mixtas 75°**

Composición:

**W69** Llaves: 7; 8; 9; 10; 11; 12; 13; 14; 15; 16; 17; 18; 19; 21; 22 y 24mm

**W29**
**Llave estrella para tornillos torx**

Ref.	Medida	Longitud (mm)	Precio
<b>W290608</b>	E6xE8	112	5.20€
<b>W290711</b>	E7xE11	125	5.90€
<b>W291012</b>	E10xE12	140	6.00€
<b>W291418</b>	E14xE18	180	6.00€
<b>W291622</b>	E16xE22	200	6.60€
<b>W292024</b>	E20xE24	224	6.60€

**S57**
**Llaves de pipa**

Ref.	Medida (mm)	Precio
<b>S57H108</b>	8	6.80€
<b>S57H110</b>	10	7.80€
<b>S57H111</b>	11	8.10€
<b>S57H113</b>	13	12.10€
<b>S57H115</b>	15	12.10€
<b>S57H116</b>	16	12.90€
<b>S57H117</b>	17	14.70€
<b>S57H118</b>	18	14.70€
<b>S57H119</b>	19	15.30€
<b>S57H121</b>	21	20.90€
<b>S57H123</b>	23	26.30€
<b>S57H125</b>	25	33.00€
<b>S57H127</b>	27	38.00€
<b>S57H132</b>	32	56.50€

**S57H108S**
**95.00€**
**Juego de 8 llaves de pipa**

Se suministra en una bolsa de plástico con divisiones

Composición:

**S57** Llaves: 8; 10; 11; 13; 16; 17; 18 y 19mm

**W65**
**Llave de estrella curvada para motores de arranque**

Ref.	Medida (mm)	Precio
<b>W6510810</b>	8x10	3.10€
<b>W6511012</b>	10x12	3.60€
<b>W6511315</b>	13x15	4.00€
<b>W6511417</b>	14x17	4.90€
<b>W6511922</b>	19x22	6.10€

**W65A105S**
**52.00€**
**Juego de 5 llaves estrella curvadas**

Composición:

**W65A** Llaves: 10x12; 12x14; 13x15; 16x18 y 17x19mm

**W43A**
**Llave de vaso flexible**

Ref.	Medida (mm)	Longitud (mm)	Precio
<b>W43A0607</b>	6x7	180	5.00€
<b>W43A0809</b>	8x9	180	5.00€
<b>W43A1011</b>	10x11	202	5.40€
<b>W43A1213</b>	12x13	222	6.40€
<b>W43A1415</b>	14x15	245	7.40€
<b>W43A1617</b>	16x17	260	8.40€
<b>W43A1819</b>	18x19	280	9.80€

**W43A106S**
**45.50€**
**Juego de 6 llaves de vaso flexible**

Composición:

**W43A** Llaves: 8x9; 10x11; 12x13; 14x15; 16x17 y 18x19mm  
Maleta

**W77A**



**Llave de estrella 70° para extensión**

Utilice extensor de serie W77A

Ref.	Medida (mm)	Longitud (mm)	Precio
W77A124	24	180	17.50€
W77A127	27	190	20.30€
W77A130	30	200	23.50€
W77A132	32	235	27.50€
W77A136	36	245	33.00€
W77A138	38	245	34.00€
W77A141	41	265	39.50€
W77A146	46	280	46.00€
W77A150	50	290	49.00€
W77A155	55	300	72.00€
W77A160	60	345	95.00€
W77A165	65	355	115.00€



**W77H**



**Extensor para llave W77A**

Utilizable en conjunto con las llaves de serie W77A

Ref.	Medida (mm)	Utilizar en (mm)	Precio
W77H01	480	24~30	22.00€
W77H02	610	32~41	34.00€
W77H03	760	46~55	59.00€
W77H04	860	60~65	75.00€

**WFS46**

29.00€

**Llave para filtro del diferencial**

Incluye llave hexagonal de 5mm

Medida: 46mm

Estriado de 12 caras

Aplicación: VW: Bora, Golf IV, Sharan

Skoda: Octavia



**W67**

**Llave de boca para golpes**



Ref.	Medida (mm)	Longitud (mm)	Precio
W67119	19	177	5.10€
W67121	21	177	5.20€
W67124	24	197	6.30€
W67130	30	243	10.00€

**W72**



**Llave de estrella gran potencia**

Ref.	Medida (mm)	Longitud (mm)	Precio
W72122	22	163	9.00€
W72124	24	163	9.00€
W72127	27	180	9.00€
W72130	30	190	13.00€
W72132	32	190	13.00€
W72134	34	205	18.00€
W72136	36	205	19.00€
W72141	41	230	23.00€
W72146	46	240	30.00€
W72150	50	255	40.00€
W72170	70	335	125.00€

**W27AT**



**Llave ajustable con mango antideslizante**

Ref.	Medida (mm)	Longitud (mm)	Precio
W27AT8	24	200	17.50€
W27AT10	29	250	21.90€
W27AT12	34	300	26.50€
W27AT15	43	375	52.00€



**W27AS**



**Llave inglesa**

Ref.	Apertura (mm)	Longitud (mm)	Precio
W27AS8	20	150	12.50€
W27AS10	29	250	15.50€
W27AS15	43	380	42.00€
W27AS18	53	450	67.00€

**W27AR**



**Llave inglesa**

Ref.	Apertura (mm)	Longitud (mm)	Precio
W27AR8	26,9	200	24.00€
W27AR10	34	250	30.00€



ON: actúa como de trinquete

OFF: actúa como llave inglesa



**W27AK8**

27.00€

Llave inglesa sistema dual (métrico/SAE)

Longitud: 200mm

**W28HD**

Llave tubos pico de halcón

Ref.	Apertura (mm)	Longitud (mm)	Precio
W28HD8	10-22	200	29.20€
W28HD10	12-30	250	33.00€
W28HD12	16-36	300	39.20€
W28HD14	18-50	350	44.50€

**W28**

Llave para tubos

Ref.	Apertura (mm)	Longitud (mm)	Precio
W2808	25,5	200	14.50€
W2810	38	250	15.20€
W2812	51	300	21.00€
W2814	51	350	24.00€
W2818	63,5	450	38.00€
W2824	76	600	60.50€
W2836	127	900	135.00€

**W28RJ-HL**

Garras de repuesto

Ref.	Aplicable modelo	Precio
W2810RJ-HL	W2810	5.30€
W2812RJ-HL	W2812	6.40€
W2814RJ-HL	W2814	7.00€
W2818RJ-HL	W2818	9.40€
W2824RJ-HL	W2824	13.80€
W2836RJ-HL	W2836	26.20€

**Herramienta manual**
**Herramienta SUPERTECH**

**S68H2141S**

47.50€

Juego de 41 piezas de 1/4" SUPERTECH

Composición/ medidas en mm:

- R2902 Trinquete de 36 dientes  
 Llaves de vaso: 4; 4,5; 5; 5,5; 6; 7; 8; 9; 10; 11; 12; 13 y 14  
 Llaves hexagonales: 1,5; 2 y 2,5  
 20 Puntas  
 Extensor de 50  
 Cable en "T" corridizo  
 Adaptador hexagonal  
 Mango

**S68H4127S**

114.00€

Juego de 27 piezas de 1/2" SUPERTECH

Composición/ medidas en mm:

- R2904 Trinquete de 36 dientes  
 Llaves de vaso: 8 a 24; 27; 30 y 32  
 Vasos de bujias: 16 y 21  
 Cardán  
 Extensor de 125 y 250  
 Cable en "T" corridizo



**S68H5234111S**

299.00€

**Juego de 111 piezas de 1/4", 3/8" y 1/2" SUPERTECH**

Composición/ medidas en mm:

- R3702 Trinquete de 1/4"
- R3703 Trinquete de 3/8"
- R3704 Trinquete de 1/2"
- Llaves de vaso de 1/4": 3,2 a 13
- Llaves de vaso de 3/8": 9 a 19
- Llaves de vaso de 1/2": 14 a 32
- Vasos de bujias de 3/8": 14 y 18
- Vasos de bujias de 1/2": 16 y 21
- Llaves hexagonales: 1,5; 2 y 2,5
- Llaves mixtas fija/ estrella: 8 a 19
- Puntas de 1/4" plano/ phillips/ torx/ hexagonal/pozi
- Puntas de 5/16" plano/ phillips/ torx/ hexagonal/pozi
- Adaptador bits 5/16"
- Cardán de 1/4"; 3/8" y 1/2"
- Extensores de 1/4" con 50 y 150
- Extensores de 3/8" con 75 y 150
- Extensores de 1/2" con 125 y 250
- Adaptador en "T" para extensiones
- Mango

**S68H**
**Llave de vaso 1/4" SUPERTECH**

Ref.	Métrica (mm)	SAE	Torque	Precio
S68H2103	3	1/8"	E4	0.70€
S68H2104	4	5/32"	E5	0.70€
S68H21045	4,5			0.70€
S68H2105	5	3/16"	E6	0.70€
S68H21055	5,5	7/32"	E7	0.75€
S68H2106	6		E8	0.75€
S68H21065	6,5	1/4"	E8	0.75€
S68H2107	7	9/32"		0.75€
S68H2108	8	5/16"	E10	0.80€
S68H2109	9	11/32"	E11	0.80€
S68H2110	10	3/8"	E12	0.80€
S68H2111	11	7/16"	E14	0.80€
S68H2112	12	15/32"		0.90€
S68H2113	13	1/2"	E16	0.90€
S68H2114	14	9/16"	E18	1.10€

**W84108S**

57.00€

**Juego de 8 llaves combinada fija/ estrella SUPERTECH**

Llaves: 8; 10; 11; 12; 13; 14; 17 y 19mm

**W84114S**

81.00€

**Juego de 14 llaves combinada fija/ estrella SUPERTECH**

Llaves: 6 a 19mm

**W84**
**Llaves combinada fija/ estrella SUPERTECH**

Ref.	Medida (mm)	Precio
W84106	6	3.80€
W84107	7	3.90€
W84108	8	4.00€
W84109	9	4.20€
W84110	10	4.50€
W84111	11	4.70€
W84112	12	5.00€
W84113	13	5.50€
W84114	14	5.70€
W84115	15	56.50€
W84116	16	7.00€
W84117	17	7.50€
W84118	18	8.00€
W84119	19	9.00€

**W86112S**

189.00€

**Juego de 12 llaves combinada fija/ trinquete SUPERTECH**

Llaves: 8 a 19mm



**S03H2327S**

59.00€

Juego de llaves y puntas de vaso de 1/4" con 27 piezas

Composición/ medidas en mm:

- Llave combinada fija/trinquete
- Mini llaves 13mm: 4; 4,5; 5; 5,5; 6; 7; 8; 9; 10; 11; 12; 13 y 14
- Puntas de vaso hexagonales: 3; 4; 5 y 6mm
- Puntas de vaso phillips: PH1; Ph2 y Ph3
- Puntas de vaso plana: 5,5 y 7mm
- Cardán
- Extensor 50mm
- Cable en "T" corredizo 115mm



**S04H2118S**

31.60€

Juego de llaves de vaso de 1/4" con 18 piezas

Composición/ medidas en mm:

- R2902 Trinquete de 36 dientes
- S04H2 Llaves de vaso: 4; 4,5; 5; 5,5; 6; 7; 8; 9; 10; 11; 12 y 13
- S24H2 Extensores de 2" y 4"
- S23H2 Cable en "T" corredizo
- S15H240 Adaptador universal
- S22H2130 Mango flexible



**S04H2141S**

62.50€

Juego de llaves de vaso de 1/4" con 41 piezas

Composición/ medidas en mm:

- R3702 Trinquete de 48 dientes
- S04H2 Llaves de vaso: 4; 5; 5,5; 6; 7; 8; 10; 11; 12 y 13
- S04HD2 Llaves de vaso largas: 7; 8 y 10
- Llaves macho hexagonales: 1,5; 2; 2,5 y 3
- S09H2 Puntas hexagonales: 3; 4; 5 y 6
- S07H2 Puntas torx: T10; T20; T25; T27; T30 y T40
- S10H2 Puntas planas: 0,8x4; 1,0x5,5 y 1,2x7
- S11H2 Puntas phillips: PH1; PH2 y PH3
- S24H Extensores de 2" y 6"
- S28H1 Puño
- S15H240 Adaptador universal
- S27H2150 Extensor flexible 6"
- S16H3814 Adaptador 3/8 (F) x 1/4" (M)
- Caja en metal



**S04H3125S**

65.00€

Juego de llaves de vaso de 3/8" con 25 piezas

Composición/ medidas en mm:

- R3703 Trinquete de 48 dientes
- Vaso de bujias: 6 a 22
- Llaves de velas: 16 y 21
- S24H Extensores de 75 y 150
- S23H31200 Cable en "T" corredizo de 200
- S15H356 Cardán
- Caja en metal



**S04H3141S**

109.00€

Juego de llaves de vaso de 3/8" con 40 piezas

Composición/ medidas en mm:

- R3703 Trinquete de 48 dientes
- S04H3 Llaves de vaso: 6 a 24
- Llaves de vaso largas: 14; 15; 17 y 19
- Puntas torx: T10; T20; T25; T27; T30; T40; T45 y T50
- Puntas planas: 0,8x4; 1x5,5 y 1,2x8
- Puntas phillips: PH1; PH2 y PH3
- 2 Extensores
- Cardán
- Adaptador universal
- Maleta de transporte



**S04H3536S**

93.00€

Juego de llaves de vaso de 3/8" con 36 piezas

Composición/ medidas en mm:

- R3503 Trinquete de 72 dientes
- Llaves de vaso: 6 a 22mm
- Llaves mixtas: 7 a 17mm
- Vaso de bujias: 16 y 21mm
- Extensiones de 75; 150 y 225mm
- Cardán
- S16H403 Adaptador
- Caja en metal



**S04H3157S**

120.00€

**Juego de llaves de vaso de 1/4" y 3/8" con 56 piezas**

Composición/ medidas en mm:

- R3702 Trinquete 1/4" de 48 dientes
- R3703 Trinquete 3/8" de 48 dientes
- S04H2 Llaves de 1/4": 4; 4,5; 5; 5,5; 6; 7; 8; 9; 10; 11; 12 y 13
- S04HD2 Llaves largas de 1/4": 8; 10; 12; y 13
- S04H3 Llaves de 3/8": 14; 15; 17; 18; 19; 20; 22 y 24
- S04HD3 Llaves largas 3/8": 14; 15 y 17
- S17H3 Vaso de bujias 3/8": 16 y 21
- S09H2 Puntas hexagonales: 3; 4; 5 y 6
- S07H2 Puntas torx: T10; T15; T20; T25; T27 y T30
- S10H2 Puntas planas: 4; 5,5 y 7
- S11H2 Puntas phillips: PH1; PH2 y PH3
- S24H2 2 Extensores
- S24H3 2 Extensores
- S16H302 Adaptador universal  
Adaptador de extensor 1/4" - 3/8"
- S15H356 Adaptador universal  
Adaptador de extensor 1/4" - 1/2"  
Mango



**S04H4125S**

83.00€

**Juego de llaves de vaso de 1/2" con 25 piezas**

Composición/ medidas en mm:

- R3704 Trinquete de 48 dientes
- S04H4 Llaves de vaso: 10 a 24; 27; 30 y 32  
Vaso de bujias: 16 y 21  
Extensores de 5" y 10"  
Cable en T corredizo  
Adaptador universal  
Maleta de transporte



**S04H4524S**

94.00€

**Juego de llaves de vaso de 1/2" con 24 piezas**

Composición/ medidas en mm:

- R3704 Trinquete de 48 dientes
- S04H4 Llaves de vaso: 10 a 24; 27; 30 y 32
- S24H4 Extensión de 5" y 10"
- S23H41300 Cable en "T" corredizo
- S15H472 Adaptador universal
- S22H41375 Mango flexible 15"  
Caja en metal



**S04H4728S**

94.00€

**Juego de llaves de vaso sextavadas de 1/2" con 28 piezas**

Composición/ medidas en mm:

- R3704 Trinquete de 48 dientes
- S04H4 Llaves de vaso: 8 a 28; 30; 32 y 34
- S24H4250 Extensión 10"
- S23H41300 Cable en "T" corredizo
- S15H472 Adaptador universal  
Caja en metal



**S04H6115S**

150.00€

**Juego de llaves de vaso de 3/4" con 14 piezas**

Composición/ medidas en mm:

- Trinquete
- Llaves de vaso: 22; 24; 27; 30; 32; 36; 38; 41; 46 y 50
- Extensión de 100 y 200
- Cable en "T" corredizo



**S04H6121S**

245.00€

**Juego de llaves de vaso de 3/4" con 20 piezas**

Composición/ medidas en mm:

- R1206 Trinquete reversible de 500
- S04H61 Llaves de vaso: 19; 21; 22; 24; 27; 30; 32; 36; 38; 41; 46 y 50
- S24H6 Extensores de 100; 200 y 400
- S22H6475 Cable articulado 475
- S16H3412 Adaptador 3/4"F para 1/2"M
- S16H3410 Adaptador 3/4"F para 1"M
- S15H6109 Adaptador universal  
Maleta de transporte



**S04H8115S**

485.00€

**Juego de llaves de vaso de 1" con 14 piezas**

Composición/ medidas en mm:

- Trinquete
- Llaves de vaso: 36; 41; 46; 50; 55; 60; 65; 70; 75 y 80
- Extensor de 200 y 400
- Cable de 550



**S06H4127S**

90.50€

**Juego de 27 puntas de 1/2" y 3/8"**

Composición/ medidas en mm:

- S09H4 Puntas allen de 1/2": 4; 5; 6; 7; 8; 10 y 12x55; 14x60; 17x70; 8x80 y 10x140
- S49H4 Puntas XZN de 1/2": M5; M6; M8; M10; M12; M14; M16x55; M10; M12x110 y M8x120
- S09H3 Puntas allen de 3/8": 4; 5; 6; 7; 8 y 10x48





**S06H425S**
**42.00€**
**Juego de 25 puntas torx de 1/2" y 1/4"**

Composición/ medidas en mm:

**S07H2** Puntas torx de 1/4": T8; T10; T15; T20; T25; T27 y T30x32

**S07H3** Puntas torx de 1/2": T40; T45; T50; T55 y T60x55

**S06H2** Llaves de tornillos torx 1/4": E4; E5; E6; E7 y E8

**S06H4** Llaves de tornillos torx 1/2": E10; E11; E12; E14 y E18

**H08** Llaves macho torx: T6; T8 y T10

**S07H4109S**
**30.00€**
**Juego de 9 llaves bits torx de 1/2"**

Composición:

T20; T25; T27; T30; T40; T50; T55 y T60

**S07H4932S**
**110.00€**
**Juego de 32 llaves bits torx de 1/2"**

Composición:

Puntas 55mm: T20; T25; T27; T30; T40; T45; T50; T55; T60 y T70

Puntas 100mm: T20; T25; T27; T30; T40; T45; T50; T55; T60 y T70

Puntas 140mm: T40; T45; T50; T55; T60 y T70

Puntas 200mm: T40; T45; T50; T55; T60 y T70

Maleta de transporte

**S09H4109S**
**30.00€**
**Juego de 9 llaves bits hexagonales de 1/2"**

Composición:

H3; H4; H5; H6; H7; H8; H10; H12 y H14

**S63H4132S**
**107.00€**
**Juego de 32 llaves bits ribe (Ribe) 1/2"**

Composición:

Puntas 55mm: M5; M6; M7; M8; M9; M10; M12; M13 y M16

Puntas 100mm: M5; M6; M7; M8; M9; M10; M12; M13 y M16

Puntas 140mm: M8; M9; M10; M12; M13 y M14

Puntas 200mm: M8; M9; M10; M12; M13 y M14

Maleta de transporte

**S64H4126S**
**90.00€**
**Juego de 26 llaves bits ZXN 1/2"**

Composición:

Puntas 55mm: M5; M6; M8; M10; M12; M14 y M16

Puntas 100mm: M5; M6; M8; M10; M12 y M14

Puntas 140mm: M5; M6; M8; M10; M12 y M14

Puntas 200mm: M8; M10; M12 y M14

Maleta de transporte

**S04H52460S**
**130.00€**
**Juego de 60 piezas de herramienta de 1/2" y 1/4"**

Composición/ medidas en mm:

Trinquete 1/2" de 36 dientes

Llaves de vaso 1/2": 12; 13; 14; 15; 17; 18; 19; 22 y 24

Llaves de vaso 1/4": 6; 8; 9; 10; 11; 12 y 13

Vaso de bujías 1/2": 16 y 21

Llaves mixtas: 8; 10; 12; 13; 14 y 17

Juego de llaves plana/ phillips

Bits de 1/4": planos, torx y phillips

Soporte bits de 1/4"

Extensores 1/2" de 125 y 250

Extensor 1/4" com 75

Extensión flexible de 1/4"

Adaptador 3/8"F para 1/2"M

Cable "T" corredizo 1/4"

Alicata ajustable

Alicata universal

Puntas de 1/4"

Martillo

Cardán de 1/2"

Mango de 1/4"



**S04H52477S**

173.00€

**Juego de 77 piezas de herramienta de 1/2" y 1/4"**

Composición/ medidas en mm:

- R2904 Trinquete 1/2" reversible de 36 dientes
- R2902 Trinquete 1/4" reversible de 36 dientes
- S04H4 Llaves de vaso 1/2": 12 a 32
- S04H21 Llaves de vaso 1/4": 4 a 12
- S04HD21 Llaves de vaso largas 1/4": 8; 10; 12 y 13
- S17H Vaso de bujias 1/2": 16 y 21mm
- W26 Llaves fija/ estrella: 8; 10; 12; 13; 14; 15; 17 y 19
- D04 Juego de destornilladores
- S24H Extensores 1/2" de 125 y 250
- S24H275 Extensor 1/4" con 75
- S15H472 Adaptador universal 1/2"
- S15H240 Adaptador universal 1/4"
- S16H304 Adaptador 3/8"F para 1/2"M
- S23H21130 Cable "T" corredizo 1/4"
- P2810 Alicata ajustable
- P088 Alicata universal
- M09500 Martillo mecánico 500g
- Maleta de transporte



**S04H52478S**

199.00€

**Juego de 78 piezas de herramienta de 1/2" y 1/4"**

Composición/ medidas en mm:

- Trinquete 1/2" de 48 dientes
- Trinquete 1/4" de 48 dientes
- Llaves de vaso 1/4": 5 a 11
- Llaves de vaso largas 1/4": 5 a 12
- Vaso de bujias 1/2": 16 y 21
- Llaves de vaso 1/2": 12 a 19; 22; 24; 27 y 32
- Llaves mixtas: 6 a 17; 19, 21; 22 y 24
- Llaves allen hexagonales: 2,5 a 10
- Llaves allen torx: T10; T15; T20; T25; T27; T30 y T40
- Llaves estrella abierta: 8x10; 11x13; 12x14 y 17x19
- Juego de llaves fenda/ phillips
- Extensores 1/2" de 125 y 250
- Extensor 1/4" con 50
- Adaptador 3/8"F para 1/2"M
- Cable "T" corredizo 1/4"
- Alicata de presión
- Cardán de 1/2" y 1/4"
- Mango de 1/4"



**S04H624101S**
**235.00€**
**Juego de 101 piezas de herramienta de 1/2" y 1/4"**

Composición/ medidas en mm:

- R2904 Trinquete 1/2" reversible de 36 dientes
- R2902 Trinquete 1/4" reversible de 36 dientes
- S04H4 Llaves de vaso allen 1/2": 8 a 24; 27; 30 y 32
- S04H2 Llaves de vaso allen 1/4": 4; 4,5; 5; 5,5; 6; 7; 8; 9 y 10
- S17H4 Vasos de bujias 1/2": 16 y 21
- S06H4 Llaves de vaso torx 1/2": E11; E12; E14; E16 y E18
- W24 Llaves estrella abierta: 8x10; 11x13; 12x14 y 17x19
- W26 Llaves fija/ estrella: 8; 10 a 19; 21; 22 y 24
- D04 Juego destornilladores
- S24H4 Extensores 1/2" de 125 y 250
- S21H4 Extensor 1/2" de 50
- S24H2 Extensores 1/4" de 75 y 100
- S27H4 Extensor flexible 1/4"
- S14H4 Adaptador universal 1/2"
- S15H2 Adaptador universal 1/4"
- S23H2 Cable "T" corredizo 1/4"
- S23H4 Cable "T" corredizo 1/2"
- W27AS8 Alicata ajustable
- P087 Alicata universal
- AG010034 Imán
- Puntas de 1/4"
- Puntas ZXN - M6; M8; M10 y M12
- Maleta de transporte

**S04H524127S**
**350.00€**
**Juego de 127 piezas de herramienta de 1/2" y 1/4"**

Composición/ medidas en mm:

- R2904 Trinquete 1/2" reversible de 36 dientes
- R2902 Trinquete 1/4" reversible de 36 dientes
- Llaves de vaso 1/2": 8 a 11; 13 a 19; 21; 22; 24; 27; 30 y 32
- Llaves de vaso 1/4": 4; 4,5; 5; 5,5; 6 a 13
- Llaves de vaso larga 1/2": 10; 12; 13; 14; 15; 17 y 19
- Llaves de vaso larga 1/4": 7; 8; 10; 12 y 13
- Vasos de bujias 1/2": 16 y 21
- Llaves de vaso torx 1/4": E4; E5; E6; E7 y E8
- Llaves torx 1/2": E10; E12; E14; E16; E18; E20; E22 y E24
- Llaves mixtas: 6 a 17; 19; 21; 22; 24; 27; 30 y 32
- Llaves estrella abierta: 8x10; 9x11; 12x13; 14x17 y 19x19
- Llaves hexagonales cortas: 1,5; 2; 2,5; 3; 4; 5; 6; 8 y 10
- Llaves torx: T10; T15; T20; T25; T27; T30 y T40
- Llaves destornilladores con mango antideslizante
- Llaves phillips con mango antideslizante
- Juego de botadores y cortafrios
- Extensores 1/4" de 50x150 y de 1/2" 50mm
- Extensores 1/2" de 125 y 250 y de 1/4" de 75
- Extensor flexible 1/4" de 145
- Cable "T" corredizo 1/4" de 130 y 1/2" de 250
- Cable articulado 1/2" de 375
- Alicata ajustable
- Alicata de corte
- Alicata universal
- Imán
- Martillo mecánico 500g
- Cardán de 1/2" y 1/4"
- Maleta de transporte



**S04H21**

Llave de vaso de 6 caras 1/4"

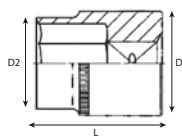

Ref.	Medida (mm)	D1 (mm)	D2 (mm)	L (mm)	Precio
S04H2104	4	11,8	6,8	25	0.70€
S04H21045	4,5	11,8	7,3	25	0.70€
S04H2105	5	11,8	8	25	0.70€
S04H21055	5,5	11,8	8,6	25	0.75€
S04H2106	6	11,8	9,2	25	0.75€
S04H2107	7	11,8	10,5	25	0.75€
S04H2108	8	11,4	11,7	25	0.75€
S04H2109	9	11,6	12,7	25	0.80€
S04H2110	10	12,8	13,7	25	0.80€
S04H2111	11	14,4	15,7	25	0.90€
S04H2112	12	13,7	16,6	25	0.90€
S04H2113	13	13,9	17,6	25	0.90€
S04H2114	14	17,5	20	25	1.00€



**S04HD21**

Llave de vaso de 6 caras larga 1/4"

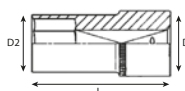

Ref.	Medida (mm)	D1 (mm)	D2 (mm)	L (mm)	Precio
S04HD2106	6	12	9,2	50	1.20€
S04HD2107	7	12	10,5	50	1.20€
S04HD2108	8	11,5	12	50	1.20€
S04HD2110	10	13,3	14,4	50	1.30€
S04HD2111	11	14,8	15,9	50	1.40€
S04HD2112	12	15,8	17	50	1.50€
S04HD2113	13	16,8	17,8	50	1.60€

**S04H31**

Llave de vaso de 6 caras 3/8"

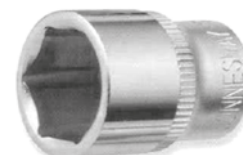
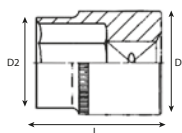

Ref.	Medida (mm)	D1 (mm)	D2 (mm)	L (mm)	Precio
S04H3106	6	16,8	9,6	28	1.00€
S04H3107	7	16,8	10,7	28	1.00€
S04H3108	8	16,8	12	28	1.00€
S04H3109	9	16,8	13,3	28	1.00€
S04H3110	10	16,8	14,4	28	1.00€
S04H3111	11	16,8	15,8	28	1.00€
S04H3112	12	16	16,8	28	1.00€
S04H3113	13	18	19	28	1.00€
S04H3114	14	18,8	19,7	28	1.00€
S04H3115	15	19,8	20,8	28	1.10€
S04H3116	16	20,8	22	28	1.10€
S04H3117	17	22	23,8	28	1.30€
S04H3118	18	24,1	25,7	28	1.40€
S04H3119	19	24,1	25,7	28	1.40€
S04H3120	20	25	27,6	32	1.60€
S04H3121	21	25	27,6	32	1.70€
S04H3122	22	27,8	29,6	32	1.80€
S04H3124	24	29,8	31	32	1.90€

**S04HD31**

Llave de vaso de 6 caras larga 3/8"

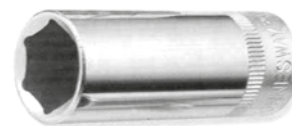
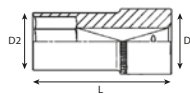

Ref.	Medida (mm)	D1 (mm)	D2 (mm)	L (mm)	Precio
S04HD3110	10	17	14,4	63	1.80€
S04HD3111	11	17	15,8	63	1.80€
S04HD3112	12	17	17,7	63	1.90€
S04HD3113	13	18	19	63	1.90€
S04HD3114	14	18,8	19,7	63	2.00€
S04HD3115	15	19,8	20,8	63	2.10€
S04HD3117	17	22,8	23,8	63	2.20€
S04HD3119	19	23,8	26	63	2.50€
S04HD3121	21	25,8	28	63	3.00€

**S04H41**

Llave de vaso de 6 caras 1/2"

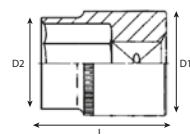

Ref.	Medida (mm)	D1 (mm)	D2 (mm)	L (mm)	Precio
S04H4108	8	21,8	13,8	38	1.30€
S04H4109	9	21,8	14,3	38	1.30€
S04H4110	10	21,8	15,4	38	1.30€
S04H4111	11	21,8	16,7	38	1.30€
S04H4112	12	21,8	18	38	1.30€
S04H4113	13	21,8	19	38	1.30€
S04H4114	14	22	20,3	38	1.40€
S04H4115	15	22	21,3	38	1.40€
S04H4116	16	22	23,3	38	1.50€
S04H4117	17	23	23,8	38	1.50€
S04H4118	18	23,5	24,8	38	1.60€
S04H4119	19	24	27	38	1.70€
S04H4120	20	24	28	38	2.00€
S04H4121	21	24	29	38	2.10€
S04H4122	22	28	30	38	2.20€
S04H4123	23	28	30,7	38	2.40€
S04H4124	24	28	31,8	38	2.50€
S04H4125	25	28	33,8	38	2.80€
S04H4126	26	30	34	42	2.90€
S04H4127	27	28	35,7	42	3.00€
S04H4128	28	30	38	42	3.20€
S04H4129	29	32	38	42	3.50€
S04H4130	30	34	39,8	42	3.60€
S04H4132	32	36	42	42	3.90€
S04H4134	34	40	45	48	5.10€
S04H4136	36	41	48	48	6.40€

**S04HD41**

Llave de vaso de 6 caras larga 1/2"

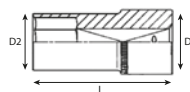

Ref.	Medida (mm)	D1 (mm)	D2 (mm)	L (mm)	Precio
S04HD4109	12	21,8	12,7	76	2.90€
S04HD4110	10	21,8	15,4	76	2.90€
S04HD4111	11	21,8	16,7	76	3.00€
S04HD4112	12	21,8	18	76	3.00€
S04HD4113	13	21,8	19	76	3.00€
S04HD4114	14	22	20,3	76	3.10€
S04HD4115	15	22	21,3	76	3.20€
S04HD4116	16	22	23	76	3.20€
S04HD4117	17	23	23,8	76	3.30€
S04HD4118	18	23	24,8	76	3.40€
S04HD4119	19	24	25,8	76	3.40€
S04HD4120	20	24	28	76	3.40€
S04HD4121	21	24	29	76	3.50€
S04HD4122	22	26	30	76	3.70€
S04HD4123	23	28	31,8	76	3.80€
S04HD4124	24	28	31,8	76	3.90€
S04HD4125	25	28	33,8	76	5.20€
S04HD4126	26	28	33,8	76	5.50€
S04HD4127	27	28	35,7	76	6.00€
S04HD4128	28	30	38	76	6.20€
S04HD4130	30	34	39,8	76	7.00€
S04HD4132	32	36	42	76	7.20€



**S04HD4115**

39.50€

Juego de 10 llaves de vaso largas de 1/2" - 6 caras

Composición:

S04HD4 Llaves: 10; 11; 13; 14; 15; 17; 19; 21; 22 y 24mm



**S04H61**

Llave de vaso de 6 caras 3/4"

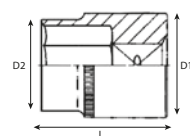

Ref.	Medida (mm)	D1 (mm)	D2 (mm)	L (mm)	Precio
S04H6119	19	30	36	49,5	4.80€
S04H6121	21	32	36	49,5	4.80€
S04H6122	22	33	36	49,5	4.80€
S04H6124	24	35	36	49,5	4.80€
S04H6127	27	38	36	52	4.80€
S04H6128	28	39	36	52	4.90€
S04H6130	30	42	38	54	5.70€
S04H6132	32	44	38	56	6.00€
S04H6134	34	46	38	58	6.60€
S04H6136	36	50	42	58	7.10€
S04H6138	38	52	45	60	7.40€
S04H6141	41	56	45	64	8.10€
S04H6146	46	62	48	68	10.10€
S04H6150	50	68	48	72	11.20€

**S04H63**

Llave de vaso 3/4" - 12 caras

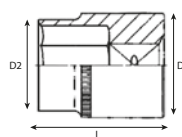

Ref.	Medida (mm)	D1 (mm)	D2 (mm)	L (mm)	Precio
S04H6319	19	30	36	49,5	4.70€
S04H6321	21	32	36	49,5	4.80€
S04H6322	22	33	36	49,5	4.80€
S04H6323	23	34	36	49,5	4.80€
S04H6324	24	35	36	49,5	5.00€
S04H6325	25				5.50€
S04H6326	26				5.60€
S04H6327	27	38	36	52	5.80€
S04H6329	29	40	38	53	5.90€
S04H6330	30	42	38	54	6.30€
S04H6332	32	44	38	56	6.50€
S04H6334	34	46	38	58	6.90€
S04H6336	36	50	42	58	7.60€
S04H6338	38	52	45	60	8.00€
S04H6341	41	56	45	64	9.40€
S04H6346	46	62	48	68	11.00€
S04H6350	50	68	48	72	12.50€
S04H6355	55	74	48	76	17.30€
S04H6356	56	75	48	76	17.30€
S04H6360	60	70	48	78	19.30€
S04H6365	65	87	60	85	25.00€

**S04H64**

Llave de vaso 3/4" - 12 caras (en pulgadas)

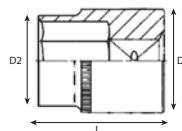

Ref.	Medida	D1 (mm)	D2 (mm)	L (mm)	Precio
S04H6419	3/4"	30	36	49,5	5.30€
S04H6421	13/16"	32	36	49,5	5.30€
S04H6422	7/8"	33	36	49,5	5.40€
S04H6424	15/16"	34	36	49,5	5.40€
S04H6426	1"	35	36	49,5	5.50€
S04H6427	1-1/16"	38	36	52	5.60€
S04H6429	1-1/18"	40	38	53	5.90€
S04H6430	1-3/16"	42	38	54	5.90€
S04H6432	1-1/4"	44	38	56	6.00€
S04H6433	1-5/16"	46	38	56	6.10€
S04H6435	1-3/8"	48	42	58	7.00€
S04H6436	1-7/16"	50	42	58	7.10€
S04H6438	1-1/2"	52	45	60	7.80€
S04H6440	1-9/16"	52	45	60	8.70€
S04H6441	1-5/8"	56	45	64	8.80€
S04H6443	1-11/16"	56	45	64	9.20€
S04H6444	1-3/4"	56	45	64	9.60€
S04H6446	1-13/16"	62	48	68	10.00€
S04H6447	1-7/8"	62	48	68	12.60€
S04H6450	2"	68	48	72	12.80€
S04H6456	2/14"	75	48	76	17.10€

**S04H83**

Llave de vaso 1" - 12 caras

Ref.	Medida (mm)	D1 (mm)	D2 (mm)	L (mm)	Precio
S04H8355	55	76	57	80	22.80€
S04H8360	60	82	57	84	27.90€
S04H8365	65	88	57	87	32.30€

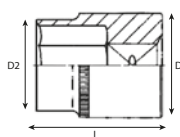

**S05H48**

Llave de vaso 1/2" - 12 caras

Ref.	Medida (mm)	D1 (mm)	D2 (mm)	L (mm)	Precio
S05H4811	11	21,8	15,4	38	1.50€
S05H4813	13	21,8	19	38	1.50€
S05H4814	14	22	20,3	38	1.50€
S05H4816	16	22	22	38	1.60€
S05H4818	18	24,8	24,8	38	1.80€
S05H4819	19	25,8	25,8	38	1.80€
S05H4820	20	27,9	27,9	38	1.90€
S05H4821	21	27,8	27,9	38	2.20€
S05H4822	22	30	30	38	2.50€
S05H4824	24	31,8	31,8	38	3.00€
S05H4825	25				3.50€
S05H4827	27				4.00€
S05H4830	30				4.40€
S05H4832	32				5.50€

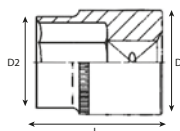

**S05H4113S**

27.00€

Juego de 13 llaves de vaso de 1/2" - 12 caras

Composición:

S05H4 Llaves: 10; 12; 13; 14; 15; 16; 17; 18; 19; 20; 21; 22 y 24mm



**S05H4213S**

33.50€

Juego de 13 llaves de vaso de 1/2" SAE

Composición:

Llaves: 3/8"; 7/16"; 1/2"; 9/16"; 5/8"; 11/16"; 3/4"; 13/16"; 7/8"; 15/16"; 1"; 1-1/16" y 1-1/8"



**S05HD41**

Llave de vaso 6 caras larga 1/2"

Ref.	Medida (mm)	D1 (mm)	D2 (mm)	L (mm)	Precio
S05HD4110	10	21,8	15,4	76	2.80€
S05HD4111	11	21,8	16,7	76	3.00€
S05HD4112	12	21,8	18	76	3.00€
S05HD4113	13	21,8	19	76	3.00€
S05HD4117	17	23,8	23,8	76	3.10€
S05HD4118	18	24,8	16,7	76	3.20€
S05HD4119	19	25,8	25,8	76	3.40€
S05HD4120	20	27,9	27,9	76	3.40€
S05HD4121	21	27,9	27,9	76	3.60€
S05HD4122	22	30	30	76	3.60€
S05HD4123	23	31,8	31,8	76	4.10€
S05HD4124	24	31,8	31,8	76	5.00€
S05HD4127	27	36	36	76	6.00€
S05HD4130	30	40	40	76	6.80€
S05HD4132	32	42	42	76	7.20€

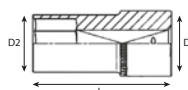



**S05HD4113S**
**52.00€**
**Juego de 13 llaves de vaso largas 1/2" - 6 caras**

Composición:

**S05HD4** Llaves: 11; 13; 14; 15; 17; 19; 21; 22; 23; 24; 27; 30 y 32mm

**S05HD4213S**
**42.50€**
**Juego de 13 llaves de vaso largas 1/2" SAE**

Composición:

Llaves: 7/16"; 1/2"; 9/16"; 5/8"; 11/16"; 3/4"; 13/16"; 7/8"; 15/16"; 1"; 1-1/16"; 1-1/8" y 1-1/4"

**S06H37S**
**13.50€**
**Juego de 7 llaves de vaso para tornillos torx 3/8"**

Composición:

**S06H3** Llaves: E10; E11; E12; E14; E16; E18 y E20

**S06H49S**
**20.00€**
**Juego de 9 llaves de vaso para tornillos torx 1/2"**

Composición:

**S06H4** Llaves: E10; E11; E12; E14; E16; E18; E20; E22 y E24

**S66H41**
**Llave de vaso de 1/2" - 12 caras**

Ref.	Medida (mm)	Precio
<b>S66H4108</b>	8	1.30€
<b>S66H4110</b>	10	1.40€
<b>S66H4112</b>	12	1.40€
<b>S66H4115</b>	15	1.50€
<b>S66H4117</b>	17	1.50€
<b>S66H4126</b>	26	3.70€
<b>S66H4128</b>	28	4.10€
<b>S66H4136</b>	36	7.30€

**S66HD41**
**Llave de vaso largas de 1/2" - 12 caras**



Ref.	Medida (mm)	Precio
<b>S66HD4110</b>	10	2.30€
<b>S66HD4111</b>	11	2.30€
<b>S66HD4112</b>	12	2.30€
<b>S66HD4113</b>	13	2.30€
<b>S66HD4114</b>	14	2.40€
<b>S66HD4115</b>	15	2.50€
<b>S66HD4116</b>	16	2.50€
<b>S66HD4117</b>	17	2.50€
<b>S66HD4118</b>	18	2.60€
<b>S66HD4119</b>	19	2.70€
<b>S66HD4120</b>	20	2.80€
<b>S66HD4121</b>	21	2.90€
<b>S66HD4122</b>	22	3.30€
<b>S66HD4123</b>	23	3.40€
<b>S66HD4124</b>	24	3.50€
<b>S66HD4127</b>	27	4.50€
<b>S66HD4130</b>	30	5.50€
<b>S66HD4132</b>	32	6.00€

PHILLIPS	DESTORNIL.	TORX	TORX TEMP.	HEXAGONAL	XZN
----------	------------	------	------------	-----------	-----

**S06H2**

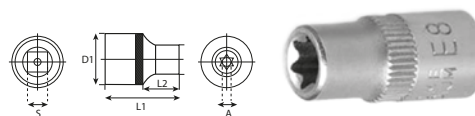

Llave de vaso torx 1/4"



Ref.	Medida	D1 (mm)	D2 (mm)	L1 (mm)	L2 (mm)	Precio
S06H204	E4	12	6,2	25	11	1.00€
S06H205	E5	12	7,2	25	11	1.00€
S06H206	E6	12	8,2	25	11	1.00€
S06H207	E7	12	9	25	11	1.00€
S06H208	E8	12	10,3	25	11	1.00€
S06H210	E10					1.10€
S06H211	E11					1.10€

**S06H4**



Llave de vaso torx 1/2"



Ref.	Medida	D1 (mm)	D2 (mm)	L1 (mm)	L2 (mm)	Precio
S06H410	E10	22	13,2	38	17	2.00€
S06H411	E11	22	13,9	38	17	2.00€
S06H412	E12	22	15	38	17	2.00€
S06H414	E14	22	16,7	38	17	2.10€
S06H416	E16	22	18,8	38	17	2.10€
S06H418	E18	22	20,8	38	17	2.10€
S06H420	E20	22	23	38	17	2.10€
S06H422	E22	22	25	38	17	2.10€
S06H424	E24	22	27	38	17	2.50€

**S07H2**



Llave de vaso punta torx 1/4"



Ref.	Medida	L1 (mm)	L2 (mm)	L3 (mm)	L (mm)	D (mm)	d (mm)	Precio
S07H206	T6	13	19	25	37	12	10,8	1.00€
S07H207	T7	13	19	25	37	12	10,8	1.00€
S07H208	T8	13	19	25	37	12	10,8	1.00€
S07H209	T9	13	19	25	37	12	10,8	1.00€
S07H210	T10	13	19	25	37	12	10,8	1.00€
S07H215	T15	13	19	25	37	12	10,8	1.00€
S07H220	T20	13	19	25	37	12	10,8	1.00€
S07H225	T25	13	19	25	37	12	10,8	1.00€
S07H227	T27	13	19	25	37	12	10,8	1.00€
S07H230	T30	13	19	25	37	12	10,8	1.00€
S07H240	T40	13	19	25	37	12	10,8	1.00€

**S07H3**

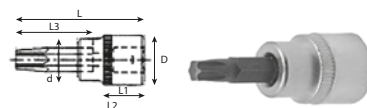
**Llave de vaso punta torx 3/8"**

Ref.	Medida	L1 (mm)	L2 (mm)	L3 (mm)	L (mm)	D (mm)	d (mm)	Precio
S07H310	T10	16,5	26	30	48	18	13,8	1.10€
S07H315	T15	16,5	26	30	48	18	13,8	1.10€
S07H320	T20	16,5	26	30	48	18	13,8	1.10€
S07H325	T25	16,5	26	30	48	18	13,8	1.10€
S07H327	T27	16,5	26	30	48	18	13,8	1.10€
S07H330	T30	16,5	26	30	48	18	13,8	1.10€
S07H340	T40	16,5	26	30	48	18	13,8	1.10€
S07H345	T45	16,5	26	30	48	18	15,8	1.30€
S07H350	T50	16,5	26	30	48	18	15,8	1.30€
S07H355	T55	16,5	26	30	48	18	16,1	1.40€
S07H360	T60	16,5	26	30	48	18	16,1	1.50€

**S07H4**

**Llave de vaso punta torx 1/2"**

Ref.	Medida	L1 (mm)	L2 (mm)	L3 (mm)	L (mm)	D (mm)	d (mm)	Precio
S07H420	T20	20	38	30	55	22	15	2.10€
S07H425	T25	20	38	30	55	22	15	2.10€
S07H427	T27	20	38	30	55	22	15	2.10€
S07H430	T30	20	38	30	55	22	15	2.10€
S07H440	T40	20	38	30	55	22	15	2.10€
S07H445	T45	20	38	30	55	22	15	2.10€
S07H450	T50	20	38	30	55	22	15	2.20€
S07H455	T55	20	38	30	55	22	17	2.30€
S07H460	T60	20	38	30	55	24	22	2.40€
S07H470	T70	20	38	30	55	24	22	2.50€

**S07H43**

**Llave de vaso punta torx 1/2"**

Ref.	Medida	L1 (mm)	L2 (mm)	L3 (mm)	L (mm)	D (mm)	d (mm)	Precio
S07H4320	T20	20	38	75	100	24	15	3.00€
S07H4325	T25	20	38	75	100	24	15	3.00€
S07H4327	T27	20	38	75	100	24	15	3.00€
S07H4330	T30	20	38	75	100	24	15	3.10€
S07H4340	T40	20	38	75	100	24	15	3.10€
S07H4345	T45	20	38	75	100	24	15	3.10€
S07H4350	T50	20	38	75	100	24	15	3.10€
S07H4352	T52	20	38	75	100	24	15	3.20€
S07H4355	T55	20	38	75	100	24	17	3.20€
S07H4360	T60	20	38	75	100	24	22	3.40€
S07H4370	T70	20	38	75	100	24	22	3.50€

**S07H45**

**Llave de vaso punta torx de 1/2"**

Ref.	Medida	Longitud (mm)	Precio
S07H4530	T30	200	5.00€
S07H4540	T40	200	5.00€
S07H4545	T45	200	5.00€

**S08H311S**

**12.00€**
**Juego de 11 puntas de 1/4" y 3/8" torx tamperproof**

Composición:

Llaves de 1/4": T8; T10; T15; T20; T25 y T27

Llaves de 3/8": T30; T40; T45; T50 y T55

**S09H2**

Llave de vaso punta allen 1/4"

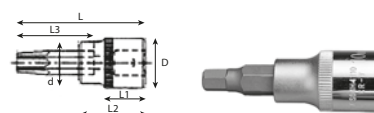

Ref.	Medida	L1 (mm)	L2 (mm)	L3 (mm)	L (mm)	D (mm)	d (mm)	Precio
S09H203	H3	13	19	25	37	12	10,8	1.00€
S09H204	H4	13	19	25	37	12	10,8	1.00€
S09H205	H5	13	19	25	37	12	10,8	1.00€
S09H206	H6	13	19	25	37	12	10,8	1.00€
S09H207	H7	13	19	25	37	12	10,8	1.00€

**S09H3**

Llave de vaso punta allen 3/8"



Ref.	Medida	L1 (mm)	L2 (mm)	L3 (mm)	L (mm)	D (mm)	d (mm)	Precio
S09H303	H3	16,5	26	30	48	18	13,8	1.20€
S09H304	H4	16,5	26	30	48	18	13,8	1.20€
S09H305	H5	16,5	26	30	48	18	13,8	1.20€
S09H306	H6	16,5	26	30	48	18	13,8	1.20€
S09H307	H7	16,5	26	30	48	18	15,8	1.20€
S09H308	H8	16,5	26	30	48	18	15,8	1.30€
S09H310	H10	16,5	26	30	48	18	16,1	1.30€
S09H312	H12	16,5	26	30	48	18	16,1	1.50€
S09H314	H14	16,5	26	30	48	18	16,1	1.70€

**S09H4**

Llave de vaso punta allen 1/2"



Ref.	Medida	L1 (mm)	L2 (mm)	L3 (mm)	L (mm)	D (mm)	d (mm)	Precio
S09H404	H4	20	38	30	55	24	15	2.20€
S09H405	H5	20	38	30	55	24	15	2.20€
S09H406	H6	20	38	30	55	24	15	2.20€
S09H407	H7	20	38	30	55	24	15	2.20€
S09H408	H8	20	38	30	55	24	15	2.20€
S09H410	H10	20	38	30	55	24	17,8	2.30€
S09H412	H12	20	38	30	55	24	22	2.50€
S09H414	H14	20	38	30	55	24	22	2.50€
S09H416	H16	20	38	30	55	24	22	2.70€
S09H417	H17	20	38	30	55	24	22	3.20€
S09H419	H19	20	38	30	55	24	22	3.60€

**S09H3**

Llave de vaso punta allen 1/2"



Ref.	Medida	L1 (mm)	L2 (mm)	L3 (mm)	L (mm)	D (mm)	d (mm)	Precio
S09H4304	H4	20	38	75	100	24	15	3.00€
S09H4305	H5	20	38	75	100	24	15	3.00€
S09H4306	H6	20	38	75	100	24	15	3.00€
S09H4307	H7	20	38	75	100	24	15	3.00€
S09H4308	H8	20	38	75	100	24	15	3.00€
S09H4309	H9	20	38	75	100	24	15	3.10€
S09H4310	H10	20	38	75	100	24	20,8	3.20€
S09H4312	H12	20	38	75	100	24	22	3.40€
S09H4314	H14	20	38	75	100	24	22	3.40€
S09H4316	H16	20	38	75	100	24	22	4.00€
S09H4317	H17	20	38	75	100	24	22	4.60€
S09H4319	H19	20	38	75	100	24	22	6.20€

**S10H2**

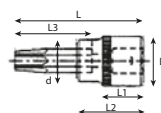
**Llave de vaso punta plana 1/4"**

Ref.	Medida (mm)	L1 (mm)	L2 (mm)	L3 (mm)	L (mm)	D (mm)	d (mm)	Precio
S10H230	3	13	21	25	37	12	10,8	1.00€
S10H235	3,5	13	21	25	37	12	10,8	1.00€
S10H240	4	13	21	25	37	12	10,8	1.00€
S10H245	4,5	13	21	25	37	12	10,8	1.00€
S10H250	5	13	21	25	37	12	10,8	1.00€
S10H255	5,5	13	21	25	37	12	10,8	1.00€
S10H260	6	13	21	25	37	12	10,8	1.00€
S10H270	7	13	21	25	37	12	10,8	1.00€

**S10H3**

**Llave de vaso punta plana 3/8"**

Ref.	Medida (mm)	L1 (mm)	L2 (mm)	L3 (mm)	L (mm)	D (mm)	d (mm)	Precio
S10H340	4	15,5	26,5	30	48	18	13,8	1.00€
S10H350	5	15,5	26,5	30	48	18	13,8	1.00€
S10H355	5,5	15,5	26,5	30	48	18	13,8	1.00€
S10H360	6	15,5	26,5	30	48	18	13,8	1.00€
S10H370	7	15,5	26,5	30	48	18	13,8	1.10€
S10H380	8	15,5	26,5	30	48	18	15,8	1.10€
S10H3100	10	15,5	26,5	30	48	20	17,8	1.30€
S10H3120	12	15,5	26,5	30	48	20	17,8	1.50€

**S10H4**

**Llave de vaso punta plana 1/2"**

Ref.	Medida (mm)	L1 (mm)	L2 (mm)	L3 (mm)	L (mm)	D (mm)	d (mm)	Precio
S10H480	8	20	36	30	55	22	17,8	2.10€
S10H490	9	20	36	30	55	22	17,8	2.30€
S10H4100	10	20	36	30	55	22	17,8	2.30€
S10H4110	11	20	36	30	55	24	20,8	2.40€
S10H4120	12	20	36	30	55	24	20,8	2.40€

**S11H2**

**Llave de vaso punta phillips 1/4"**

Ref.	Medida	L1 (mm)	L2 (mm)	L3 (mm)	L (mm)	D (mm)	d (mm)	Precio
S11H200	PH0	13	19	25	37	12	10,8	1.00€
S11H201	PH1	13	19	25	37	12	10,8	1.00€
S11H202	PH2	13	19	25	37	12	10,8	1.00€
S11H203	PH3	13	19	25	37	12	10,8	1.00€

**S11H3**



Llave de vaso punta phillips 3/8"

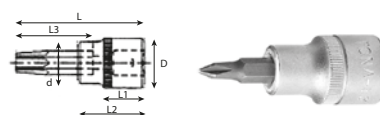

Ref.	Medida	L1 (mm)	L2 (mm)	L3 (mm)	L (mm)	D (mm)	d (mm)	Precio
S11H300	PH0	16,5	26	30	48	18	13,8	1.10€
S11H301	PH1	16,5	26	30	48	18	13,8	1.10€
S11H302	PH2	16,5	26	30	48	18	13,8	1.10€
S11H303	PH3	16,5	26	30	48	18	15,8	1.10€
S11H304	PH4	16,5	26	30	48	18	15,8	1.30€

**S11H4**



Llave de vaso punta phillips 1/2"



Ref.	Medida	L1 (mm)	L2 (mm)	L3 (mm)	L (mm)	D (mm)	d (mm)	Precio
S11H402	PH2	55	38	30	55	24	15	2.10€
S11H403	PH3	55	38	30	55	24	15	2.10€
S11H404	PH4	55	38	30	55	24	15	2.10€

**S50H3106S**



10.60€

Juego de 6 puntas allen 3/8"

Composición:

Llaves: 4; 5; 6; 7; 8 y 10 mm



**S50H3206S**



11.00€

Juego de 6 puntas allen 3/8" SAE

Composición:

Llaves: 5/32"; 3/16"; 7/32"; 1/4"; 5/16" y 3/8"



**S54H5509S**



12.90€

Juego de 9 llaves de torx de 1/4" y 3/8"

Composición:

S54H2 Llaves de 1/4": T10; T15; T20 y T25

S54H3 Llaves de 3/8": T25; T30; T40; T45 y T50



**S63H4507S**

18.30€

Juego de 7 puntas largas allen (Ribe) 3/8" y 1/2"

Composición:

Puntas 3/8" de 90 mm: M6; M7; M8 y M10

Puntas 1/2" de 100 mm: M12; M13 y M14



**S63H33**



Llave de vaso Ribe 3/8"

Ref.	Medida	Longitud (mm)	Precio
S63H3306	T6	90	1.40€
S63H3307	T7	90	1.70€
S63H3308	T8	90	1.90€
S63H3310	T10	90	2.50€

**S63H43**



Llave de vaso Ribe 1/2"

Ref.	Medida	Longitud (mm)	Precio
S63H4306	T6	100	2.90€
S63H4307	T7	100	3.00€
S63H4308	T8	100	3.10€
S63H4310	T10	100	3.20€
S63H4312	T12	100	3.30€
S63H4313	T13	100	3.40€

**S63H44**



Llave de vaso Ribe 1/2"

Ref.	Medida	Longitud (mm)	Precio
S63H4405	M5	55	2.40€
S63H4406	M6	55	2.50€
S63H4407	M7	55	2.60€
S63H4408	M8	55	2.70€
S63H4409	M9	55	2.80€
S63H4410	M10	55	2.90€
S63H4412	M12	55	3.20€
S63H4413	M13	55	3.70€
S63H4414	M14	55	4.30€

**S63H46**

Llave de vaso Ribe 1/2"

Ref.	Medida	Longitud (mm)	Precio
S63H4605	T5	100	2.90€
S63H4606	T6	100	2.90€
S63H4607	T7	100	3.00€
S63H4608	T8	100	3.00€
S63H4609	T9	100	3.20€
S63H4610	T10	100	3.20€
S63H4612	T12	100	3.60€
S63H4613	T13	100	4.60€
S63H4614	T14	100	4.80€

**S63H47**

Llave de vaso Ribe 1/2"

Ref.	Medida	Longitud (mm)	Precio
S63H4708	M8	140	3.30€
S63H4709	M9	140	3.40€
S63H4710	M10	140	3.50€
S63H4712	M12	140	4.10€
S63H4713	M13	140	4.90€
S63H4714	M14	140	5.00€

**S63H48**

Llave de vaso Ribe 1/2"

Ref.	Medida	Longitud (mm)	Precio
S63H4808	M8	200	4.20€
S63H4809	M9	200	4.30€
S63H4810	M10	200	4.40€
S63H4812	M12	200	5.30€
S63H4813	M13	200	6.30€
S63H4814	M14	200	6.40€

**S49H4**

Llave de vaso puntas XZN de 1/2"

Ref.	Medida	Longitud (mm)	Precio
S49H4105	M5	55	2.80€
S49H4106	M6	55	2.80€
S49H4108	M8	55	2.80€
S49H4110	M10	55	2.80€
S49H4112	M12	55	3.00€
S49H4114	M14	55	3.40€
S49H4116	M16	55	5.00€
S49H4308	M8	100	4.10€
S49H4310	M10	100	4.20€
S49H4312	M12	100	4.20€
S49H4314	M14	100	5.30€
S49H4318	M18	100	8.30€

**S64H4**

Llave de vaso puntas XZN de 1/2"

Ref.	Medida	Longitud (mm)	Precio
S64H4107	M7	55	2.10€
S64H4109	M9	55	2.10€
S64H4113	M13	55	3.00€
S64H4205	M5	100	2.60€
S64H4206	M6	100	2.60€
S64H4209	M9	100	2.60€
S64H4210	M10	100	2.60€
S64H4705	M5	140	3.20€
S64H4706	M6	140	3.20€
S64H4708	M8	140	3.20€
S64H4709	M9	140	3.20€
S64H4710	M10	140	3.20€
S64H4712	M12	140	3.90€
S64H4714	M14	140	4.70€
S64H4808	M8	200	4.00€
S64H4810	M10	200	4.00€
S64H4812	M12	200	5.00€
S64H4814	M14	200	5.90€

**C-DMH**

Barra magnética para llaves de vaso

Ref.	Medida	Capacid. (llaves)	Precio
C-DMH212	1/4"	12	14.50€
C-DMH314	3/8"	14	22.30€
C-DMH414	1/2"	12	23.20€

**MSH**

Tira de soporte para llaves de vaso

Ref.	Medida	Capacid. (llaves)	Precio
MSH1214	1/2"	14	2.00€
MSH1414	1/4"	14	1.60€
MSH3814	3/8"	14	1.90€

**S15H**

Cardán

Ref.	Medida	D1 (mm)	D2 (mm)	L (mm)	Precio
S15H240	1/4"	14	14	35	2.30€
S15H356	3/8"	18	18	49	3.60€
S15H472	1/2"	25	25	69	4.50€
S15H6109	3/4"	39,7	39,5	106,2	22.00€



**S16H**

Adaptador

Ref.	Medida	A (mm)	D1 (mm)	D2 (mm)	L (mm)	Precio
S16H1234	1/2" F - 3/4" M	19	12,7	27	45	3.30€
S16H1238	1/2" F - 3/8" M	9,52	12,7	22	34	1.20€
S16H1438	1/4" F - 3/8" M	9,52	6,35	14	25	1.00€
S16H3410	3/4" F - 1" M	25,3	19,05	39,7	59,6	9.50€
S16H3412	3/4" F - 1/2" M	12,7	19,05	35	51	5.10€
S16H3812	3/8" F - 1/2" M	12,7	9,52	17	35	1.20€
S16H3814	3/8" F - 1/4" M	6,35	9,75	18,6	28	1.00€



**S16H**

Adaptador

Ref.	Medida	A (mm)	D1 (mm)	D2 (mm)	L (mm)	Precio
S16H302	1/4" M - 3/8" F	6,35	9,75	18,6	28	2.00€
S16H304	1/2" M - 3/8" F	12,7	9,75	23,5	43,7	3.00€
S16H403	3/8" M - 1/2" F	9,5	12,9	23,5	40	3.00€



**S17H**

Llave de vaso bujias

Ref.	Medida	A (mm)	D1 (mm)	D2 (mm)	L (mm)	Precio
S17H3116	3/8"	9,525	21,7	18,8	65	1.50€
S17H3121	3/8"	9,525	27,6	21,5	65	2.00€
S17H4116	1/2"	12,7	21,8	21,8	65	1.50€
S17H4121	1/2"	12,7	27,6	23,6	65	2.10€

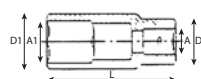

**S17H3414**



4.90€

Llave de vaso bujias 12 caras 1/2"

Medida: 14mm

**S21H**

Extensor



Ref.	Boquilla	Medida (mm)	Precio
S21H4150	1/2"	50	3.00€
S21H4175	1/2"	75	3.20€
S21H41125	1/2"	125	4.20€
S21H41250	1/2"	250	6.20€



**S22H**

**Mango articulado**

Ref.	Boquilla	Medida (mm)	Precio
S22H31200	3/8"	200	6.60€
S22H41375	1/2"	375	13.00€
S22H41450	1/2"	450	17.00€

**S22H41375RK**
**2.90€**

Kit de reparación para mango articulado S22H41375

**S22H41450RK**
**3.20€**

Kit de reparación para mango articulado S22H41450

**S22H**

**Mango articulado**

Ref.	Boquilla	Medida (mm)	Precio
S22H41600	1/2"	600	21.00€
S22H6500	3/4"	500	29.00€

**S22H41600RK**
**7.60€**

Kit de reparación para mango articulado S22H41600

**S22H6500RK**
**11.10€**

Kit de reparación para mango articulado S22H6500

**S23H**

**Cable en "T" corredizo**

Ref.	Boquilla	Medida (mm)	Precio
S23H21115	1/4"	115	2.50€
S23H31200	3/8"	200	4.20€
S23H41250	1/2"	250	5.10€
S23H41300	1/2"	300	6.00€
S23H6450	3/4"	450	16.80€
S23H6500	3/4"	500	18.00€
S23H8550	1"	550	36.50€

**S24H**

**Extensores**

Ref.	Boquilla	Medida (mm)	Precio
S24H250	1/4"	50	1.10€
S24H375	3/8"	75	1.55€
S24H450	1/2"	50	2.30€
S24H475	1/2"	75	2.70€
S24H2100	1/4"	100	1.20€
S24H2150	1/4"	150	1.40€
S24H3150	3/8"	150	2.30€
S24H3200	3/8"	200	2.60€
S24H4125	1/2"	125	3.20€
S24H4250	1/2"	250	4.00€
S24H6100	3/4"	100	8.00€
S24H6200	3/4"	200	10.80€
S24H6400	3/4"	400	19.00€

**S27H**

**Extensores flexibles**

Ref.	Boquilla	Medida (mm)	Precio
S27H2	1/4"	145	2.10€
S27H3	3/8"	193	16.40€
S27H4	1/4"	205	16.30€

**S42M**

**Extensores magnéticos**

Ref.	Boquilla	Medida (mm)	Precio
S42M475	1/2"	75	8.20€
S42M4125	1/2"	125	8.50€
S42M4250	1/2"	250	11.50€

**S42M403S**
**26.00€**
**Juego de 3 extensores magnéticos 1/2"**

Composición/ medidas en mm:

75; 125 y 250



**S60H4304S**

36.00€

Juego de 4 extensores de 1/2"

Composición/ medidas en mm:  
75; 125; 250 y 375



**S26H2150**

2.50€

Mango de 1/4"



**S26H2280**

11.50€

Mango 1/4" doble función fijado/ cardán



**S40T109S**

144.00€

Juego de 9 piezas "T" flexibles

Composición/ medidas en mm:  
8; 10; 12; 13; 14; 17 y 19  
Guiones P/T



**S41H41**

10.30€

Manivela cuadradillo macho de 1/2"



**S43H210**

19.30€

Extensor articulada en "T" con 1/2"; 3/8" y 1/4"



**R53A**

15.80€

Cable "T" con punta flexible

Medidas:  
Boquilla: 3/8"  
Longitud: 340mm



**R53A-3**

Adaptador "macho/macho"

Para aplicación en combinación con el cable flexible T de R53A

Precio

Ref.	Boquilla	Longitud (mm)	Precio
R53A-3A	3/8"	30	1.40€
R53A-4A	1/2"	35	1.90€



**S44H2206**

0.90€

Porta puntas 1/4"

Boquilla de 1/4" para uso en puntas de la broca de 1/4"



**S44H3110A**

2.50€

Porta puntas

Boquilla: 3/8"  
Utilización en puntas: 3/8"



**S44H4110**

2.00€

Porta puntas

Boquilla: 1/2"  
Utilización en puntas: 3/8"



**R19H3**

Llaves pie de gallo 3/8"



Ref.	Medida (mm)	Precio
R19H3110	10	3.50€
R19H3111	11	3.50€
R19H3112	12	3.60€
R19H3113	13	3.60€
R19H3114	14	3.60€
R19H3115	15	3.60€
R19H3116	16	3.60€
R19H3117	17	3.80€
R19H3118	18	3.80€
R19H3119	19	3.90€

**R19H310S**

36.50€

Juego de 10 llaves pie de gallo de 3/8"

Composición/ medidas em mm:

Llaves: 10; 11; 12; 13; 14; 15; 16; 17; 18 y 19

**S03A4111S**

33.20€

Juego de 11 llaves de impacto de 1/2"

Composición/ medidas (mm):

**S03A4** Llaves: 10; 11; 12; 13; 14; 16; 17; 19; 21; 22 y 24

**S03A4**

Llave impacto 1/2"

Ref.	Medida (mm)	D1 (mm)	D2 (mm)	L (mm)	Precio
S03A4109	9	15	24	38	2.60€
S03A4110	10	17	24	38	2.60€
S03A4111	11	19	24	38	2.60€
S03A4112	12	20	24	38	2.60€
S03A4113	13	20,8	24	38	2.60€
S03A4114	14	22	24	38	2.70€
S03A4115	15	24	24	38	2.70€
S03A4116	16	24	24	38	2.90€
S03A4117	17	26	26	38	3.10€
S03A4118	18	26	27	38	3.20€
S03A4119	19	28	28	38	3.30€
S03A4121	21	30	30	38	3.40€
S03A4122	22	32	30	38	3.70€
S03A4123	23	34	30	38	4.00€
S03A4124	24	34	30	43	4.10€
S03A4127	27	38	30	43	6.00€
S03A4129	29	40	30	48	6.50€
S03A4130	30	42	30	48	6.50€
S03A4132	32	44,6	30	48	7.00€

**S01U41**

Cardan de impacto 1/2"



Ref.	Medida (mm)	Longitud (mm)	Precio
S01U4113	13	70	10.30€
S01U4114	14	70	10.40€
S01U4115	15	70	10.50€
S01U4116	16	70	10.60€
S01U4117	17	70	11.00€
S01U4119	19	70	11.30€
S01U4121	21	70	11.70€
S01U4122	22	70	12.20€

**S01U4108S**

85.40€

Juego 8 llaves/ cardáns impacto 1/2"

Composición/ medidas em mm:

 Llaves: 13; 14; 15; 16;  
17; 19; 21 y 22

**S03A2**

Llave de impacto 1/4"



Ref.	Boquilla	Medida (mm)	Precio
S03A2110	1/4"	10	1.40€
S03A2112	1/4"	12	1.50€
S03A2114	1/4"	14	1.60€

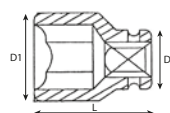

**S03AD4**

Llave impacto larga 1/2"



Ref.	Medida (mm)	D1 (mm)	D2 (mm)	L (mm)	Precio
S03AD4110	10	17	24	78	4.30€
S03AD4111	11	19	24	78	4.30€
S03AD4112	12	19,6	24	78	4.40€
S03AD4113	13	20,8	24	78	4.40€
S03AD4114	14	22	24	78	4.50€
S03AD4115	15	24	24	78	4.50€
S03AD4116	16	24	24	78	4.50€
S03AD4117	17	26	26	78	4.70€
S03AD4118	18	28	27	78	4.90€
S03AD4119	19	28	28	78	5.00€
S03AD4121	21	30	30	78	5.50€
S03AD4122	22	32	30	78	5.80€
S03AD4124	24	34,6	30	78	6.60€
S03AD4126	26	37	30	78	7.80€
S03AD4127	27	38	30	78	8.20€
S03AD4128	28	39,5	30	78	8.40€
S03AD4130	30	42	30	78	9.80€
S03AD4132	32	44,6	30	78	10.50€



**S03AD4111S**

49.00€

Juego de 11 llaves de impacto largas de 1/2"

Composición/ medidas (mm):

S03AD4 Llaves: 10; 11; 12; 13; 14; 16; 17; 19; 21; 22 y 24



**S03A4A**

Adaptador de 1/2"



Ref.	Boquilla	Precio
S03A4A3	3/8"	4.00€
S03A4A6	3/4"	5.50€

**S03A4U4**

Cardán de 1/2"



9.90€

**S03A4UT3S**

25.50€

Juego de 3 cardáns impacto

Composición/ medidas:

1/4"; 3/8" y 1/2"



**S03A4E**

Extensor



Ref.	Boquilla	Medida (mm)	Precio
S03A4E4	1/2"	100	4.90€
S03A4E5	1/2"	125	4.70€
S03A4E6	1/2"	150	6.00€
S03A4E8	1/2"	200	7.10€

**S03A4211S**

35.00€

Juego de 11 llaves impacto 1/2" SAE

Composición:

Ref.	Medida	Ref.	Medida
S03A4210	3/8"	S03AD4219	3/4"
S03A4211	7/16"	S03AD4221	13/16"
S03A4213	1/2"	S03AD4222	7/8"
S03A4214	9/16"	S03AD4224	15/16"
S03A4216	5/8"	S03AD4226	1"
S03A4217	11/16"		



**S03AD4414S**

82.00€

Juego de 14 llaves largas impacto 1/2" SAE

Composición/ medidas:

Llaves: 3/8"; 7/16"; 1/2"; 9/16"; 5/8"; 11/16"; 3/4"; 13/16"; 7/8"; 15/16"; 1"; 1-1/16"; 1-1/8" y 1-1/4"

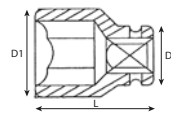

**S03A6**
**Llave impacto 3/4"**

Ref.	Medida (mm)	D1 (mm)	D2 (mm)	L (mm)	Precio
S03A6126	26	41	38	51	6.70€
S03A6127	27	43	40	53	6.80€
S03A6129	29	45	42	53	7.40€
S03A6130	30	46	44	53	7.80€
S03A6132	32	49	44	57	8.40€
S03A6133	33	51	44	57	9.00€
S03A6134	34	51	44	57	9.20€
S03A6135	35	53	44	57	9.90€
S03A6136	36	54	44	57	10.20€
S03A6137	37	55	44	57	10.50€
S03A6138	38	56	44	57	10.80€
S03A6139	39	57,7	44	57	11.90€
S03A6140	40	59	44	57	12.90€
S03A6141	41	60	44	57	12.90€
S03A6142	42	61,4	44	57	15.50€
S03A6143	43	62,7	44	62	16.20€
S03A6144	44	64	44	62	17.50€
S03A6145	45	65	44	62	18.00€
S03A6146	46	66,4	44	62	18.20€
S03A6147	47	67,6	44	67	18.80€
S03A6148	48	68,8	44	67	19.40€
S03A6149	49	70	44	72	20.20€
S03A6150	50	71,4	72	72	22.20€
S03A6151	51	72,8	72	72	25.00€
S03A6152	52	74	72	72	25.90€
S03A6153	53	75	72	72	27.00€
S03A6154	54	76,4	72	72	27.50€
S03A6155	55	77,7	74	74	28.50€
S03A6156	56	79	74	74	31.50€
S03A6157	57	80	74	74	32.50€
S03A6158	58	81,5	75	75	35.50€
S03A6159	59	82,7	75	75	36.50€
S03A6160	60	84	75	75	39.00€
S03A6163	63	87,6	75	75	41.00€
S03A6165	65	90	78	78	43.50€
S03A6167	67	92,7	80	80	48.00€
S03A6170	70	96,4	83	83	55.00€

**S03A6108S**
**65.50€**
**Juego de 8 llaves de impacto de 3/4"**

Composición/ medidas:

**S03A6** Llaves: 26; 27; 29; 30; 32; 35; 36 y 38

**S03AD6**

Llave impacto larga 3/4"

Ref.	Medida (mm)	D1 (mm)	D2 (mm)	L (mm)	Precio
S03AD6126	26	41,3	44	90	14.70€
S03AD6127	27	42,6	44	90	14.70€
S03AD6129	29	45,1	44	90	15.00€
S03AD6130	30	46,4	44	90	15.00€
S03AD6132	32	48,9	44	90	15.40€
S03AD6133	33	50,6	44	90	15.40€
S03AD6134	34	51,4	44	90	16.20€
S03AD6135	35	52,7	44	90	16.50€
S03AD6136	36	53,9	44	90	17.30€
S03AD6138	38	56,4	44	90	18.50€
S03AD6140	40	58,9	44	90	22.00€
S03AD6141	41	60,1	44	90	23.20€
S03AD6142	42	61,4	44	90	24.90€
S03AD6146	46	66,4	44	90	29.80€
S03AD6150	50	71,4	54	90	34.00€



**S03AD6107S**

107.00€

Juego de 7 llaves de impacto largas de 3/4"

Composición/ medidas:

S03AD6 Llaves: 26; 27; 29;  
32; 35; 36 y 38



**S03AD6120S**

252.00€

Juego de 20 piezas de impacto de 3/4"

Composición/ medidas en mm:

S03AD6 Llaves: 24; 27; 30; 32; 33; 34; 35; 36; 41 y 46

S03A6A4 Adaptador 3/4" - 1/2"

S03A6A8 Adaptador 3/4" - 1"

S03A6U6 Cardán 3/4"

S03A6E Extensor de 3/4" 250 mm

Pernos

Anillos de goma



**S03A6A**

Adaptador de 3/4"

Ref.	Boquilla	Precio
S03A6A4	1/2"	10.00€
S03A6A8	1"	12.00€



**S03A6U6**

Cardán de 3/4"

34.00€



**S03A6E**

Extensión

Ref.	Boquilla	Medida (mm)	Precio
S03A6E04	3/4"	100	17.00€
S03A6E08	3/4"	200	22.00€
S03A6E10	3/4"	250	24.00€

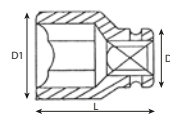

**S03A8**
**Llave impacto 1"**

Ref.	Medida (mm)	D1 (mm)	D2 (mm)	L (mm)	Precio
S03A8124	24	41,9	54	58	16.00€
S03A8127	27	45,6	54	58	16.00€
S03A8129	29	48,1	54	60	16.20€
S03A8130	30	49,4	54	60	16.20€
S03A8132	32	51,9	54	60	16.30€
S03A8133	33	53,6	54	60	16.50€
S03A8134	34	54,4	54	62	17.00€
S03A8135	35	55,7	54	62	17.50€
S03A8136	36	56,9	54	62	17.50€
S03A8138	38	59,4	54	65	18.00€
S03A8140	40	110	15		19.00€
S03A8141	41	63,1	54	65	19.00€
S03A8144	44	120	15		23.00€
S03A8146	46	69,4	54	74	24.00€
S03A8150	50	74,4	54	74	29.50€
S03A8155	55	80,7	54	85	36.00€
S03A8160	60	87,1	54	90	46.50€
S03A8165	65	93,2	54	90	55.00€
S03A8170	70	99,4	54	100	70.00€
S03A8173	73	103,3	86	100	82.00€
S03A8175	75	105,6	86	100	92.00€
S03A8176	76	106,9	86	100	103.00€
S03A8178	78	110	86	100	108.00€
S03A8180	80	111,9	86	100	114.00€
S03A8185	85	118,5	86	110	138.00€
S03A8189	89	123,2	86	110	140.00€
S03A8190	90	124,4	86	110	158.00€
S03A8192	92	126,8	86	110	165.00€
S03A8195	95	129	86	110	183.00€

**S03A8109S**
**163.00€**
**Juego de 9 llaves impacto 1"**

Composición/ medidas:

**S03A8** Llaves: 24; 27; 30; 32; 35; 38; 41; 46 y 50

**S03A8A6**
**Adaptador 1" - 3/4"**

**16.70€**
**S03A8E**
**Extensor impacto**

Ref.	Boquilla	Medida (mm)	Precio
S03A8E04	1"	100	25.00€
S03A8E07	1"	175	31.00€
S03A8E10	1"	250	47.00€

**S03AD8107S**
**165.00€**
**Juego de 7 llaves largas de impacto 1"**

Composición/ medidas:

**S03AD8** Llaves: H5, H6, H8, H10, H12, H14, H17 y H19  
Maleta en metal

**S03AD8**

Llave impacto larga 1"

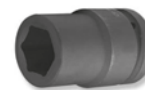

Ref.	Medida (mm)	D1 (mm)	D2 (mm)	L (mm)	Precio
S03AD8117	17	33,1	54	90	21.00€
S03AD8124	24	41,9	54	90	22.00€
S03AD8126	26	43,3	54	90	22.00€
S03AD8127	27	45,6	54	90	22.10€
S03AD8129	29	48,1	54	90	22.10€
S03AD8130	30	49,4	54	90	22.10€
S03AD8132	32	51,9	54	90	22.50€
S03AD8133	33	53,6	54	90	22.60€
S03AD8134	34	54,4	54	90	22.70€
S03AD8135	35	55,7	54	90	23.50€
S03AD8136	36	56,9	54	90	23.80€
S03AD8138	38	59,4	54	90	25.50€
S03AD8140	40	61,9	54	90	27.20€
S03AD8141	41	63,1	54	90	28.00€
S03AD8142	42	64,4	54	90	28.80€
S03AD8146	46	69,4	54	90	35.00€
S03AD8148	48	71,8	54	90	37.00€
S03AD8150	50	74,4	54	90	42.50€
S03AD8155	55	80,7	54	90	53.00€
S03AD8158	58	84,5	54	105	58.00€
S03AD8160	60	87,1	54	120	67.00€
S03AD8165	65	93,2	54	120	75.00€



**S03S8**

Llave de impacto



Ref.	Boquilla	Medida (mm)	Precio
S03S8117	1"	17	16.00€
S03S8119	1"	19	16.50€
S03S8121	1"	21	17.00€

**S03SD8**

Llave de impacto



Ref.	Boquilla	Medida (mm)	Precio
S03SD8117	1"	17	21.50€
S03SD8119	1"	19	22.00€
S03SD8121	1"	21	22.50€

**S05A4H**

Punta allen de impacto 1/2"

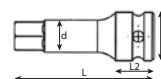

Ref.	Medida	D (mm)	d (mm)	L2 (mm)	L (mm)	Precio
S05A4H4	H4	25	6	22,5	78	7.80€
S05A4H5	H5	25	7	22,5	78	8.00€
S05A4H6	H6	25	8	22,5	78	8.00€
S05A4H8	H8	25	10,5	22,5	78	8.00€
S05A4H10	H10	25	12,5	22,5	78	8.50€
S05A4H12	H12	25	15	22,5	78	8.50€
S05A4H14	H14	25	17,5	22,5	78	8.50€
S05A4H17	H17	25	21	22,5	78	8.50€
S05A4H18	H18	25	22	22,5	78	8.50€
S05A4H19	H19	25	23	22,5	78	8.50€



**S05A408S**

62.00€

Juego de 8 llaves de vaso con punta macho hexagonal de impacto 1/2"

Composición:

S05A4 Llaves: H5; H6; H8; h10; H12; H14; H17 y H19

**S06A4T**

Llaves de vaso con punta macho torx de impacto de 1/2"

Ref.	Medida	Precio
S06A4T20	T20	8.00€
S06A4T27	T27	8.00€
S06A4T30	T30	8.00€
S06A4T40	T40	8.00€
S06A4T45	T45	8.00€
S06A4T50	T50	8.00€
S06A4T55	T55	8.10€
S06A4T60	T60	8.10€
S06A4T70	T70	8.10€
S06A4T80	T80	8.10€

**S06A408S**

58.00€

Juego de 8 llaves vaso con punta macho torx de impacto 1/2"

Composición:

S06A4 Llaves: T30; T40; T45; T50; T55; T60; T70 y T80

**S12A4525S**

181.00€

Juego de 25 llaves impacto magnéticas de 1/2"

Composición:

 Llaves de 1/2": 3/8"; 7/16"; 1/2"; 9/16"; 5/8"; 11/16"; 3/4"; 13/16"; 7/8"; 15/16" y 1"  
 Llaves de 1/2": 10 a 21mm  
 Cardán de 1/2"  
 Extensión 80mm

**S18A4117M**

15.10€

Llave impacto magnética de 17 mm de 1/2"

**S18A4119M**

15.20€

Llave impacto magnética de 19 mm de 1/2"

**S18A4121M**

15.50€

Llave impacto magnética de 21 mm de 1/2"

**S18A4103MS**

48.50€

Juego de 3 llaves impacto magnéticas de 1/2"

Composición:

Llaves: 17; 19 y 21mm

**S03AD4317**

7.00€

Llave impacto de 17 mm de 1/2"

**S03AD4319**

7.20€

Llave impacto de 19 mm de 1/2"

**S03AD4321**

7.30€

Llave impacto de 21 mm de 1/2"

**S03AD4303S**

23.50€

Juego de 3 llaves impacto de 1/2"

Composición:

Ref.	Medida (mm)
S03AD4317	17
S03AD4319	19
S03AD4321	21



**S03AD4307S**

68.00€

Juego de 7 llaves impacto de 1/2"

Composición:

Ref.	Medida (mm)	Ref.	Medida (mm)
S03AD4317	17	S03AD4323	23
S03AD4319	19	S03AD4324	24
S03AD4321	21	S03AD4327	27
S03AD4322	22		



**S03AD4517**

16.30€

Llave impacto larga de 17 mm de 1/2"



**S03AD4519**

16.50€

Llave impacto larga de 19 mm de 1/2"



**S03AD4521**

17.00€

Llave impacto larga de 21 mm de 1/2"



**S03AD4503S**

57.00€

Juego de 3 llaves impacto larga de 1/2"

Composición:

Ref.	Medida (mm)	Longitud (mm)
S03AD4517	17	150
S03AD4519	19	150
S03AD4521	21	150



**S18A41**

Llave impacto larga para ruedas



Ref.	Boquilla	Medida (mm)	D (mm)	L (mm)	Color	Precio
S18A4115	1/2"	15	25	85	Naranja	6.00€
S18A4117	1/2"	17	27	85	Azul	7.30€
S18A4119	1/2"	19	28,5	85	Verde	7.50€
S18A4121	1/2"	21	31	85	Rojo	7.70€

**S18AD41**

Llave impacto extra larga para ruedas



Ref.	Boquilla	Medida (mm)	D (mm)	L (mm)	Color	Precio
S18AD4117	1/2"	17	27	150	Azul	16.00€
S18AD4119	1/2"	19	28,5	150	Verde	16.30€
S18AD4121	1/2"	21	31	150	Rojo	16.50€

**S46TE80**

14.00€

Barra de presión 110Nm de 1/2"

Longitud: 196mm

Color: azul



**P018** 14.40€

Alicate universal  
Longitud: 200mm



**P038** 10.50€

Alicate de corte diagonal  
Longitud: 200mm



**P046** 9.30€

Alicate de corte  
Longitud: 160mm



**P068** 11.20€

Alicate de puntas  
Longitud: 200mm  
Capacidad máxima: Ø3,0mm



**P068A** 9.50€

Alicate de puntas  
Longitud: 200mm



**P079** 16.70€

Alicate universal  
Longitud: 200mm  
Capacidad máxima: Ø3,0mm



**P6008** 7.80€

Alicate regulable (2 posiciones)  
Longitud: 200mm



**P61**

Alicate de corte frontal

Ref.	Longitud (mm)	Precio
<b>P6106</b>	160	9.20€
<b>P6108</b>	200	10.90€



**P9506** 13.50€

Alicate cortafrios  
Longitud: 165mm  
Peso: 188g



## Alicates

con revestimiento antideslizante

**P27**

Alicate ajustable

Ref.	Longitud (mm)	Precio
<b>P2706</b>	160	9.90€
<b>P2710</b>	250	12.20€
<b>P2712</b>	330	20.00€



**P2810**

Alicate ajustable  
Longitud: 250mm

12.70€



**AG01000**

Alicate de clips interiores (puntas rectas)

Ref.	Longitud (mm)	Precio
<b>AG010002</b>	175	9.10€
<b>AG010003</b>	230	13.00€



**AG01000**

Alicate de clips interiores (puntas curvas)

Ref.	Longitud (mm)	Precio
<b>AG010005</b>	175	9.20€
<b>AG010006</b>	230	13.60€



**AG01000**

Alicate de clips exteriores (puntas rectas)

Ref.	Longitud (mm)	Precio
<b>AG010008</b>	175	9.20€
<b>AG010009</b>	230	13.00€



**AG01000**

Alicate de clips exteriores (puntas curvas 90°)

Ref.	Longitud (mm)	Precio
<b>AG010011</b>	175	9.50€
<b>AG010012</b>	230	13.00€



## Alicates

### con muelle

**P7101**

14.50€

Mini alicata de puntas curvas 45° (diseño ergonómico)

Longitud: 140mm

Peso: 90g



**P7102**

13.70€

Mini alicata de corte frontal (diseño ergonómico)

Longitud: 110mm

Peso: 90g



**P7103**

13.00€

Mini alicata de corte diagonal (diseño ergonómico)

Longitud: 115mm

Peso: 90g



**P7104**

13.00€

Mini alicata universal (diseño ergonómico)

Longitud: 120mm

Peso: 90g



**P7105**

13.00€

Mini alicata de puntas rectas (diseño ergonómico)

Longitud: 135mm

Peso: 90g



**P8006**

15.80€

Alicata universal

Longitud: 160mm



**P8106**

15.90€

Alicata puntas largas

Longitud: 160mm



**P8606**

16.30€

Alicata de corte diagonal

Longitud: 160mm



**P9006**

15.50€

Alicata puntas planas

Longitud: 160mm







Símbolo				
Tipo de material	Suave	Dureza média	Duro	Cuerda de piano
Ejemplo	Cobre, aluminio	Hierro	Acero	Acero duro/ resorte
Tensión N/mm <sup>2</sup>	220-250	750-800	1700-1800	2200-2300





**P051**
**Alicate corta cables**

Ref.	Longitud (mm)	Precio
<b>P0516</b>	160	12.70€
<b>P0518</b>	200	15.30€





**P081**
**Alicate universal**

Ref.	Longitud (mm)					Precio
<b>P0816</b>	160					10.10€
<b>P0817</b>	180					10.30€
<b>P0818</b>	200					14.00€



**P091**
**Alicate de corte (trabajo intenso)**

Ref.	Longitud (mm)					Precio
<b>P0916</b>	160					12.50€
<b>P0918</b>	200					13.50€





**P101**
**Alicate de corte**

Ref.	Longitud (mm)					Precio
<b>P1016</b>	160					11.50€
<b>P1017</b>	180					12.70€

**P111**
**Alicate de puntas**

Ref.	Longitud (mm)					Precio
<b>P1116</b>	160					10.40€
<b>P1118</b>	200					12.50€

**P121**
**Alicate de puntas curvas**

Ref.	Longitud (mm)					Precio
<b>P1216</b>	160					10.80€
<b>P1218</b>	200					13.40€

**P1416**
**Alicate de puntas planas**

Longitud: 160mm

10.20€

**P1516**
**Alicate de pelar**

Longitud: 160mm

11.10€

**P4016**
**Alicate de puntas redondas**

Longitud: 160mm

10.90€

**P6116**
**Alicate de corte frontal**

Ref.	Longitud (mm)					Precio
<b>P6116</b>	160	4.0	3.0	2.0	1.6	11.90€

**P2811**
**Alicate ajustable**

Ref.	Longitud (mm)	Precio
<b>P28110</b>	240	15.50€
<b>P28112</b>	300	23.30€

**P2821**
**Alicate ajustable**

Ref.	Longitud (mm)	Precio
<b>P28210</b>	240	21.20€
<b>P28212</b>	300	29.30€



## Alicates

### con muelle

**P178**

Tenazas de carpintero

Longitud: 200mm



13.20€

**P1810**

Tenazas de encofrado

Longitud: 250mm



13.40€

**P2010LA**

Tijera articulada

Corte izquierda

Longitud: 250mm

Peso: 395g

Capacidad de corte: Acero: 1,2mm | Acero inoxidable: 0,7mm



10.70€

**P2010RA**

Tijera articulada

Corte derecha

Longitud: 250mm

Peso: 395g

Capacidad de corte: Acero: 1,2mm | Acero inoxidable: 0,7mm



10.80€

**P2010SA**

Tijera articulada

Hojas rectas

Longitud: 200mm



10.80€

**P22**

Tijera de cortar chapa

Ref.

Longitud  
(mm)

Precio

**P2208A** 205 11.10€

**P2212A** 305 17.50€



**P2205E**

Tijera de electricista



10.50€

**P43**

Alicate corta cables

Ref.

Longitud  
(mm)

Peso

Capac.  
de corte

Precio

**P4318** 450 1 570g Fio 5mm 38.50€

Cabo 10mm

**P4330** 750 4 200g Fio 9mm 63.00€

Cabo 14mm



**P4318-RK**

Kit de reparación

17.80€

**P4330-RK**

Kit de reparación

36.80€

**P6424**

Alicate corta cables

Longitud: 600mm

Peso: 2 700g

Capacidad de corte: Ø 10mm



36.00€

**P7601**

Alicate largo de puntas rectas

Longitud: 275mm



17.00€

**P7602**

Alicate largo de puntas curvas 45°

Longitud: 275mm



16.50€

**P7603**

Alicate largo de puntas curvas 90°

Longitud: 275mm



16.50€

**P7608**

Alicate largo de puntas redondas Ø13mm

Longitud: 275mm



17.20€

**P7719**

Alicate largo de torcer alambre

Longitud: 270mm

Peso: 360g

Capacidad: Ø 0,55mm



31.80€

**V1001** 17.50€

Alicate de rebitar (trabajo intensivo)

Incluye 4 boquillas: 2,4; 3,2; 4 y 4,8mm



**V1002** 49.00€

Alicate de rebitar extensible

Incluye 4 boquillas: 2,4; 3,2; 4 y 4,8mm



**V1003** 35.00€

Remachadora (trabajo intensivo)

Incluye boquillas: 6,4; 3,2; 4 y 4,8mm



**V1005** 18.00€

Remachadora (boquillas intercambiables)

Incluye boquillas: 2,4; 3,2; 4 y 4,8mm



**V1103** 33.00€

Alicate de remaches hembra

Capacidad: M3; M4; M5 y M6



**V21**

Remachadora (boquillas intercambiables)

Ref.	Boquillas (mm)	Precio
V2101	2,4; 3,2; 4 y 4,8 mm	27.50€
V2102	3,2; 4; 4,8 y 6,4 mm	38.50€



**AR030058** 108.00€

Alicate de apriete de terminales

Intercambiable para 6 tipos de terminales



## Alicates

### aislantes

**V1310**

Alicate de engatillar terminales



Ref.	Características	Precio
V1310A	Terminales aislados	37.50€
V1310C	Clavijas de los cables coaxiales	36.00€
V1310E	Terminales no aislados	36.00€
V1310F	Clavijas RJ45	41.00€

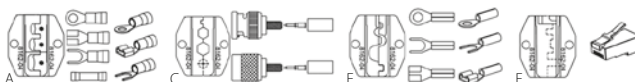

**V1310**

Accesorios para alicate engatillar terminales V1310

Ref.	Mordazas	Precio
V1310A-11	Mordazas	13.00€
V1310B-11	Mordazas	13.00€
V1310E-11	Mordazas	13.00€

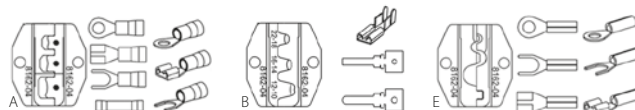

**V1401** 8.00€

Alicate de engatillar terminales/pelar hilos



**V1403** 14.50€

Alicate de engatillar (trabajo intensivo)



**V1501** 19.50€

Alicate de pelar (trabajo intensivo)

Tornillo de ajuste para alambres gruesos

Longitud: 172mm

Peso: 305g



**V1505** 16.00€

Alicate de pelar



## Alicates

### con revestimiento antideslizante

#### P30M10A

11.70€

Alicate de bloqueo boquillas rectas

Longitud: 250mm  
Peso: 540g



#### P32M

Alicate de bloqueo boquillas cóncavas

Ref.	Longitud (mm)	Precio
------	---------------	--------

P32M07A	180	9.60€
P32M10A	250	10.80€



#### P36M09A

9.90€

Alicate de bloqueo boquillas largas

Longitud: 230mm



#### P37M

Alicate de bloqueo cuello de cisne

Ref.	Longitud (mm)	Precio
------	---------------	--------

P37M11A	280	16.90€
P37M18A	450	29.00€



#### P38M

Alicate de bloqueo para soldadura

Ref.	Longitud (mm)	Precio
------	---------------	--------

P38M09A	230	14.00€
P38M11A	280	17.00€



#### P52M10

14.30€

Alicate de bloqueo boquillas curvas

Longitud: 250mm



#### P53M

Alicate cuello de cisne mandibula oscilante

Ref.	Longitud (mm)	Precio
------	---------------	--------

P53M06	152	10.70€
P53M11	280	18.70€
P53M18	460	30.00€



#### P54M

Alicate de bloqueo para hojalatero

Ref.	Longitud (mm)	Precio
------	---------------	--------

P54M08A	205	12.50€
P54M10A	250	15.70€



#### P52N10

16.80€

Alicate de bloqueo boca larga

Longitud: 240mm



#### P1019

16.00€

Alicate de bloqueo con corriente

Longitud: 230mm  
Capacidad: 457mm



#### P9409

14.50€

Alicate de bloqueo



#### P30M07C

12.20€

Alicate de bloqueo aislado

Longitud: 175mm  
Peso: 360g



#### P32M

Alicate de bloqueo aislado con mordazas curvadas y corta cables

Ref.	Longitud (mm)	Peso (g)	Precio
------	---------------	----------	--------

P32M05C	125	175	10.70€
P32M10C	250	560	13.50€



#### P36M

Alicate de bloqueo aislante de boquillas largas con corta cables

Ref.	Longitud (mm)	Peso (g)	Precio
------	---------------	----------	--------

P36M06C	152	180	10.90€
P36M09C	270	560	12.80€





**P78M10C**

14.60€

Alicate de bloqueo aislado  
Longitud: 250mm



**P32M03S**

36.40€

Juego de 3 alicates de bloqueo

Ref.	Características	Longitud (mm)
P36M06S	Boquillas largas	160
P32M07S	Boquillas cóncavas	180
P32M10S	Boquillas cóncavas	250



**P7801**

21.30€

Alicate de bloqueo multifunción  
Garras tipo W



**Alicates**

con muelle

**P7802**

21.50€

Alicate de bloqueo multifunción  
Garras tipo JJ



**P7803**

21.50€

Alicate de bloqueo multifunción  
Garras tipo LL



**P7804**

20.20€

Alicate de bloqueo multifunción  
Garras tipo J



**P7805**

20.80€

Alicate de bloqueo multifunción

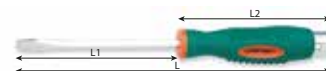

**D70S**
**Destornillador plano de impacto**

Ref.	Medida (mm)	L1 (mm)	L2 (mm)	L (mm)	Precio
D70S475	4	75	107	182	3.00€
D70S5100	5,5	100	107	207	3.80€
D70S6125	6,5	125	127	252	4.70€
D70S6150	6,5	150	127	277	5.10€
D70S8150	8	150	144	294	6.70€
D70S8175	8	175	144	319	7.00€
D70S9175	9,5	175	144	319	7.30€
D70S9250	9,5	250	144	394	8.50€

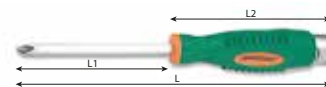
**D70P**
**Destornillador phillips de impacto**

Ref.	Medida	L1 (mm)	L2 (mm)	L (mm)	Precio
D70P175	PH1	75	107	182	3.80€
D70P2100	PH2	100	127	277	4.40€
D70P3125	PH3	125	144	269	6.75€
D70P3150	PH3	150	144	299	7.20€

**D70PP10S**
**55.00€**
**Juego de 10 destornillador plano/ phillips de impacto**

Composición/ medidas (mm):

D70S Destornillador plano: 5,5x100; 6,5x125; 8x150; 9,5x175 y 6,5x38

 D70P Destornillador phillips: PH1x75; PH2x100; PH3x125 y PH2x38  
 Puntero magnético

**DV13PP-TP**
**2.70€**
**Buscapolos**

220 - 250 v

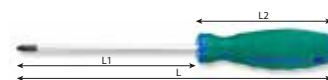

**D71P**
**Destornillador phillips**

Ref.	Medida	L1 (mm)	L2 (mm)	L (mm)	Precio
D71P060	PH0	60	90	150	2.20€
D71P138	PH1	38	56	94	2.10€
D71P180	PH1	80	110	190	2.40€
D71P238	PH2	38	56	94	2.10€
D71P1100	PH1	100	110	210	2.70€
D71P1150	PH1	150	110	250	2.90€
D71P1300	PH1	300	110	410	3.90€
D71P2100	PH2	100	119	219	3.00€
D71P2150	PH2	150	119	269	3.30€
D71P2250	PH2	250	119	369	4.90€
D71P2400	PH2	400	119	519	6.30€
D71P3150	PH3	150	129	279	4.20€
D71P3250	PH3	250	129	279	6.50€
D71P3400	PH3	400	129	529	8.30€
D71P4200	PH4	200	129	329	5.60€

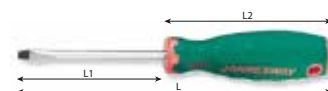
**D71S**
**Destornillador plano**

Ref.	Medida (mm)	L1 (mm)	L2 (mm)	L (mm)	Precio
D71S250	2,4	50	72	122	1.85€
D71S360	3	60	72	132	2.00€
D71S4100	4	100	90	190	2.20€
D71S4200	4	200	90	290	3.40€
D71S480	4	80	90	170	2.10€
D71S5125	5,5	125	110	235	2.50€
D71S5200	5,5	200	110	310	3.10€
D71S5300	5,5	300	110	410	4.30€
D71S538	5,5	38	56	94	2.30€
D71S575	5,5	75	110	185	2.40€
D71S638	6,5	38	56	94	2.10€
D71S6100	6,5	100	119	219	3.10€
D71S6150	6,5	150	119	269	3.30€
D71S6400	6,5	400	119	519	6.20€
D71S8150	8	150	129	279	4.20€
D71S8200	4	200	129	329	5.00€
D71S8300	8	300	129	429	6.00€
D71S8500	8	500	129	629	9.00€
D71S9175	9,5	175	129	304	4.60€
D71S10250	10	250			5.70€

## Destornilladores

### D71T

#### Destornillador torx

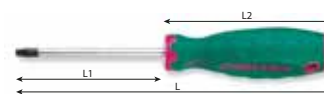

Ref.	Medida	L1 (mm)	L2 (mm)	L (mm)	Precio
D71T5	T5	60	73	132	2.00€
D71T6	T6	60	73	132	2.00€
D71T7	T7	60	73	132	2.00€
D71T8	T8	60	73	132	2.00€
D71T9	T9	60	73	132	2.00€
D71T10	T10	80	90	170	2.10€
D71T15	T15	80	90	170	2.10€
D71T20	T20	100	110	210	2.50€
D71T25	T25	100	110	210	2.50€
D71T27	T27	100	119	219	3.30€
D71T30	T30	125	119	244	3.50€
D71T40	T40	150	129	279	4.60€
D71T45	T45	200	129	329	4.70€
D71T50	T50	200	129	329	5.50€

### D71400T

#### Destornillador torx largo



Ref.	Medida	Longitud (mm)	Precio
D71400T10	T10	400	5.50€
D71400T15	T15	400	5.80€
D71400T20	T20	400	6.20€
D71400T25	T25	400	6.50€
D71400T30	T30	400	7.80€

### D71Z

#### Destornillador pozi

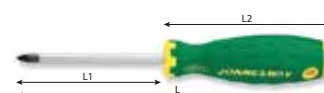

Ref.	Medida	L1 (mm)	L2 (mm)	L (mm)	Precio
D71Z060	PZ0	60	90	150	2.10€
D71Z138	PZ1	38	56	94	2.20€
D71Z180	PZ1	80	110	190	2.50€
D71Z2100	PZ2	100	119	219	3.00€
D71Z3150	PZ3	150	129	279	4.50€
D71Z4200	PZ4	200	129	329	5.10€

### D725N

#### Llaves T con mango antideslizante con vaso hexagonal



Ref.	Medida (mm)	Longitud (mm)	Precio
D725N06	6	298	6.00€
D725N07	7	298	6.10€
D725N08	8	298	6.20€
D725N09	9	298	6.30€
D725N10	10	298	6.40€
D725N11	11	298	6.50€
D725N12	12	298	6.70€
D725N13	13	298	6.90€

**D715N**

Destornilladores de vaso con mango



Ref.	Medida	L1 (mm)	L2 (mm)	L (mm)	Precio
D715N05	5	125	119	244	4.40€
D715N08	8	125	119	244	4.70€
D715N10	10	125	119	244	4.90€
D715N12	12	125	119	244	5.10€
D715N13	13	125	119	244	5.50€

**D71C105S**

16.00€

Juego de 5 destornilladores plano/ phillips

Composición/ medidas (mm):

**D71S** Destornilladores plano: 4x80; 5,5x125 y 6,5x150

**D71P** Destornilladores phillips: PH1x80 y PH2x100

**D71C106S**

17.00€

Juego de 6 destornilladores plano/ phillips

Composición/ medidas (mm):

Destornilladores plano: 6x60; 5,5x125 y 6,5x150

Destornilladores phillips: PH0x60; PH1x80 y PH2x100

**D71PP08S**

29.20€

Juego de 8 destornilladores plano/ phillips con mango antideslizante

Composición/ medidas (mm):

**D71S** Destornilladores plano: 6,5x38; 4x80; 5,5x125 y 6,5x150

**D71P** Destornilladores phillips: PH2x38; PH1x80; PH2x100 y PH3x150

**D71PP16S**

63.00€

Juego de 16 destornilladores plano/ phillips con mango antideslizante

Composición/ medidas (mm):

**D71S** Destornilladores plano: 6,5x38; 3x50; 6,5x100; 5,5x125; 5,5x200; 8,5x150; 5,5x75 y 4x150

**D71P** Destornilladores phillips: PH2x38; PH1x150; PH0x60; PH1x80; PH2x100; PH2x150; PH3x150 y PH1x38

**D71T107S**

22.00€

Juego de 7 destornilladores torx con mango antideslizante

Composición/ medidas (mm):

Destornilladores: T10; T15; T20; T25; T27; T30 y T40

**D71T109S**

26.00€

Juego de 9 destornilladores torx con mango antideslizante

Composición/ medidas (mm):

Destornilladores: T8; T9; T10; T15; T20; T25; T27; T30 y T40

**D71Z105S**

17.00€

Juego de 5 destornilladores plano/ pozi

Composición/ medidas (mm):

Destornilladores plano: 4x80; 5,5x125 y 6,5x150

Destornilladores pozi: PZ1x80 y PZ2x100



**D71Z107S**

26.00€

Juego de 7 destornilladores plano/ pozi con mango antideslizante

Composición/ medidas (mm):

Destornilladores plano: 4x100; 5,5x125; 6,5x150 y 8x175  
Destornilladores pozi: PZ1x80; PZ2x100 y PZ3x150



**D3750P08S**

17.00€

Juego de 8 destornilladores de precisión plano/ phillips

Composición:

Ref.	Destornill.	Punta (mm)	Longitud (mm)
D3750S30	fenda	3	50
D3750S24	fenda	2,4	50
D3750S20	fenda	2	50
D3750S16	fenda	1,6	50
D3750S10	fenda	1	50
D3750P1	phillips	nº1	50
D3750P0	phillips	nº0	50
D3750P00	phillips	nº00	50



**D3750T08S**

17.00€

Juego de 8 destornilladores de precisión torx

Composición:

Ref.	Medida (mm)	Ref.	Medida (mm)
D3750T20	T20x50	D3750T8	T8x50
D3750T15	T15x50	D3750T7	T7x50
D3750T10	T10x50	D3750T6	T6x50
D3750T9	T9x50	D3750T5	T5x50



**D3750T18S**

14.20€

Juego de 8 destornilladores de precisión

Composición:

Ref.	Medida (mm)	Ref.	Medida (mm)
D3750P00	P00x50	D3750T7	T7x50
D3750T4	T4x50	D3750A1	horquilla 50
D3750T5	T5x50	D3750A2	inclinación 50
D3750T6	T6x50	D3750A3	aguja 50



**DR0253S**

46.00€

Juego de puntas y porta puntas flexible

Composición/ medidas (mm):

Porta puntas flexible  
Puntas phillips: #1; #2 y #3  
Puntas plano: 3; 4; 5,5; y 7  
Puntas pozi: #0; #1; #2; y #3  
Puntas hexagonal: 2; 2,5; 3; 4; 5 y 6  
Puntas torx tamperproof: T8; T10; T15; T20; T25; T27; T20 y T40  
Puntas torx: T6; T8; T9; T10; T15; T20; T25; T27; T30 y T40  
Adaptador 1/4" hexagonal  
Adaptador magnético



**DR0107S**

12.00€

Juego de puntas largas y porta puntas

Composición/ medidas (mm):

Porta puntas  
Puntas dobles 65mm  
Pozi 1/ plano 5mm  
Pozi 2/ plano 6mm  
Pozi 3/ plano 7mm  
Hexagonal 3mm/ 4mm  
Hexagonal 5mm/ 6mm  
Phillips/ plano 6mm



**DBT31B**
**14.50€**
**Juego de punta de puño**

Composición/ medidas (mm):

- Porta puntas de puño
- Puntas phillips
- Puntas planas
- Puntas pozi
- Puntas hexagonais
- Puntas torx

**RD01032S**
**31.30€**
**Juego trinquete con puntas 1/4" con 32 piezas**

Composición:

- Trinquete 1/4" de 60 dientes
- Porta puntas magnético
- Puntas phillips
- Puntas allen
- Puntas cuadrados
- Puntas pozi
- Puntas torx
- Puntas planas
- Puntas torx tamperproof

**S08H208S**
**6.30€**
**Juego de porta puntas angular (90°)**

Composición:

- 7 Puntas 1/4"

**S14A4**
**Llave para retirar hembras dañadas 1/2"**

Ref.	Medida (mm)	Precio
S14A4117	17	9.90€
S14A4118	18	10.00€
S14A4121	21	10.40€

**S14A4108S**
**82.50€**
**Juego de 8 llaves para retirar hembras dañadas 1/2"**

Composición/ medidas (mm):

Llaves: 17; 18,5; 20; 21,5; 23; 24,5; 26 y 27,5

**S29H2133S**
**11.50€**
**Juego de porta puntas 1/4" con 33 piezas**

Composición:

- Porta puntas magnético
- Puntas torx
- Puntas torx tamperproof
- Puntas perfil "Tri Wing"
- Puntas perfil "Spanner"
- Puntas hexagonales



## Destornilladores

las puntas se venden en paquetes de 10 unidades  
los precios son por unidad

### D125P



Puntas/ bits de 1/4" phillips

Ref.	Medida (mm)	Longitud (mm)	Precio
D125P1F	PH1	25	0.30€
D125P2F	PH2	25	0.30€

### D150P

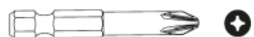

Puntas/ bits de 1/4" phillips

Ref.	Medida (mm)	Longitud (mm)	Precio
D150P1A	PH1	50	0.50€
D150P2A	PH2	50	0.50€
D150P3A	PH3	50	0.50€

### D125Z



Puntas/ bits de 1/4" pozi

Ref.	Medida (mm)	Longitud (mm)	Precio
D125Z1A	PZ1	25	0.30€
D125Z2A	PZ2	25	0.30€
D125Z3A	PZ3	25	0.30€

### D150Z

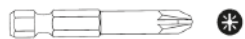

Puntas/ bits de 1/4" pozi

Ref.	Medida (mm)	Longitud (mm)	Precio
D150Z1A	PZ1	50	0.50€
D150Z2A	PZ2	50	0.50€
D150Z3A	PZ3	50	0.50€

### D150F

Puntas/ bits de 1/4" plano

Ref.	Medida (mm)	Longitud (mm)	Precio
D150F5510A	1x5,5	50	0.50€
D150F6512A	1,2x6,5	50	0.50€
D150F8012A	1,2x8	50	0.50€

### D125H

Puntas/ bits de 1/4" allen

Ref.	Medida (mm)	Longitud (mm)	Precio
D125H015A	1,5	25	0.30€
D125H020A	2	25	0.30€
D125H025A	2,5	25	0.30€
D125H030A	3	25	0.30€
D125H040A	4	25	0.30€
D125H050A	5	25	0.30€
D125H060A	6	25	0.30€

### D130H

Puntas/ bits de 1/4" allen

Ref.	Medida (mm)	Longitud (mm)	Precio
D130H40	4	30	0.80€
D130H50	5	30	0.80€
D130H60	6	30	0.80€
D130H70	7	30	0.80€
D130H80	8	30	0.80€
D130H100	10	30	0.90€
D130H120	12	30	1.00€

### D150H

Puntas/ bits de 1/4" allen

Ref.	Medida (mm)	Longitud (mm)	Precio
D150H050A	5	50	0.50€
D150H060B	6	50	0.50€
D150H070B	7	50	0.60€
D150H080B	8	50	0.60€

### D175H

Puntas/ bits de 1/4" allen

Ref.	Medida (mm)	Longitud (mm)	Precio
D175H40	4	75	1.20€
D175H50	5	75	1.20€
D175H60	6	75	1.20€
D175H70	7	75	1.25€
D175H80	8	75	1.30€
D175H100	10	75	1.35€
D175H120	12	75	1.65€

### D10M

Puntas/ bits estriadas 10mm XZN

Ref.	Medida (mm)	Longitud (mm)	Precio
D10M30M05A	M5	30	0.80€
D10M30M06A	M6	30	0.80€
D10M30M08A	M8	30	0.80€
D10M30M10A	M10	30	0.80€
D10M30M12A	M12	30	1.00€
D10M30M14A	M14	30	1.10€
D10M75M05A	M5	75	1.30€
D10M75M06A	M6	75	1.30€
D10M75M08A	M8	75	1.30€
D10M75M10A	M10	75	1.30€
D10M75M12A	M12	75	1.70€
D10M75M14A	M14	75	1.85€



### D125T

Puntas/ bits de 1/4" torx

Ref.	Medida (mm)	Longitud (mm)	Precio
D125T10A	T10	25	0.30€
D125T15A	T15	25	0.30€
D125T20A	T20	25	0.30€
D125T25A	T25	25	0.30€
D125T27A	T27	25	0.30€
D125T30A	T30	25	0.30€
D125T40A	T40	25	0.30€



### D130T

Puntas/ bits de 3/8" torx

Ref.	Medida (mm)	Longitud (mm)	Precio
D130T20	T20	30	0.80€
D130T25	T25	30	0.80€
D130T30	T30	30	0.80€
D130T40	T40	30	0.80€
D130T45	T45	30	0.80€
D130T50	T50	30	0.90€
D130T55	T55	30	1.20€



### D150T

Puntas/ bits de 1/4" torx

Ref.	Medida (mm)	Longitud (mm)	Precio
D150T20A	T20	50	0.50€
D150T25A	T25	50	0.50€
D150T27A	T27	50	0.50€
D150T30A	T30	50	0.50€
D150T40A	T40	50	0.50€



### D175T

Puntas/ bits de 3/8" torx

Ref.	Medida (mm)	Longitud (mm)	Precio
D175T20	T20	75	1.20€
D175T25	T25	75	1.20€
D175T30	T30	75	1.20€
D175T40	T40	75	1.20€
D175T45	T45	75	1.20€
D175T50	T50	75	1.20€
D175T55	T55	75	1.25€



## Destornilladores

### S29H2180S

31.00€

Conjunto de 180 puntas

Composición:

Phillips  
Pozi  
Allen  
Torx



### H01B



Llave allen corta

Ref.	Medida (mm)	Precio
H01B1030	3	0.20€
H01B1040	4	0.40€
H01B1050	5	0.60€
H01B1060	6	0.70€
H01B1070	7	0.90€
H01B1080	8	1.10€
H01B1090	9	1.40€
H01B1140	14	4.00€
H01B1170	17	6.00€
H01B1190	19	8.10€
H01B1220	22	13.20€



### H01MH118S



33.00€

Juego de 18 llaves allen cortas

Composición/ medidas (mm):

Llaves: 1,5; 2; 2,5; 3; 3,5;  
4; 4,5; 5; 5,5; 6; 7; 8; 9; 10;  
12; 14; 17 y 19



**H01SA**



Llaves allen cortas antideslizantes

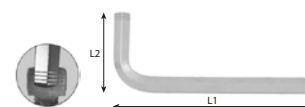

Ref.	Medida (mm)	L1 (mm)	L2 (mm)	Precio
H01SA115	1,5	46,5	15,5	0.50€
H01SA120	2	52	18	0.50€
H01SA125	2,5	58,5	20,5	0.50€
H01SA130	3	66	23	0.70€
H01SA140	4	74	29	1.00€
H01SA150	5	85	33	1.10€
H01SA160	6	96	38	1.60€
H01SA180	8	108	44	1.80€
H01SA1100	10	122	50	2.80€

**H01SA109S**



9.50€

Juego de 9 llaves allen cortas  
Sistema especial antideslizante

Composición/ medidas (mm):  
Llaves: 1,5; 2; 2,5; 3;  
4; 5; 6; 8 y 10



**H03MH118S**



60.50€

Juego de 18 llaves allen extra largas

Composición/ medidas (mm):  
Llaves: 1,5; 2; 2,5; 3; 3,5; 4;  
4,5; 5; 5,5; 6; 7; 8; 9;  
10; 12; 14; 17 y 19



**H01SM109S**



9.00€

Juego de 9 llaves allen cortas

Composición/ medidas (mm):  
Llaves: 1,5; 2; 2,5; 3;  
4; 5; 6; 8 y 10



**H03SM109S**



12.80€

Juego de 9 llaves allen extra largas

Composición/ medidas (mm):  
Llaves: 1,5; 2; 2,5;  
3; 4; 5; 6; 8 y 10



**H02MH217S**



50.00€

Juego de 17 llaves allen largas SAE

Composición/ medidas:  
Llaves: 1/16"; 5/64"; 3/32";  
7/64"; 1/8"; 9/64"; 5/32"; 3/16";  
1/4"; 5/16"; 3/8"; 7/16";  
1/2"; 9/16"; 5/8" y 3/4"



**H05SA109S**



12.60€

Juego de 9 llaves allen largas con punta esférica antideslizante

Composición/ medidas (mm):  
Llaves: 1,5; 2; 2,5; 3;  
4; 5; 6; 8 y 10

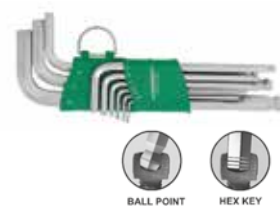

**H02SM109S**



11.50€

Juego de 9 llaves allen largas

Composición/ medidas (mm):  
Llaves: 1,5; 2; 2,5; 3; 4;  
5; 6; 8 y 10



**H06MT109S**



16.50€

Conjunto de 9 llaves allen largas con punta esférica

Composición/ medidas (mm):  
Llaves: 1,5; 2; 2,5; 3;  
4; 5; 6; 8 y 10 mm



**H02SM209S**



11.50€

Juego de 9 llaves allen largas SAE

Composición/ medidas:  
Llaves: 1/16"; 5/64";  
3/32"; 1/8"; 5/32";  
3/16"; 1/4"; 5/16" y 3/8"



**H06SA**

**Llaves allen extra largas con punta esférica antideslizante**

Ref.	Medida	L1 (mm)	L2 (mm)	Precio
H06SA115	1,5	91,5	15,5	0.60€
H06SA120	2	102	18	0.60€
H06SA125	2,5	114,5	20,5	0.60€
H06SA130	3	129	23	0.80€
H06SA140	4	144	29	1.10€
H06SA150	5	165	33	1.20€
H06SA160	6	186	38	1.80€
H06SA180	8	208	44	2.30€
H06SA1100	10	234	50	3.40€

**H06SA109S**

**13.50€**
**Juego de 9 llaves allen macho extra largas con punta esférica antideslizante**

**H06SM209S**

**13.70€**
**Juego de 9 llaves allen con punta esférica SAE**

Composición/ medidas (mm):

 Llaves: 1/16"; 5/64";  
 3/32"; 1/8"; 5/32"; 3/16";  
 1/4"; 5/16" y 3/8"

**H07M09S**

**10.40€**
**Juego de 9 llaves torx**

Composición/ medidas (mm):

 Llaves: T10; T15; T20; T25;  
 T27; T30; T40; T45 y T50

**H08MTP09S**

**12.20€**
**Juego de 9 llaves torx tamperproof**

Composición/ medidas (mm):

 Llaves: T10; T15; T20; T25;  
 T27; T30; T40; T45 y T50

**H08S110S**

**18.50€**
**Juego de 10 llaves torx largas tamperproof**

Composición/ medidas (mm):

 Llaves: T9; T10; T15; T20;  
 T25; T27; T30; T40; T45 y T50

**H08ST**

**Llave torx larga tamperproof**

Ref.	Medida	Longitud (mm)	Precio
H08ST09085	T9	80	1.20€
H08ST10090	T10	90	1.20€
H08ST15100	T15	100	1.30€
H08ST20115	T20	112	1.40€
H08ST25130	T25	126	1.50€
H08ST27145	T27	142	1.60€
H08ST30165	T30	160	1.80€
H08ST40185	T40	180	2.20€
H08ST45205	T45	200	2.50€
H08ST50230	T50	224	3.30€

**H10MB**

**Llave allen doble con mango y punta esférica**

Ref.	Medida	Precio
H10MB2100	2x100	2.20€
H10MB25100	2,5x100	2.30€
H10MB3100	3x100	2.30€
H10MB4100	4x100	2.40€
H10MB5150	5x150	2.80€
H10MB6150	6x150	3.10€
H10MB8200	8x200	3.90€
H10MB10200	10x200	5.30€

**H10MB08S**

**29.00€**
**Juego de 8 llaves allen dobles con mango**

Composición/ medidas (mm):

 Llaves: 2x100; 2,5x100;  
 3x100; 4x100; 5x150; 6x150;  
 8x200 y 10x200

## Destornilladores

### H10MT



Llave doble con mango torx tamperproof

Ref.	Medida	Precio
H10MT10100	T10x100	2.30€
H10MT15100	T15x100	2.30€
H10MT20100	T20x100	2.50€
H10MT25100	T25x100	2.60€
H10MT27150	T27x150	2.70€
H10MT30150	T30x150	3.00€
H10MT40150	T40x150	3.40€
H10MT45200	T45x200	4.20€
H10MT50200	T50x200	4.70€

### H10MT09S

32.50€

Juego de 9 llaves doble torx tamperproof con mango

Composición/ medidas (mm):

Llaves: T10x100; T15x100;  
T20x100; T25x100; T27x150;  
T30x150; T40x150; T45x200  
y T50x200



### H12S



Llaves torx extra largas

Ref.	Medida	L1 (mm)	L2 (mm)	Precio
H12S09085	T9	85	5	1.20€
H12S10090	T10	90	5,5	1.20€
H12S15100	T15	100	8	1.30€
H12S20115	T20	115	12,5	1.40€
H12S25130	T25	130	18	1.50€
H12S27145	T27	145	24,5	1.70€
H12S30165	T30	165	40	2.00€
H12S40185	T40	185	62	2.40€
H12S45205	T45	205	98	2.70€
H12S50230	T50	230	128	3.60€



### H12S110S



18.40€

Juego de 10 llaves torx largas

Composición/ medidas (mm):

Llaves: T9; T10;  
T15; T20; T25; T27;  
T30; T40; T45 y T50



### H15M105S

13.50€

Juego de 5 llaves XZN en "L"

Composición/ medidas (mm):

Llaves: M5; M6; M8; M10 y M12



### H20MB1037S



52.00€

Juego de 9 llaves allen de punta esférica con mango y 28 puntas

Composición/ medidas (mm):

**H20MB** Llaves: H1,5X100; H2X100; H2,5X110; H3X120;  
H4X125; H5X155; H6X165; H8X185 y H10X210  
Puntas phillips: PH1; PH2 y PH3  
Puntas pozi: PZ1; PZ2 y PZ3  
Puntas torx: T10; T15; T20; T25; T27; T30; T35 y T40  
Puntas planas: 3; 4; 5; 6 y 7  
Puntas XZN: M4; M5 y M6  
Puntas cuadradas: 1; 2 y 3  
Puntas spanner: 4 y 6



**H20MT**

Llaves torx dobles con mango



Ref.	Medida	L1 (mm)	L2 (mm)	Precio
H20MT10	T10	110	15	2.80€
H20MT15	T15	120	15	2.90€
H20MT20	T20	125	16	3.30€
H20MT25	T25	135	16	3.50€
H20MT27	T27	145	16	3.70€
H20MT30	T30	155	16	4.10€
H20MT40	T40	165	16	4.60€
H20MT45	T45	185	16	5.40€
H20MT50	T50	205	20	6.40€

**H20MT09S**

48.00€

Juego de 9 llaves torx dobles con mango

Composición/ medidas (mm):

Llaves: T10x110; T15x120; T20x125; T25x135; T27x145; T30x155; T40x165; T45x185 y T50x205

**H22S109S**



16.50€

Juego de 9 llaves allen extra largas XZN

Especial para quitar los tornillos dañados

Composición/ medidas (mm):

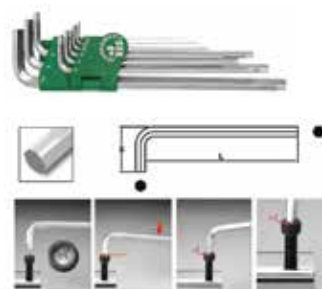
Llaves: 1,5; 2; 2,5; 3; 4; 5; 6; 8 y 10



## Martillos

**M03025**

24.20€

Maza de metal

Peso: 1 330g



**M040**

Martillo con cabeza redonda y punta esférica

Ref.	Peso (g)	Longitud (mm)	Precio
M04008	395	278	11.00€
M04012	527	283	11.70€
M04016	780	327	13.20€
M04024	1 063	383	18.00€
M04032	1 208	385	18.50€



**M05020**

16.00€

Martillo de carpintero

Peso: 830g

Longitud: 330mm



**M060**

Maza

Ref.	Peso (g)	Longitud (mm)	Precio
M06030	1 550	263	17.50€
M06040	2 250	276	21.00€



**M07016**

16.00€

Martillo plástico y goma

Peso: 840g

Longitud: 314mm



**M07016-ACE**

2.80€

Tapa amarilla para recambio M07016



**M07016-TPR**

1.40€

Tapa negra para recambio M07016



**JONNESWAY**

**M29**

Martillo plástico y goma intercambiables

Ref.	Diámetro (mm)	Longitud (mm)	Precio
M2927	27	270	18.80€
M2940	40	330	31.50€



**M2927**

Tapa para martillo M2927

Ref.	Color	Precio
M2927-T1	blanca	2.30€
M2927-T2	amarilla	3.50€



**M2940**

Tapa para martillo M2940

Ref.	Color	Precio
M2940-T1	blanca	3.60€
M2940-T2	amarilla	5.40€



**M09**

Martillo de mecánico

Ref.	Peso (g)	Longitud (mm)	Precio
M09100	100	260	7.10€
M09200	200	280	8.20€
M09300	300	300	9.30€
M09500	500	320	11.20€
M09800	800	350	16.00€
M091000	1 000	360	19.00€



**M110**

Martillo antirrebote de goma

Ref.	Peso (g)	Longitud (mm)	Precio
M11035	400	260	13.50€
M11045	520	286	16.50€
M11065	1500	370	28.00€



**M601**
**Punzón de pico**

Ref.	D (mm)	D1 (mm)	L (mm)	Precio
M60102	2	9,5	120	1.90€
M60104	4	9,5	120	2.10€
M60105	5	12	120	2.40€

**M611**
**Cinzel**



Ref.	D (mm)	D1 (mm)	L (mm)	Precio
M61110	10	9,5	150	1.90€
M61112	12	9,5	130	2.20€
M61113	13	9,5	150	2.30€
M61116	16	12,7	180	3.50€
M61119	19	15,8	180	4.40€
M61122	22	15,8	200	4.70€
M61125	25	19	200	6.60€

**M621**
**Punzón**

Ref.	D (mm)	D1 (mm)	L (mm)	Precio
M62102	2	9,5	120	1.60€
M62103	3	9,5	120	1.60€
M62104	4	9,5	120	1.60€
M62105	5	9,5	120	1.60€
M62106	6	9,5	120	1.60€
M62108	8	9,5	120	1.90€

**M631**
**Punzones**

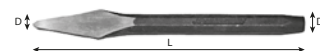
Ref.	D (mm)	D1 (mm)	L (mm)	Precio
M63102	2	8	115	1.90€
M63103	3	8	125	1.90€
M63104	4	9,5	150	2.20€
M63105	5	9,5	165	2.40€
M63106	6	12,7	180	3.00€
M63108	8	12,7	180	3.10€

**M641**
**Buril**

Ref.	D (mm)	D1 (mm)	L (mm)	Precio
M64105	5	9,5	130	2.80€

## Varios

### M61H1

Cortafrios con mango de protección

Ref.	Tipo	Medida (mm)	Precio
M61H116	16	170	5.50€
M61H119	19	190	7.00€
M61H124	24	220	10.70€



### M62H1

Punzón con mango de protección

Ref.	Tipo	Medida (mm)	Precio
M62H102	2	185	5.00€
M62H103	3	185	5.10€
M62H104	4	185	5.20€
M62H106	6	185	5.30€



### M63106S

14.50€

Juego de 6 punzones

Composición/ medidas (mm):

2x8x115; 3x8x125;  
4x9,5x150; 5x9,5x165;  
6x12,7x180 y 8x12,7x180



### M63H1

Punzones con mango de protección

Ref.	Tipo	Medida (mm)	Precio
M63H103	3	150	4.00€
M63H105	5	200	5.30€
M63H106	6	210	6.50€
M63H108	8	220	7.50€



### M63M106S

16.00€

Juego de 6 punzones cromo

Composición/ medidas (mm):

2x8x115; 3x8x125; 4x9,5x150;  
5x9,5x165; 6x12,7x180 y 8x12,7x180

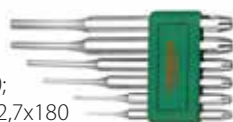

### M64105S

10.70€

Juego de 5 punzones y cortafrios

Composición/ medidas (mm):

Punzón: 2x8x115; 3x8x125;  
4x9,5x150; 5x9,5x165; 6x12,7x180  
Cortafrio: 8x12,7x180



### M64M105S

10.50€

Juego de 5 punzones y cortafrios cromo

Composición/ medidas (mm):

Punzón: 3x 9,5x120  
Punzón pico: 2x9,5x120  
Cíncel: 12x9,5x130  
Botadores: 4x9,5x150  
Cortafrio: 5x9,5x130



### MF05

Limas

Ref.	Tipo	Medida (mm)	Precio
MF05A	chata	200	7.50€
MF05B	redonda	200	6.50€
MF05C	media caña	200	8.00€
MF05D	plaza	200	7.50€
MF05E	triangular	200	7.50€

### MF05S

43.00€

Juego de 5 limas de 200mm

Composición:

MF05A Lima chata  
MF05B Lima redonda  
MF05C Lima media caña  
MF05D Lima plaza  
MF05E Lima triangular



### MFM06S

22.00€

Juego de 6 mini limas de 100mm

Composición:

Mini lima redonda  
Mini lima triangular  
Mini lima plaza  
Mini lima media caña  
Mini lima plana  
Mini lima plana en pico



### MHS100AG

16.50€

Sierra



### P9601

10.70€

Navaja pela cables





**MK2040** 8.70€

Cuter de cuchilla retráctil  
Con 2 cuchillas de reemplazo



**MK2040-B** 1.40€

Cuchilla de cutter MK2040 - 5 unidades

**MK2080** 9.80€

Cuter de cuchilla retráctil  
Con 2 cuchillas de reemplazo



**MKS27** 19.20€

Juego de cutter

Composición:

Cuter  
Raspador  
Accesorios



**MKS27**

Cuchilla raspadora - 100 unidades

Ref.	Tipo	Medida (mm)	Precio
MKS27-12	A	12	18.00€
MKS27-16	B	16	18.00€
MKS27-16A	C	(53°) 16	21.50€
MKS27-20	D	20	18.00€

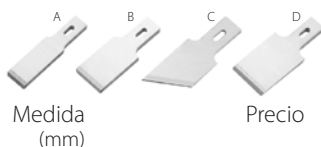

**MT0204** 8.00€

Flexómetro

Corpo en plástico ABS

Longitud: 8m



**MT0701** 3.70€

Flexómetro de alta resistencia

Longitud: 3m



**MT0702** 4.50€

Flexómetro

Cuerpo en plástico ABS resistente al choque

Longitud: 5m



## Varios

**MTC1**

Calibre lectura vigesimal

Ref.	Longitud (mm)	Precio
MTC1150	150	36.00€
MTC1200	200	54.00€
MTC1300	300	98.00€



**MTC153**

Escuadra en metal

Dimensiones: 300x40x1 mm



**MTC156**

Regla en metal

Dimensiones: 334x23,7x1 mm



**MTC200**

Calibre digital

Longitud: 200mm

95.00€



**MTC3**

Compás de precisión puntas rectas

Ref.	Longitud (mm)	Precio
MTC306	150	15.50€
MTC308	200	17.50€

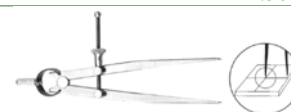

**MTC408**

Compás de precisión puntas curvadas para exteriores

Longitud: 200mm

17.20€

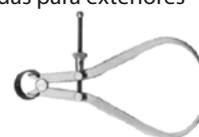

**MTC508**

Compás de precisión puntas curvadas para interiores

Longitud: 200mm

16.30€



**MTM1**

Micrómetro exteriores

Ref.	Medida (mm)	Precio
MTM1025	0-25	29.90€
MTM1050	25-50	35.50€
MTM1075	50-75	40.10€
MTM1100	75-100	47.00€



**AG010207**

75.00€

Gambiarras de Leds

Incluye: Cargador 220v AC/ 5v DC y cable USB

Dimensiones: 375x30x30mm      Potencia: 15W  
 Cargador: 220v/ 50Hz      Capacidad da batería: 2,5 a 10h  
 Flujo luminoso: 410 lumen      Tiempo de carga: 3,5 a 4h  
 Iluminancia máxima: 935 luz proyectada a 50cm  
 Batería recargable : Li-ion 3,7v 2 200mAh



**C-DM1**

22.00€

Barra magnética

Dimensiones: 475x52x17mm



**DV13P**
**Destornillador plano aislado (1000 Volts)**

Ref.	Medida	L1 (mm)	L2 (mm)	L (mm)	Precio
DV13P060	PH0	60	98	158	3.10€
DV13P180	PH1	80	104	184	4.00€
DV13P2100	PH2	100	110	210	4.40€
DV13P3150	PH3	150	120	270	5.40€

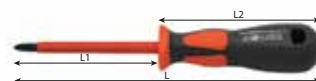
**DV13S**
**Destornillador plano aislado (1000 Volts)**

Ref.	Medida (mm)	L1 (mm)	L2 (mm)	L (mm)	Precio
DV13S275	2,5	75	98	173	3.20€
DV13S4100	4	100	98	198	3.60€
DV13S5125	5,5	125	104	229	4.20€
DV13S6150	6,5	150	110	260	4.90€

**DV13PP07S**
**30.50€**
**Juego de destornilladores aislados plano/ phillips (1000 Volts)**

Composición/ medidas (mm):

 Destornilladores plano: 4x100; 5,5x125 y 6,5x150  
 Destornilladores phillips: PH0x60; PH1x80 y PH2x100  
 Busca-polos

**DV41M**
**Vasos destornilladores aislados con mango (1000 Volts)**

Ref.	Medida	Longitud (mm)	Precio
DV41M5	M5	125	6.00€
DV41M6	M6	125	6.20€
DV41M7	M7	125	6.20€
DV41M8	M8	125	6.30€
DV41M10	M10	125	6.40€
DV41M13	M13	125	6.70€

**DV41M06S**
**38.50€**
**Juego de 6 vasos destornilladores aislados con mango (1000 Volts)**

Composición/ medidas:

Vasos destornilladores: M5; M6; M7; M8; M10 y M13

**MKV7**
**10.00€**
**Cuter aislado 1000V**

 Longitud: 180mm  
 Hoja: 50mm

**MKV7-K**
**14.00€**
**Cuchilla para cutter aislado 1000 volts - 4 unidades**

**MKV8**
**16.00€**
**Navaja aislada 1000V**

 Longitud: 180 mm  
 Cuchilla: 50mm

**PV018** 26.00€

**Alicate universal**  
Cumple la norma IEC 60900  
Longitud: 215mm



**PV0518** 23.00€

**Alicate corta cables (trabajo intensivo)**  
Cumple la norma IEC 60900  
Longitud: 200mm  
Capacidad de corte: Ø13/60mm



**PV068** 20.20€

**Alicate de puntas curvas**  
Cumple la norma IEC 60900  
Longitud: 200mm



**PV0918** 22.00€

**Alicate de corte**  
Cumple la norma IEC 60900  
Longitud: 200mm



**PV1118** 15.70€

**Alicate de puntas**  
Cumple la norma IEC 60900  
Longitud: 200mm



**PV1416** 15.50€

**Alicate de puntas chatas**  
Cumple la norma IEC 60900  
Longitud: 160mm



**PV1516** 15.70€

**Alicate de descarnar fios (trabajo intensivo)**  
Cumple la norma IEC 60900  
Longitud: 160mm



**PV28110** 24.00€

**Alicate ajustable**  
Cumple la norma IEC 60900  
Longitud: 275mm



**PV4006** 19.40€

**Alicate de puntas redondas**  
Cumple la norma IEC 60900  
Longitud: 200mm



**PSV108SP** 86.00€

**Juego de 3 alicates y 5 destornilladores aislados 1 000V**

Composición/ medidas en mm:  
PV087 Alicate universal  
PV1108 Alicate universal de puntas  
PV106 Alicate de corte 5,5x125  
DV1SPP-TP Buscapolos 220-250v  
DV13S5125 Destornillador 5,5x125  
DV13S6150 Destornillador 6,5x150  
DV13P180 Llave phillips P1x80  
DV13P2100 Llave phillips P2x100

**B**



**PSV110SC** 145.00€

**Juego de 10 herramientas aisladas 1 000V**

Composición:  
4 Alicates  
4 Destornilladores/ phillips  
1 Navaja  
1 Buscapolos

**C**



**S03V21**

**Llaves de vaso 1/4" aisladas a 1 000V**

Ref.	Medida (mm)	Longitud (mm)	Precio
S03V2106	6	41	4.50€
S03V2108	8	41	5.00€
S03V2110	10	41	5.50€
S03V2114	14	41	6.00€



**S03V31**

**Llaves de vaso 3/8" aisladas a 1 000V**

Ref.	Medida (mm)	Longitud (mm)	Precio
S03V3108	8	44,5	7.00€
S03V3110	10	44,5	7.20€
S03V3112	12	44,5	7.50€
S03V3113	13	44,5	7.70€
S03V3114	14	44,5	8.00€
S03V3117	17	44,5	8.20€
S03V3119	19	46	8.80€
S03V3122	22	46	9.50€



**S03V41**

Llaves de vaso 1/2" aisladas a 1 000V



Ref.	Medida (mm)	Longitud (mm)	Precio
S03V4110	10	55	8.50€
S03V4111	11	55	8.80€
S03V4112	12	55	9.00€
S03V4113	13	55	9.50€
S03V4114	14	55	10.00€
S03V4117	17	55	10.50€
S03V4119	19	57	10.80€
S03V4122	22	57	11.50€
S03V4124	24	57	12.00€
S03V4127	27	59	13.50€
S03V4132	32	59	16.00€

**S03V3116SC**

235.00€

Juego de 16 piezas 3/8" con trinquete aislado a 1 000V

Composición/ medidas en mm:

- RV033 Trinquete aislado 200
- S43V38 Mango corredizo en T 200
- S25V36 Extensión 150
- S25V310 Extensión 250
- S03V3 Llaves de vaso: 8; 10; 12; 13; 14; 17; 19 y 22
- S09V3 Puntas: 4; 5; 6 y 8

**B**

**S03V4120SC**

330.00€

Juego de 20 piezas 1/2" con trinquete aislado a 1 000V

Composición/ medidas en mm:

- RV034 Trinquete aislado 250
- S43V48 Mango corredizo en T 200
- S25V45 Extensión 125
- S25V410 Extensión 250
- S03V4 Llaves de vaso: 10; 11; 12; 13; 14; 17; 19; 22; 24; 27 y 32
- S09V4 Puntas: 4; 5; 6; 8 y 10

**C**

**S43V**

Cable en T aislado a 1 000V

Ref.	Boquilla	Longitud (mm)	Peso (g)	Precio
S43V38	3/8"	200	240	36.00€
S43V48	1/2"	250	330	39.00€

**S09V3H**

Llaves de vaso hexagonal 3/8" aisladas a 1 000V



Ref.	Medida (mm)	Longitud (mm)	Precio
S09V3H4	4	60	7.00€
S09V3H5	5	60	7.20€
S09V3H6	6	60	7.70€
S09V3H8	8	60	8.00€

**S09V41H**

Llaves de vaso 3/8" aisladas a 1 000V



Ref.	Medida (mm)	Longitud (mm)	Precio
S09V41H4	4	120	9.50€
S09V41H5	5	120	9.70€
S09V41H6	6	120	10.00€
S09V41H8	8	120	10.50€
S09V41H10	10	120	11.00€

**S25V3**

Extensor 3/8" aislado a 1 000V



Ref.	Longitud (mm)	Peso (g)	Precio
S25V36	150	150	26.00€
S25V310	250	250	29.00€

**S25V4**

Extensor 1/2" aislado a 1 000V



Ref.	Longitud (mm)	Peso (g)	Precio
S25V45	150	210	30.00€
S25V410	250	410	32.00€

**RV03**

Trinquete aislado a 1 000V



Ref.	Boquilla	Longitud (mm)	Peso (g)	Precio
RV032	1/4"	150	140	39.00€
RV033	3/8"	200	300	49.00€
RV034	1/2"	250	570	57.00€

**W23V1**

Llaves estrella aisladas a 1 000V

Ref.	Medida (mm)	Longitud (mm)	Precio
W23V108	8	164	16.00€
W23V110	10	174	17.00€
W23V111	11	184	18.00€
W23V112	12	184	18.50€
W23V113	13	205	19.50€
W23V114	14	205	20.00€



**W25V1**

Llaves de vaso 3/8" aisladas a 1 000V

Ref.	Medida (mm)	Longitud (mm)	Precio
W25V108	8	104	12.00€
W25V109	9	104	12.50€
W25V110	10	114	13.00€
W25V113	13	154	14.00€
W25V114	14	154	14.50€



**WV27AS10**

45.50€

Llave ajustable aislada 1000V

Apertura: 33mm  
Longitud: 200mm





**JONNESWAY**®

**Especial Mecánica**



**Mecánica**



**Pesados**



**Motocicletas**



**Accesorios**



**Chapista**

**Herramienta específica - ramo automovil**
**AB030056** 34.50€
**Inflador de aire para apertura de puerta**

Longitud: 230mm

**AB030061** 20.70€
**Herramienta para retirar el brazo limpia parabrisas**

**AE040020** 57.00€
**Cilindro hidráulico**

 Longitud: 140mm cerrado | 215mm extendido  
 Capacidad: 2t

**AE150005** 96.00€
**Dos caballetes de 3t con apoyo de goma**

 Altura máxima: 440mm  
 Altura mínima: 290mm

**AE300064** 202.00€
**Kit prueba de presión para radiadores con 17 piezas**

Composición:

- AE30064-02 Audi A4, A5, A6
- AE30064-03 Opel, Ford, VW
- AE30064-04 BMW
- AE30064-05 BMW
- AE30064-06 Volvo, Citroën, Renault, Fiat, Peugeot
- AE30064-07 Audi, VW
- AE30064-08 Sede ajustable
- AE30064-09 Pino união 50mm
- AE30064-10 Pino unión 35mm
- AE30064-11 Pino unión 27mm
- AE30064-12 Adaptador para 8; 9 y 11
- AE30064-13 Adaptador
- AE30064-14 Fijador
- AE30064-15 Honda, Toyota
- AE30064-16 Mitsubishi, Honda, Ford, Nissan, Mazda

**AE3000**
**Tapones para prueba del radiadores**

Ref.	Precio
AE300064-02	18.00€
AE300064-03	18.00€
AE300064-04	18.00€
AE300064-05	18.00€
AE300064-06	14.50€
AE300064-07	14.50€
AE300064-15	22.00€
AE300064-16	22.00€

**AE300100-040** 20.50€
**Tapones para kit de presión de radiadores - Ford**

Aplicable en el kit AE300064

**AE300100-042** 20.50€
**Tapones para kit de presión de radiadores - Ford**

Aplicable en el kit AE300064

**AE300100-060** 21.50€
**Tapones para kit de presión de radiadores - Mercedes**

Aplicable en el kit AE300064

**AE300103** 15.50€
**Bandeja de recoger aceite y anticongelante**

 Dimensiones: 600x450x180mm  
 Capacidad: 16l

**AE300152** 170.00€
**Kit prueba de presión de radiador con 5 piezas**



**AE300173**
**17.50€**

Sangrador de líquido de embrague y frenos  
Fácil, rápido y eficiente utilizando el aire de los neumáticos

**AE300176-A**
**48.00€**

3 Adaptadores especiales para VW/ Audi/ Mercedes

**AE300212**
**118.00€**

Distribuidor de aceite de transmisiones

Dimensiones: 240x200x440mm

Capacidad: 4l

Peso: 1 600g

Bomba de mano y 4 adaptadores

**AE310002**
**230.00€**

Conjunto extractor hidráulico con accesorios

Capacidad: 90-145mm

**AE310006**
**85.00€**

Conjunto de 2 extractores guillotina

Capacidad: 30-75mm

**AE310008**
**140.00€**

Extractor interior y exterior

Capacidad: 15-30 y 30-80mm interna  
15-80mm externa

**AE310010A**
**102.00€**

Juego de extractor semieje

**AE310013**
**80.00€**

Extractor universal de buje de la rueda

Capacidad: 90-140 y 130-180mm

**AE310014**
**154.50€**

Extractor de buje de la rueda y semieje

Capacidad: 90-140 y 130-180mm

**AE310016**
**45.00€**

Extractor semieje

**AE310023**
**40.50€**

Extractor de rotulas

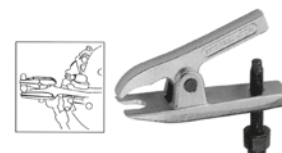

**AE3100****Extractor de 3 brazos**

Ref.	Tamaño	Apertura (mm)	Capacidad (t)	Precio
AE310034	3"	40-76	2	17.50€
AE310035	4"	50-102	5	25.00€
AE310037	8"	80-203	12	95.00€
AE310038	12"	120-305	18	212.00€

**AE310063**

62.00€

**Extractor para rodamientos pequeños**

Especialmente adecuado para la eliminación de pequeños cojinetes en el automóvil, reparación de instalaciones industriales y domésticas.

Capacidad: 1t

Apertura: 19 a 45mm

Rango de profundidad: 73mm

**AE310087**

71.00€

**Extractor universal de rótulas**

Especialmente diseñado para su uso en situaciones de espacio reducido

Aplicable: Audi, VW, BMW, Ford, Mercedes (W170, W202, W210, W220), Opel, Mitsubishi ...

**AE310066**

23.00€

**Extractor para volantes de dirección**

Aplicable: Opel, Ford entre otros

**AE310099**

103.50€

**Extractor de 2 y 3 brazos para interiores y exteriores**

Capacidad: 20t

Apertura: 76-178mm



Alterável para:

**AE310077**

31.20€

**Extractor de rótulas**

Apertura: 20mm

**AE310122**

82.00€

**Extractor de rótulas****AE3101****Extractor de 3 brazos**

Ref.	Ø (mm)	Ancho (mm)	Altura (mm)	Precio
AE310109	18	40	35	29.50€
AE310110	23	50	45	37.00€
AE310112	40	80	80	78.00€

**AE3101****Extractor de 2 brazos**

Ref.	Ajuste Int. (mm)	Ajuste Ext. (mm)	Altura (mm)	Precio
AE310146B	25-80	70-130	100	45.00€
AE310146D	50-160	105-220	150	78.00€
AE310146E	60-200	120-270	150	105.00€



**AE310150**

63.00€

Saca poleas



**AE310172**

720.00€

Juego de sacas

Composición:

Saca de 2ton

Piernas cortas: 85mm

Piernas largas: 185mm

Saca de 6ton

Piernas cortas: 140mm

Piernas largas: 280mm

Cilindro de 30ton



**AE310180**

240.00€

Juego de saca rótulas con accesorios ajustables

Apertura: 20; 22; 24; 27 y 30mm



**AE310183**

102.00€

Extractor barra de dirección



**AE320023**

35.00€

Compresor de grapas para amortiguadores

Apertura: 270mm



**AE320044**

54.00€

Compresor de grapas para amortiguadores

Apertura: 300mm



**AE320034**

455.00€

Juego de extractor de grapas MacPherson



**AE320035**

134.00€

Herramienta para fijación MacPherson



**AE300154B**

100.00€

Refratómetro

Aparato apto para comprobar líquido de baterías, líquido refrigerante y AdBlue



**AE300168**

96.00€

Verificador de fugas da la cabeza del cilindro

Equipo para comprobar las fugas en la combustión.

La utilización de líquido contrastante permite comprobar la existencia de dióxido de carbono en el depósito del líquido de refrigeración, denunciando así la existencia de fugas en la combustión.



**AE300168-1**

35.00€

Líquido para verificador da la cabeza del cilindro

Botella de 250ml

AE300201

105.00€

**Pistola tornado pulverizador**

Dimensiones: 330x105x270mm  
 Capacidad copo: 1l  
 Peso: 780g  
 Ruido: 85dB  
 Alimentación: 6,2bar  
 Consumo de aire: 56,6l/min  
 Entrada de aire: 1/4"



AE300202

99.00€

**Pistola tornado pulverizador/ espuma**

Dimensiones: 330x105x260mm  
 Capacidad copo: 1l  
 Peso: 950g  
 Ruido: 70dB  
 Alimentación: 6,2bar  
 Entrada de aire: 1/4"  
 Consumo de aire: 56,6l/min



AE300204

20.00€

**Jeringa para líquidos**

Hecho de plástico resistente al líquido de frenos y anticongelante  
 Permite succión, adición y la visualización del fluido.  
 Capacidad: 200cc  
 Peso: 294g

NO utilizar con combustibles

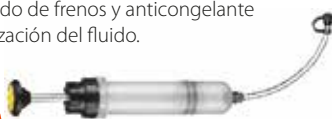

AE300205

45.00€

**Jeringa para líquidos**

Hecho de plástico resistente al líquido de frenos y anticongelante  
 Permite succión, adición y la visualización del fluido.  
 Capacidad: 1,5l  
 Peso: 900g  
 Aplicación: aceite caja velocidades y diferencial

NO utilizar con combustibles



AE300211

78.00€

**Jeringa para líquidos con 5 adaptadores**

Hecho de plástico resistente, aplicable a todos los tipos de aceites y combustibles. Permite succión, adición y la visualización del fluido.  
 Capacidad: 1,5l



AE300206

13.40€

**Base recoge de aceites para latas 20/ 30l**

Diseñado para la recogida de los restos de aceite filtros, nuevos o usados, y otros envases (enchufe directo en latas de 20/ 30l)  
 Hecho de polietileno de alta densidad resistente

Capacidad: 3l  
 Peso: 500g  
 Diámetro: 350mm



AE300207

44.00€

**Base recoge de aceite para bidones 200l**

Diseñado para la recogida de los restos de aceite filtros, nuevos o usados, y otros envases (enchufe directo en la parte superior de los bidones de 200l)  
 Hecho de polietileno de alta densidad resistente

Capacidad: 20l  
 Peso: 1 700g  
 Diámetro: 600mm



AE300215

33.00€

**Pistola de limpieza de motores**

Boquilla ajustable  
 Capacidad: 1l  
 Consumo de aire: 160 l/m  
 Entrada de aire: 1/4"  
 Presión de trabajo: 5-8 Bar



AE300220

65.00€

**Escurreedor de residuos de aceite**

Dimensiones: 174x197x486mm  
 Capacidad: 2l



AG010034

5.70€

**Bolígrafo magnético**

Longitud: 580mm



AG010035

18.50€

**Dedo magnético con luz y espejo**



**AG010164**

32.00€

Imán flexible con luz y espejo  
Luz: blanca, azul y UV



**AG010046**

7.50€

Punta para válvulas de los neumáticos  
Longitud: 230mm



**AG010159**

4.90€

Salida para manguera de aire de los neumáticos



**AG010059**

24.00€

Juego de 4 saca casquillos  
Medidas: 6; 8; 10 y 12mm



**AG010059**

Saca casquillos

Ref.	Medida (mm)	Precio
AG010059-6	6	5.70€
AG010059-8	8	5.70€
AG010059-10	10	6.20€
AG010059-12	12	6.20€

**AG010036**

7.00€

Bandeja magnética redonda



**AG010111**

22.50€

Bandeja magnética rectangular



**AS-0065**

30.80€

Soporte magnético para máquina de impacto y 4 llaves



**AG010049**

8.00€

Juego de 5 saca tornillos



**AG010099**

27.00€

Llaves de cruz para tuercas de ruedas  
Medidas: 17; 19 y 21mm



**AG010225**

24.50€

Llave de ruedas con 3 piezas  
Posibilidad de utilización en + o en "T"  
Medidas: 17; 19 y 21mm



**AG010109**

16.00€

Troncha tuercas

Medidas: 12-18 y 16-22mm



**AG010118A**

19.50€

Llave de apriete angular 1/2"



**AG010147**

11.50€

Llave de apertura angular con boquilla 1/2"



**AG010208**

52.50€

Juego de quitar tornillos torx dañados con 8 piezas

Composición:

Medida (mm)	Longitud (mm)	Hex (mm)
3	38	10
4	38	10
5	38	10
6	38	10
7	38	12
8	38	12
10	38	14
12	38	14



**AG10001SP-W** 7.50€

Destornillador macho extensible

Medidas: M4 a M12



**AG10002SC-W** 5.00€

Destornillador macho extensible

Medidas: M3 a M12



**AH020002** 20.00€

Protección guardabarros con fijación magnética

Dimensiones: 1 050x650mm



**AI010006** 22.00€

Herramienta para bloquear poleas y ruedas dentadas



**AI010009** 21.50€

Herramienta para la limpieza de las ranuras de los segmentos

Con 3 cuchillas circulares para limpieza de pistón (diámetro: 51 a 127mm)

Cuchilla 1: 1/16"; 5/64"; 3/32"; 1/8"; 5/32" y 3/16"

Cuchilla 2: 2; 2,5; 3; 4; 4,5mm y 1/4"

Cuchilla 3: 1,2; 1,5; 1,8; 2,8; 5 y 5,5mm

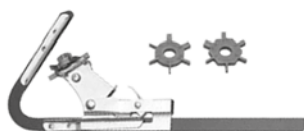

**AI010023** 10.60€

Tensor de correas del motor



**AI010029** 65.00€

Extractor de engranajes y poleas



**AI010030** 76.00€

Llave para bloquear polea y árbol de levas



**AI010037** 81.50€

Kit comando de motores con 8 piezas

Composición:

Marca	Modelo	Aplicación
OPEL	Astra Vectra	G 1.7 TD; 2.0 16V 1.8; 2.0 16V >1995
OPEL	Astra Vectra Zafira	G 1.4; 1.6; 1.8 16V 1.6; 1.8 16V 1.6; 1.8 16V

Árbol de levas a la derecha

SAAB	900 - 9000	
OPEL	Calibra Cavalier Omega-B Sintra Vectra	2.5; 2.5L; 2.6 V6 2.5L V6 2.5; 2.5L; 2.6 V6 2.5; 2.6; 3.0; 3.2; V6 3.0 V6 2.5L; 2.6 V6

Árbol de levas a la izquierda

SAAB	900 - 9000	
OPEL	Calibra Cavalier Omega-B Sintra Vectra	2.5; 2.5L; 2.6 V6 2.5L V6 2.5; 2.5L; 2.6 V6 2.5; 2.6; 3.0; 3.2; V6 3.0 V6 2.5L; 2.6 V6

ROVER

25	1.4; 1.6; 1.8VVC
45	1.4; 1.6; 1.8
75	1.8
200	VI
214	1.6V
216	1.6V; Cabrio; Coupé
218	Coupé
414	1.6V
416	1.6V; BRM 1.8VVC

VOLKSWAGEN

Bora	1.9 TDI
Golf	1.9 TDI
Lupo	1.2; 1.4; 3.0 TDI
Polo	1.4 TDI
Passat	1.9 TFI

CITROËN

Berlingo	1.9 D
Jumper	1.9 D; TD-FSO 1.9D;
Jumpy	1.9 D/TD
Synergie	1.9; 2.0 T
Xantia	1.9; 2.0 D; TD; HDI
Xsara	1.9; 2.0 D; TD; HDI

FIAT

Ducato	2.0 D
Ulysse	1.8; 2.0 Turbo

FORD

La mayoría de los motores diesel

PEUGEOT

205	1.6; 1.8; 1.9 D
305	1.6; 1.8; 1.9 D
306	1.8; 1.9 D; TD
309	1.6; 1.9 D
405	1.6; 1.9 D
406	1.9 D
605	2.0 D; TD
806	1.9 D
Boxer	1.9; 2.0 D; TD
Expert	1.9 D
Partner	1.9 D

TALBOT

Express	D
Horizon	D-J5D
Solara	D

ISUZU

Motores Diesel	1.5; 1.7
----------------	----------

OPEL

Motores Diesel	1.6; 1.7
Motores Gasolina	1.2; 1.4; 1.6; 1.8; 2.0

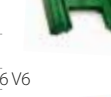

**AI010041**
**98.00€**
**Kit comando de motores con 19 piezas**

Composición:

Marca	Modelo	Motorización
CITROËN	Synergie	2.0/Turbo; ZX 1.9D/TD
	Xantia	1.9D/TD
	Berlingo	1.9D
FIAT	Ulisses	2.0/Turbo
	Ducato	2.0
FORD	Fiesta	1.25; 1.4 (95-); 1.8-XR2i/RS1800 16V
	Mondeo	1.6; 1.8; 2.0 16V (93-)
	Escort/Orion	1.6; 1.8i 16V (92-)
HONDA	Accord/Prelude	2.3i (93-);
	Prelude	2.2 V-Tec; motor SOHC
	Accord	1.8, 2.0; 2.2 (-93); 2.0i (93-)
	Shuttle	2.2i;
	Civic	1.6 VTI
	Accord	(90-)
	Prelude	2.0 16V (-90)
LAND ROVER	Discovery MPI	2.0 16V (93-), motor 20T4
MAZDA	121	1.25
OPEL	Cavalier	2.5
	Calibra	2.5
	Vectra	2.5
	Omega	2.5; 3.0
	Sintra	3.0
	Astra	1.8; 2.0 16V
	Cavalier	2.0 16V
	Calibra	2.0 16V/Turbo
	Omega-B	1.6 16V
	Motor Gasolina OHC	1.2; 1.4; 1.6; 1.8; 2.0
	Motor Diesel OHC	1.6D i; 1.7D
	Motor Diesel OHC	
	Diesel Isuzu	1.5D i; 1.7D
	205; 305; 309; 405	1.6; 1.9
	405	1.8; 2.0 (92-)
	605	2.0
	Boxer	2.0
	205; 305	1.8; 1.9D
	306	1.8; 1.9D/TD
309	1.8; 1.9D; 1.8TD	
405	1.8TD; 1.9D	
406	1.9D	
Partner	1.9D	
Talbot/Horizon/Solara	1.9D	
J5/Talbot Express	1.9D	
605	1.9D/TD	
806	1.9TD	
Expert	1.9D	
Boxer	1.9D/TD	
RENAULT	R5	1.6D
	R9	1.6D
	411	1.6D
	Express/Extra	1.6D - motores Diesel F8M
	Clio; Express/Extra	
	R19	1.9D - motor diesel F8Q
	Espace	2.1D
	R21	2.1D
	R25	2.1D
	Trafic/Master	2.1D - motor Diesel J8S
	Clio	1.2; 1.4
	Express/Extra	R19 1.4
	Megane/Scenic	1.4; 1.6 - motor E7F/E7J
	R5	1.7
	Clio	1.7; 1.8
	R19	1.7
	R21	1.7
	Megane/Scenic	2.0
	Laguna	1.8; 2.0
Trafic	1.7 - motor F3N; F3P; F2R	
Clio Williams; R19; Megane	2.0 16V - motor F7P; F7R;	
Laguna/Safrane	2.0 16V - motor N7Q/N7U	
ROVER	623	(93-)
	618/620	motor SOHC (93-)
	216; 416	GTi 16V (-95) motor D16A9, motor K16 DOHC; motor SOHC 820 8V (m8) GTa/GTi 16V K16 (-95)
	Metro	
	214; 414	K16(89-)
	216; 416	K16 (95-)
	MGF	1.8 MPI/VVC (95-)
	220	M16 (-92)
	220	Turbo T16 (92-)
	420	M16 (-92)
	420	T16 (92-)
	320	Turbo M16 (-91)
	620	Ti (94-)
820	Turbo T16 Vitesse (91-)	
SAAB	900	2.5
	9000	3.0 V6
VW; AUDI; SEAT; SKODA		TDI desde 2000 ECOTEC 1.4; 1.6; 1.8; 2.0 16V

**AI010060**
**57.00€**
**Juego de 4 llaves para inyectores 1/2"**

Composición:

	Faces	Diámetro (mm)	Medida (mm)
A	6	22	110
B	12	22	75
C	12	27	78
D	12	28	78

**AI010060-A**
**15.40€**
**Llaves para inyectores 1/2"**

 Caras: 6  
 Diámetro: 22mm  
 Medida: 110mm

**AI010060-B**
**13.30€**
**Llaves para inyectores 1/2"**

 Caras: 12  
 Diámetro: 22mm  
 Medida: 75mm

**AI010060-C**
**12.30€**
**Llaves para inyectores 1/2"**

 Caras: 12  
 Diámetro: 27mm  
 Medida: 78mm

**AI010060-D**
**12.80€**
**Llaves para inyectores 1/2"**

 Caras: 12  
 Diámetro: 28mm  
 Medida: 78mm

**AI010063A**
**50.00€**
**Medidor de la tensión de correas distribución**

**AI010086**
**115.00€**
**Juego de 12 llaves para terminales**

**AI010092**

65.00€

Bloqueo para el volante del motor



**AI010104**

32.00€

Herramienta para quitar la tapa del depósito combustible

Ajustable entre 122-199mm



**AI010127**

4.50€

Llave extractora de correa trapezoidal

Aplicación: VOLVO y grupo VAG



**AI010137**

40.00€

Organizador de piezas desmontadas



**AI010166**

8.20€

Llave torx para polea alternador 1/2"

Medida: T50

Longitud: 110mm



**AI010167**

8.20€

Llave XZN para polea alternador 1/2"

Medida: M10

Longitud: 110mm



**AI010176**

38.00€

Llave para quitar el filtro de combustible

Esta herramienta hace que sea rápido y fácil de realizar la reducción del riesgo de daños en la carcasa de plástico del filtro.

Composición:

Marca	Modelo	Aplicación
CHEVROLET	Captiva, Epica	2.0 VCDi
CITROËN	Hdi Relay	2.0; 2.2; 2.8; 3.0
FIAT	500; Doblo; Strada;	1.3 JTD
	Idea; Panda; Punto	
	Idea; Multipla; Punto;	1.9 JTD
	Sedici (+2.0 JTD)	
	Ducato	2.0; 2.2; 2.3; 2.8; 3.0 JTD
LANCIA	Musa; Ypsilon	1.3 MJTD
OPEL	Agila; Astra; Corsa;	1.3 CDTi
	Combo; Meriva; Tigra	
	Astra; Signum; Vectra;	1.9 CDTi
	Zafira	
PEUGEOT	Boxer	2.0; 2.2; 2.8; 3.0 HDI
SAAB	9-3	1.9 TiD
SUZUKI	Splash; Swift; SX4	1.3 DDiS



**AI010195**

95.00€

Llave para tensar correas con 10 piezas



**AI020015**

19.00€

Extractor para válvulas

Capacidad: 60-120mm

Altura: 150mm



**AI0200**

Alicate para segmentos

Ref.

Capacidad (mm)

Precio

<b>AI020019</b>	115-180	23.50€
<b>AI020020</b>	70-108	20.00€
<b>AI020021</b>	50-100	18.50€



**AI020024**

69.50€

Extractor para válvulas

Para grandes motores/ diesel



**AI020025**

58.50€

Extractor para válvulas

Capacidad: 55-175mm



**AI020027**

29.00€

Desarmador de válvulas universal con gancho

Compresor del muelle de válvulas

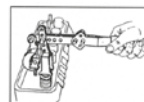

**AI020048**

Cinta para segmentos

Ref.

Capacidad (mm)

Altura (mm)

Precio

<b>AI020048A</b>	57-125	127	12.50€
<b>AI020048D</b>	90-175	100	13.90€
<b>AI020048E</b>	90-175	165	24.00€





**AI020043**

16.50€

Alicate para fuelles de mordazas



**AI020049**

65.00€

Alicate universal para válvulas



**AI020051**

204.00€

**Kit prueba de presión de aceite en motores de diesel**  
BMW, CITROËN, DACIA, DAF, DAIHATSU, FIAT, FORD, ISUZU, LAND ROVER, MAZDA, MERCEDES, MITSUBISHI; NISSAN, OPEL, PEUGEOT, RENAULT, ROVER, SEAT, TOYOTA, VOLKSWAGEN, VOLVO

Manómetro: 0-70bar  
Diámetro: 80mm  
Turbo: 400mm



**AI020052**

128.00€

**Kit prueba de presión de aceite en motores de gasolina**

Incluye adaptadores y reparadores con rosca  
Medidas: M10; M12; M14 y M18



**AI020054**

134.00€

**Kit prueba de presión de aceite**

Incluye adaptadores y reparadores con rosca  
Manómetro: 0-10bar  
Turbo: 1 300mm  
Juego de 10 adaptadores



**AI020056A**

19.00€

Alicate para retenes de las válvulas



**AI020066**

64.50€

Kit tenaza para segmentos con cinta

Apertura: 73-111mm



**AI020092**

75.00€

Extractor de tornillos dañados

Juego de brocas/ extractor y guías para la remoción de tornillos dañados  
Gama: 5 a 16mm



**AI020101A**

109.00€

**Dipositivo de comprobación de inyectores common rail diesel**

Este dispositivo permite medir de forma rápida y eficiente la cantidad de combustible de retorno de cada inyector, y por tanto verificar, si hay algún fallo. Permite la medición de hasta 6 inyectores al mismo tiempo. Incluye adaptadores para inyectores Bosch, Delphi, Denso y Siemens.



**AI020107**

145.00€

**Herramienta de ajuste del punto de inyección**

Permite el ajuste del punto de inyección en motores diesel con bomba de inyección de combustible convencional.

Aplicable entre otros vehículos ALFA ROMEO, AUDI, BMW, FIAT, FORD, ISUZU, IVECO, LANCIA, LAND ROVER, MITSUBISHI, NISSAN, RENAULT, ROVER Y VOLKSWAGEN.



**AI020109**

64.00€

Juego de 6 llaves para velas de incandescencia

Composición/ medidas (mm):

Llaves: 8; 9; 10; 12; 14 y 16  
Longitud: 160mm



**AI020131**

108.00€

Compresor de grapas de válvulas

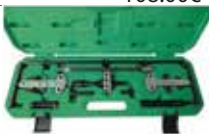

**AI020142**

339.00€

Extractor para rodamientos pequeños

Composición/ medidas (mm):

Extractor

Barra

Expansores: 6 a 8; 8 a 10; 12 a 15 y 15 a 18



**AI020162**

18.50€

Alicate de puntas rectas para quitar relés



**AI020163**

19.10€

Alicate de puntas angulares para quitar relés



**AI020178**

289.00€

Kit para quitar bujías de precalentamiento dañadas



**AI020180**

110.00€

Test de sistemas turbo

Este kit por la insuflación de aire comprimido de baja presión en el sistema del turbo, permite la verificación de fugas.

Composición: 4 pares de adaptadores

Ø	Medida (mm)
55-60	64
65-70	74
75-80	84
85-90	94



**AI020184S**

37.00€

Juego de 3 llaves 1/2" para la línea de inyección

Composición:

Ref.	Medida (mm)	Aplicación
AI020184A	14	BMW; VW
AI0200184	17	Mercedes 100, 130, 314, 360, 360h, 352A, 346/355, 401, 402, 403, 407h, 615, 616 e 617
AI0200184AB	19	Mercedes 314, 352, A, 346/355, A, 401, 402/422, LA, 403, 407



**AI020185**

15.70€

Llave estrella abierta plegada

llave especial para desmontar las tuberías del sistema de combustible de alta presión en los motores diesel

Medidas: 17x17mm



**AI020205**

112.00€

Extractor de inyectores (diesel/ gasolina)

Extractor especialmente concebido para la retirada de inyectores diesel y gasolina. Las garras son intercambiables lo que permite abarcar un mayor número de tipo de inyectores.



**AI030007**

16.50€

Juego de 5 piezas para raspar, limpiar y quitar juntas



**AI050043S**

19.50€

Juego de 3 raspadores

Medidas: 15; 20 y 30mm



**AI030010** 3.60€

Herramienta para pulir válvulas grandes



**AI030011** 3.40€

Herramienta para pulir válvulas pequeñas



**AI030020** 16.70€

Endoscopio de mecánico



**AI030025** 5.70€

Juego de piezas rascar/quitar retenes y juntas



**AI030027** 40.00€

Juego de 6 rascadores con mango



**AI040007** 10.50€

Alicate para segmentos

Medidas: 1,2 a 6,3mm



**AI040008** 83.50€

Kit completo para prueba de vacío y purga de frenos



**AI040031** 112.00€

Bomba para vacío y presión con kit de purga de frenos

Selección de la válvula de control para la función de vacío o presión.



**AI040011** 13.50€

Alicate de bujías con puntas aisladas



**AI040017** 49.00€

Juego de alicates para clips de cabezas intercambiables



**AI040018** 16.70€

Alicate para abrazaderas



**AI040060** 25.00€

Alicate para tubos de combustible

Alicate para conexiones rápidas de tubos de combustible.



**AI050001** 14.00€

Llave de filtros de aceite de 3 brazos

Capacidad: 60-120mm



**HC**

Llaves de copa para filtros



Ref.	Caras (mm)	Medida (mm)	Precio
HC-78/15	15	78	4.50€
HC-65/67	14	65-67	4.00€
HC-65/14	14	65	4.50€
HC-68/14	14	68	4.00€
HC-74/15	15	74	4.20€
HC-66/6	6	66	4.00€
HC-76/8	8	76	4.50€
HC-73/14	14	73	4.20€
HC-74/76	15	74-76	4.50€
HC-75/77	15	75-77	4.50€
HC-76/12	12	76	4.50€
HC-76/30	30	76	4.50€
HC-93/36	36	93	4.50€
HC-76/14	14	76	4.50€
HC-108/15	15	108	4.50€
HC-108/18	18	108	4.50€
HC-65103		65-120	14.00€
HC-106/15	15	106	4.50€
HC-100/15	15	100	4.50€
HC-86/16	16	86	4.50€
HC-90/15	15	90	4.50€
HC-80/82	15	80-82	4.50€
HC-92/10	10	92	4.50€
HC-93/45	45	93	4.50€
HC-93/15	15	93	4.50€
HC-86/18	18	86	4.50€
HC-80/15	15	80	4.50€
HC-96/18	18	96	4.50€
HC-95/15	15	95	4.50€
HC-9.5mm	adaptadores 1/2"-3/8"		1.70€

**AI050004**

45.00€

Juego de 15 piezas de copa para filtros

Composición:

Caras	Medidas (mm)	Aplicación
14	65	GM, DAIHATSU, TOYOTA
14	65-67	DAIHATSU
14	68	MAZDA, FORD ESCORT, SUBARU
14	73	TOYOTA, LEXUS
15	74-76	SATURN
15	75-77	VW, AUDI, FORD, ISUZU, MERCEDES, OPEL
14	76	VW, PORSCHE, MERCEDES, BMW, AUDI A3, OPEL
30	76	FORD
15	80	NISSAN, HONDA, MAZDA, ISUZU, SUBARU, OPEL, TOYOTA
15	80-82	MAZDA, SUBARU, TOYOTA, HONDA, ACURA, NISSAN
15	90	HONDA ACCORD, MITSUBISHI, ISUZU
15	93	OPEL, MAZDA, VOLVO, MITSUBISHI, NISSAN, VW, PORSCHE, RENAULT, FORD, HONDA, AUDI
36	93	FORD
15	100	ISUZU, MITSUBISHI

Adaptador 1/2" (F)x3/8" (M)



**AI050004A**

110.00€

Juego de 30 piezas de copa para filtros

Composición:

Caras	Medida (mm)	Aplicação
14	65	GM, DAIHATSU, TOYOTA
14	65-67	DAIHATSU
14	68	MAZDA, FORD ESCORT, SUBARU
14	73	TOYOTA, LEXUS
15	74	AUDI, GM, ROVER, CHRYSLER
15	74-76	SATURN
15	75-77	VW, AUDI, FORD, ISUZU, MERCEDES, OPEL
8	76	FIAT MAREA, LANCIA DELTA
12	76	FIAT (DUCATO, SCUDO, ULYSSE), RENAULT (MEGANE, LAGUNA, ESPACE)
14	76	VW, PORSCHE, MERCEDES, BMW, AUDI A3, OPEL
30	76	FORD
15	78	NISSAN, FORD, TOYOTA
15	80	NISSAN, HONDA, MAZDA, ISUZU, SUBARU, OPEL, TOYOTA
15	80-82	MAZDA, SUBARU, TOYOTA, HONDA, ACURA, NISSAN
16	86	Volvo (S40, S60, S70, S80)
18	86	VW (GOLF TDI, PASSAT/TDI), AUDI A6 TDI, RENAULT (CLIO, RAPID 1.9D, LAGUNA, SAFRANE, ESPACE 2.1D, CITROEN; PEUGEOT
15	90	HONDA ACCORD, MITSUBISHI, ISUZU
10	92	FIAT (CINQUECENTO, COUPE, CROMA, PANDA, REGATA, RITMO, SEICENTO, TEMPRA, TIPO), LANCIA (BETA, DEDRA, KAPPA, THEMA)
15	93	OPEL, MAZDA, VOLVO, MITSUBISHI, NISSAN, VW, PORSCHE, RENAULT, FORD, HONDA, AUDI
36	93	FORD
45	93	VW AUDI (2.4; 2.6; 2.8L)
15	95	TOYOTA, ALFA, GM, FORD, CHRYSLER
18	96	AUDI (A4, A6TDI), VW (PASSAT 97 TDI), RENAULT (LAGUNA 2.2D, SAFRANE 2.2D, ESPACE 2.2D, R19, RAPID, MEGANE 1.9/2.1D)
15	100	ISUZU, MITSUBISHI
15	106	FIAT DUCATO 2.5 TD
18	108	RENAULT (ESPACE, LAGUNA, MASTER, SAFRANE, TRAFFIC 2.4; 2.5; 2.8D)

Llave filtro de aceite ajustable 65-120  
Adaptador 1/2"(F)x3/8"(M)



**AI030002**

25.50€

Juego de 11 llaves para tapones de aceite

Capacidad: 45-110mm



**AI050009A**

7.30€

Llave de filtros de aceite



**AI050022**

9.00€

Llave de filtros de aceite

Ajustable: 60-90mm



**AI050024**

20.00€

Juego de 4 palancas

Medidas: 200; 330; 540 y 600mm



**AI050037**

16.50€

Llave de filtros de 3 patas

Capacidad: 45-110mm



**AI050040**

8.00€

Llave para tapón

Medidas: 8 y 10mm



**AN010009A**

6.70€

Llave para cárter multiple

Medidas (mm): 10; 11; 12; 13; 14; 15 y 17mm

Longitud: 150mm



**AN010030**

11.20€

Alicate para quitar pesos de la rueda



**AI050042**

15.00€

Llave para cambio de ventiladores

Medidas: 8 y 10 mm

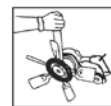

**AI050043**

17.00€

Alicate de presión para filtros de aceite

Medida: 53-118mm



**AI050076**

51.50€

Llave de filtros ajustable 1/2"

Medida: 60-80mm



**AI050077**

15.70€

Llave de correa para filtros

Medida: 25-160mm



**AI050080**

8.00€

Llave para tornillos de culata do motor 1/2"

Medida: M9

Longitud: 100mm



**AI05009**

Llave de bujes larga 3/8"

Ref.	Medida (mm)	Longitud (mm)	Precio
<b>AI050092</b>	14	250	12.3€
<b>AI050093</b>	16	250	13.80€



**AI050096**

64.50€

Juego de 7 llaves especiales

Sensores de vacío y de oxígeno

Válvulas de presión estática



**AI050102**

66.50€

Llave de filtros 3 brazos auto ajustable

Capacidad: 95-165mm



**AI010033**

9.50€

Llave para sensor de oxígeno



**AI050104**

16.10€

Llave para sondas de oxígeno

Medida: 22mm



**AI050109**

41.50€

Llave magnética para tapón

Longitud: 350mm

Filtros: 60 a 105mm



**AI050113**

170.00€

Juego de puntas impacto de 3/4" y 1"

Composición/ medidas (mm):

- 5 Llaves torx T60, T70, T80, T90 y T100 (107mm)
- 4 Llaves hexagonales 17, 19, 22 y 24mm (107mm)
- 4 Llaves torx E18, E20, E22 y E24 (107mm)
- 1 Llave 6 caras 3/4" 22mm
- 1 Llave 6 caras 1" 22mm
- 1 Llave hexagonal en L 4mm



**AI050152**

17.50€

Tubo para descarga de aceite usado en el alojamiento del filtro



**AI050152A**

11.30€

Tubo para descarga de aceite usado en el alojamiento del filtro

Aplicación: TOYOTA y LEXUS



**AI050176**

160.00€

Kit para montaje de correas acanaladas con 11 piezas

Composición:

Marca	Modelo
AUDI	A3
BMW	118/ 120/ 318/ 325/ 330/ 335/ 520/ 525/ 530/ 535/ 635/ 720/ 730/ X3/ X5
CITROËN	C2/ C3/ C4/ Jumper/ Relay
CHRYSLER	Grand Voyager/ Voyager
FIAT	Albea/ Doblo/ Ducato/ Fiorino/ Marea/ Multipla/ Qubo/ Linea/ Palio/ Siena/ Stilo y Strada
FORD	C-Max/ Courie/ Fiesta/ Focus C-Max/ Fusion/ Mondeo/ Tourneo/ Transit
IVECO	Daily
LANCIA	Lybra
MAZDA	2/ 3/ 5/ Axela
MERCEDES	Sprinter/ Viano/ Vito
MITSUBISHI	ASX
PEUGEOT	206/ 207/ 307/ Boxer
SEAT	Altea/ Ibiza
SKODA	Octavia/ Yeti
VOLKSWAGEN	EOS/ Golf/ Passat/ Polo/ Sirocco
VOLVO	C30/ S40/ V50



**AI050191**

11.00€

Llave magnética para los enchufes



**AI050192**

32.50€

Embudo universal para aceite

Presilla de fijación embudo: 28-74mm



**AI060006**

6.70€

Reparación de "roscas" alojamiento de bujías

Medida: 14mm



**AI060020**

3.60€

Calibre de espesores (galgas) con 20 láminas

Medidas (mm): 0,05; 0,10; 0,15; 0,20; 0,25; 0,30; 0,35; 0,40; 0,45; 0,50; 0,55; 0,60; 0,65; 0,70; 0,75; 0,80; 0,85; 0,90; 0,95 y 1

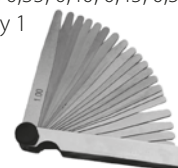

**AI060030**
**165.00€**

Kit de reparación de las roscas de alojamiento de velas con 56 piezas

**AI060031**
**120.00€**

Kit reparador de roscas con 87 piezas

Composición:

Medidas:

Helicoides:

25x M6x1.0x1.5 (9mm)

25x M8x1.25x1.5 (12mm)

25x M10x1,5x1,5 (15mm)

Macho:

M6x1.0

M8x1.25

M10x1.5

Punzón:

M6x1.0

M8x1.25

M10x1.5

Broca:

6,3mm

8,3mm

10,4mm

Mango:

M6x1.0

M8x1.25

M10x1.5



**AL010006**
**26.50€**

Juego de 3 alicates

Para conexiones rápidas de tuberías de combustible

**AL010011**
**18.30€**

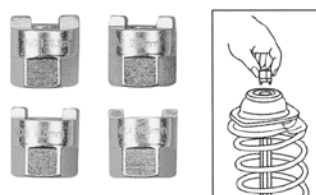
Llave para tuercas suspensión (copelas)

**AN010001**
**45.00€**

Kit de herramienta para frenos neumático con 11 piezas

Para sangrar y girar los pistones de freno

**AN010001C**
**60.00€**

Kit de herramienta para frenos neumático con 18 piezas

Para sangrar y girar los pistones de freno

**AN010001D**
**150.00€**

Kit de herramienta para frenos neumático

Para sangrar y girar los pistones de freno

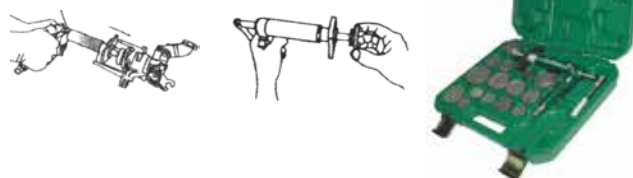
**AL010006**
**26.50€**

Juego de 3 alicates

Para conexiones rápidas de tuberías de combustible

**AN010033**
**4.20€**

Extractor de bujes

**AN010085A**
**12.30€**

Herramienta para colocar válvulas neumáticas

**AN010038**
**7.00€**

Extractor selladores

**AN010045**
**8.20€**

Separador de rótulas



**AN010049** 10.50€

Centrador de embrague universal



**AN010063** 54.50€

Alicate centrador de embrague universal



**AN010065** 59.00€

Juego de 4 pinzas para cilindros de freno



**AN010081A** 20.50€

Alicate de muelles de frenos



**AN010066** 40.50€

Kit de desmontaje del embrague del compresor A/C

Aplicable en diversas marcas de compresores A/C



**AN010054A** 20.50€

Juego de 3 alicates para tuberías de goma



**AN010054N** 19.00€

Alicate de presión para tuberías



**AN010068** 5.40€

Limpiabornes y terminales de batería



**AN010072** 27.00€

Reparación de roscas interno y externo

Medidas de las roscas: 0,8; 1; 1,25; 1,50; 1,75; 2 y 3mm



**AN010072C** 15.70€

Reparador de roscas SAE (pulgadas)

Medidas de las roscas: 9"; 10"; 16"; 20"; 27"; 28" y 32"



**AN010091A** 81.50€

Extractor para rótula axial de dirección



**AN010092** 42.00€

Llave excéntrica para rótula axial de dirección

Medida: 33-42mm



**AN010106A** 43.50€

Alicate corta tubos de escape

No se puede utilizar tubos de acero inoxidable

Medidas: 19 a 76mm de diámetro



**AN010112** 17.50€

Adaptador para desmontaje de semi ejes





**AN010131** 15.80€

Rodillo prensador para neumáticos

**AN010137** 68.00€

Alicate para tapones de bujes de ruedas

**AN010186B** 540.00€

Kit para embrague auto ajustable y bimasa

**AN010188**

Palanca para desmontaje de ruedas



Ref.	Medida (mm)	Precio
AN010188A	500	17.70€
AN010188C	200	3.90€

**AN010225** 525.00€

Herramienta para instalar/ quitar rodamiento manga eje

Permite profesionalidad, rapidez, seguridad y poco esfuerzo en la tarea

Aplicación: PEUGEOT, CITROËN y RENAULT

**AN010226** 15.00€

Medidor de espesor de los discos de freno y profundidad base neumáticos

Discos de freno: 0-60mm

Material: aluminio

**AG010205** 18.50€

Medidor digital de profundidad

Utilizado para medir la profundidad del suelo de los neumáticos y de las pastillas de freno.

Especificaciones:

Gama de medición: 0-25,4mm

Resolución: 0,01mm

Display: LCD

Medición en milímetros o pulgadas.

Utiliza pilas SR44/ LR44 de 1,4V (no incluidas).

**AN010272** 14.00€

Alicate para tapas plásticas hembras de la rueda

Permite retirar las tapas plásticas de las hembras de la rueda sin dañar las llantas.

**AN020006** 8.00€

Llave para clips de zapatas

**AN020007** 26.50€

Pulidora de cilindros

Medida: 51-177mm

**AN020007-1** 11.00€

Juego de 3 piedras para pulidora de cilindros

Aplicable a despolidor AN020007

**AN020022** 26.90€

Juego de pulidora de cilindros

Composición/ medidas (mm):

Medida: 18-89

Piedras: 19; 28,8 y 51

Juego de piedras de reemplazo

**AN020022**

Juego de piedras para pulidora de cilindros

Ref.	Medida (mm)	Unidades	Precio
AN020022-A	51	3	7.50€
AN020022-B	28,8	3	6.00€
AN020022-C	19	3	5.10€
AN020022-D	28,8	2	4.90€

**AN040035A**

14.00€

Corta tubos



**AN040043A**

52.00€

Juego de cortar tubos y abocardador

Composición/ medidas (mm):

Fijador de tubos: 4; 4,75; 6; 8; 10; 12 y 14

Punzones abocardador: 4; 4,75; 6; 8 y 10



**AN040082**

110.00€

Juego quita tuercas dañadas con 9 piezas 3/8"

Medidas: 10; 11; 12; 13; 14; 15; 16; 17 y 19



**AN040101**

6.70€

Punta 1/2" pentagonal para frenos



**AN040168**

343.00€

Juego de herramienta para instalar/ quitar rodamientos de rueda

Permite profesionalidad, rapidez, seguridad y poco esfuerzo en la tarea

Para rodamientos: 60 a 85mm



**AR020018**

19.50€

Comprobador de presión

Manguera flexible con adaptador: 14 y 18mm

Escalas: 0-300psi; 21kg/cm<sup>2</sup>; 21bar y 2 100kpa



**AR020019**

21.00€

Comprobador vacío y bomba combustible



**AR020053A**

207.00€

Kit de accesorios eléctricos/ electrónicos auto



**AR030013**

3.70€

Hidrómetro para baterías líquidas



**AR030034**

5.20€

Punta pruebas circuitos entre 3-48V

Indicación de polaridad mediante Leds



**AR030041**

57.50€

Juego de 7 aplicadores de juntas

Composición/ medidas (mm):

14,4-16; 15,9-17,5; 17,5-19,1; 20,7-22,4;

24-26; 25,5-27,5 y 30,3-32,3



**AR030047**

22.00€

Test fluido de frenos



**AR030062**

37.00€

Test de atuadores

Este equipo permite la prueba a componentes electrónicos que actúen por campos magnéticos y electromagnéticos.



**AR040043**

14.80€

Extractor terminales de los cables de la batería e limpa parabrisas

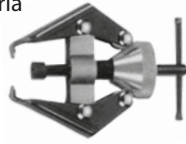

**AR040016**

78.00€

Juego de cables de arranque de la batería 500 Amp

Dimensiones: 0.3x268x12mm  
Longitud: 3 600mm



**AR06002A**

19.00€

Alicate para abrazaderas - matriz "+"



**AR060003**

12.50€

Alicate para abrazaderas - matriz "V"



**AR060008**

15.00€

Alicate para abrazaderas de filtros combustible tubos de evacuación



**AR060011**

9.50€

Dispositivo para el bloqueo de tuberías



**AR060020**

11.10€

Alicate para quitar tubos



**AR060021**

40.40€

Alicate para abrazaderas VAG



**AR060024A**

154.00€

Kit de 7 alicates para abrazaderas



**AN010177B**

55.00€

Alicate especial para abrazaderas de fuelle



**AR060029**

47.00€

Montador de fuelles



**AR060032**

15.50€

Kit de adaptadores para desacoplamiento de tubos A/C



**AR060043**

99.00€

Juego de 52 piezas para eliminación de radios

Aplicación:  
Marca Auto: AUDI; BMW; FIAT; FORD; SKODA;  
MERCEDES; OPEL; PORSCHE y VOLKSWAGEN  
Marca Radio: Becker; Blaupunkt; Clarion; JVC;  
Grundig; Kenwood; Panasonic; Pioneer y Sony



**AR060055**

22.50€

Alicate de abrazaderas de tubos  
Apertura de 22 a 55mm

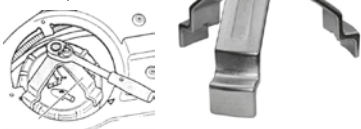

**Herramienta - aplicación especial por MARCAS  
GRUPO BMW y MINI**
**AI010121**
**56.00€**
**Llave para boya de depósito de combustible**

 Aplicación: AUDI, BMW, MERCEDES,  
PORSCHE y VOLKSWAGEN

**AI010139**
**103.00€**
**Herramienta desmantelador del sensor de nivel de combustible**

Aplicación: BMW y MINI

**AL010099**
**220.00€**
**Kit comando del motor diesel BMW**

Modelo	Motorización
E34/ E36/ E38/ E39/ E46/	M41/ M51/ M47TU/ M47T2/
E53/ E60/ E61/ E63/ E65/	M57TU/ M57T2
E66/ E70/ E83/ E87/ E90/ E91/	
Land Rover	2.5DT/ 3.0TD6/
Freelander	2.0TD4

**AL010128**
**48.50€**
**Kit comando del motor BMW**

Modelo	Motorización	Año
118d	E87	2003-2007
120d	E87	2003-2007
318d/td	E46 E90/91	2000-2008
320d/crd	E46 E90/91	1997-2008
325d	E90/91/92/93	2006-2010
330d/xd/crd	E46 E90/91/92/93	1998-2008
510d	E39 E60/61	1999-2010
525d/xd	E39 E60/61	1999-2010
530d/xd	E39 E60/61	1998-2010
535d	E60/61	2004-2010
635d	E63/64	2004-2010
730d	E38 E65/66	2003-2007
X3 2,0d	E83	2003-2007
X3 3,0d	E83	2003-2010
X5		

**AI010115**
**23.00€**
**Extractor de bombas inyectoras BMW**

Modelo	Motorización
318D/ 320D/TD/ 330D	E46
525D/ 530D	E39
525D/ 530D/ 535D	E60/E61
730D	E38
X5 3,0D	E53

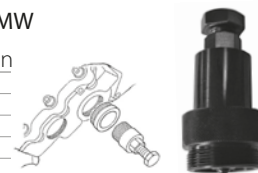
**AI050071S**
**299.00€**
**Juego de 8 llaves especiales BMW**

**FIAT y OPEL**
**AL010044**
**157.00€**
**Kit comando del motor FIAT/ OPEL**

Marca	Modelo	Motorización	Año	Piezas nº
FIAT	Panda/ Idea/ Doblo	1.3JTD MultiJet	2004-2007	7; 8; 9; 10
		1.7D/ 1.9D/ TD/ JTD2.4		1; 3; 4
		1.9/ 2.4JTD 16V/ 20V		2; 3; 4; 5; 6; 7
OPEL	Agila/ Corsa/ Astra H/ Tigra B/ Meriva/ Astra/ Vectra/ Signum/ Zafira	1.3CDTI	2004-2007	7; 8; 9; 10
		1.9CDTI	2004-2006	2; 3; 4; 5; 6; 7
ALFA ROMEO	147/ 156	1.9JTD 16V/ 2.4JTD 20V		2; 3; 4; 5; 6; 7

**AL010196**
**47.00€**
**Kit comando del motor gasolina**

Marca	Modelo	Motorización
ALFA ROMEO	159	939A4.000
CHEVROLET	Aveo/ Cruze/ Orlando	
FIAT	Croma	939A4.000
OPEL	Astra G/ Astra H/ Corsa D/ Meriva A/ Zafira B/C/ Vectra C/ Signum/ Insignia	Z16LEL/ Z16LER/ Z16LET/ Z16ZE1/ Z16XEP/ Z16ZER/ LLu/ A16LET/ A16XEL/ 2HO/A18XEL/ 2HO/A18XE R/Z18XER



**Herramienta - aplicación especial por MARCAS  
FORD, MAZDA y VOLVO**
**AL010070**
**21.50€**
**Kit comando del motor FORD/ PEUGEOT/ CITROËN**

Marca	Modelo	Motorización
FORD	Fiesta/ Fusion	1.4TDCI
	Focus/ Focus C-Max	1.6TDCI
	Fusion/ Fiesta	1.6TDCI
CITROËN	C4	1.6HDI
PEUGEOT	206	1.4HDI
PEUGEOT	307	HDI

**AL010071**
**77.20€**
**Kit comando del motor FORD**

Modelo	Motorización	Año
Fiesta	1.8D Turbo	
Focus		
Focus C-Max	1.8TDCI	
Tourneo Connect	1.8TDDI/ TDCI	
Transit Connect	1.8TDDI/ TDCI	2002-2006

**AL010107**
**69.00€**
**Kit comando del motor FORD**

Modelo	Motorización diesel
Fiesta	1.8TDDI/ TDCI
Focus	Turbo
Transit	
Transit Connect	

**AL010175**
**28.50€**
**Pin de fijación árbol de levas**

Marca	Modelo	Motorización	Año
FORD	Fiesta/ Fusion	1.4TDCI	2002>2009
	Focus C-Max	1.4/ 1.6TDCI	
	Mondeo	2.0TDI/ TDCI/ 2.2TDCI	
	Transit	2.0TDI/ TDCI/ 2.4TDI/ TDCI	
VOLVO	S40/ V50	1.6D/ 1.9D	

**AL010205**
**8.00€**
**Kit comando del motor FORD/ MAZDA/ VOLVO**

Marca	Modelo	Motorización
FORD	C-Max/ Cougar/ Fiesta/ Focus	HWDA/ HWDB/ CSDA/ QQDA/ QQDB/ QQDC/ AODA/ AODB/ DBA/C/ EDBB/ EDBD/ F8JA/ F8JB/ FUJA/ FUJB/ M7JA/ M7JB/ FXJA/ FX JB/ FYJA/ FYJB/ N4JB/ FHA/ FHE/ L1T/ L1V/ ASDA/ ASDB/ FXDA/C/ FXDB/D/ FYDA/C/ FYDB/D/ EYDB
	MAZDA	6
VOLVO	C-30/ S40/ S80/ V50/ V70	B4164S3/ B4184S11/ B4204S3

**AL010218**
**137.00€**
**Kit comando del motor FORD**

Modelo:  
Fiesta/ Fusion/ Focus/ C-Max/ B-Max/ S-Max/ Mondeo/ Galaxy

**AN040286**
**320.00€**
**Extractor de silentblocks**

Marca	Modelo	Año
FORD	Focus I	1998-2005
	Focus II	2004-2008
	CB4	2008-2011
MAZDA	3	2003-2008
	3	2009->
	5	2005-2010



Herramienta - aplicación especial por MARCAS  
MERCEDES

AI010114

28.00€

Juego de herramientas para airbag



AI010097

16.40€

Llave hexagonal 1/2" especial para SCANIA y MERCEDES

Longitud: 27mm



AI010116

42.00€

Extractor de bujías de incandescencia

Motorización: 611/ 612/ 613

Longitud: 10mm



AI020113

138.00€

Juego para extracción de inyectores  
common rail MB

Motorização:

OM 611/ OM 612/ OM 613



AI020186

53.00€

Juego saca boquillas inyectores

Modelo

Motorización

Clase C/ Clase E/

108CDI/ 110CDI 16V/ 112CDI 16V/

Sprinter

C220CDI 16V/ E200CDI 16V



AI050071S

299.00€

Juego de 8 llaves especiales MB

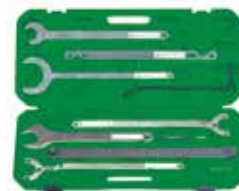

AI050085A

15.00€

Llave de filtros de 14 caras con 74mm

Nota: utilizando una llave con la caja de 27 mm, se debe aplicar una fuerza máxima de 25Nm. Si se aplican fuerzas superiores, se corre el riesgo de dañar la llave de filtros.

Marca:

MERCEDES/AUDI A3/ BMW E36/ CITROËN/

FIAT/ FORD/ LANCIA/ MAZDA/ NISSAN/

OPEL/ PEUGEOT/ PORSCHE/ RENAULT/

TOYOTA/ VOLKSWAGEN Golf IV



AL010057

125.50€

Llave bloqueador del cigüeñal MB



AN040126

191.00€

Herramienta para desmontaje de silentblokes  
eje trasero MB



## Herramienta - aplicación especial por MARCAS GRUPO PSA - PEUGEOT/ CITROËN

**AI010136**
**96.00€**

### Kit comando del motor HPI (gasolina) y HDI (diesel) PEUGEOT/ CITROËN

Marca	Modelo	Motorización	Año
PEUGEOT	206/ 307/ 406	1.8 16V	2000-2004
	607/ 806/ 807	2.0 16V	2002-2005
	Expert		
CITROËN	C4/ C5	1.8/ 2.0HPI	2002-2005
	Xsara	2.0 16V	2002-2005
	Xsara Picasso	1.8/ 2.0 16V	2002-2005
	Evasion/ C8 Jump		

Códigos motor: 6FZ (EW7J4)/ FRN (EW10J4/L4/5)/ RLZ (EW10D)

**AL010041**
**155.00€**

### Kit comando del motor HPI (gasolina) y HDI (diesel) PEUGEOT/ CITROËN

Marca	Modelo	Motorización	Año	
CITROËN <i>Diesel</i>	Visa/ BX/ ZX/ Xantia/ Xsara/ Synergie/ C15/ Berlingo/ Dispatch/ C25/ Relay	1.7/ 1.8/ 1.9/ D/ TD	1984-2002	
	Saxo/ AX/ Xsara	1.5D	1994-2007	
	Xsara/ Berlingo/ Dispatch 1.9D		1998-2007	
	Xsara/ Xsara Picasso/ Xantia/ C5/ Synergie/ Berlingo/ Dispatch/ Relay	2.0HDI	1998-2007	
	C4	2.0HDI	2004-2008	
	C5	2.2HDI	2000-2004	
	C8	2.0/ 2.2/ HDI	2002-2007	
	Relay	2.5D/ TurboD	1994-2002	
	XM/ Xantia/ Dispatch/ Synergie/ Evasion	2.1D/ 2.2D/ TD	1994-2002	
	CITROËN <i>Gasolina</i>	AX/ Xsara/ AX GTi/ Saxo/ ZX/ Berlingo	1.0/ 1.1/ 1.4/ 1.6	1994-2004
		C2/ C3/ C3 Pluriel/ Berlingo	1.0/ 1.1/ 1.4	2002-2007
		Saxo/ Xsara	1.6 16V	1997-2006
		C2/ C3 Pluriel/ C4	1.6	1997-2006
		Xsara/ Xantia	1.8 16V	2002-2008
		ZX/ Xsara	2.0 16V	1996-2000
		Synergie/ Evasion/ Relay/ Jumper	2.0 Turbo	1994-2002
		Xsara	2.0 16V	2000-2004
Xsara/ C5/ Xsara Picasso		2.0HPI/ 2.0 16V/ 1.8	1999-2002	
Xsara/ C5/ Xsara Picasso		2.0HPI/ 2.0 16V/ 1.8	2002-2008	
PEUGEOT <i>Diesel</i>	205/ 305/ 405/ Partner/ 306/ 309 Talbot Horizon/ Solara Express	1.8/ 1.9/ D/ TD	1982-2001	
	206/ 307	1.4 HDi	2001-2008	
	206/ 306/ Express/ Partner	1.9D	1998-2007	
	206/ 306/ 307/ 406/ 806/ 807	2.0HDI/ 2.0HDI 16V	1997-2007	
	307/ 307 CC/ 407	2.0HDI	2003-2008	
	406/ 607	2.2HDI	2002-2007	
	406/ 806/ Expert/ Boxer	1.9D/ TD	1994-2002	
	406/ 605/ 806	2.1D Turbo	1994-2002	
	PEUGEOT <i>Gasolina</i>	106/ 205/ 306/ 307/ 405/ Partner	1.0/ 1.1/ 1.4/ 1.6	1993-2008
		206	1.1/ 1.4/ 1.6	1998-2008
		205/ 309/ 306/ 405/ 806/ 605/ 406/ Partner/ Boxer	1.6/ 1.9/ 1.8/ 2.0	1989-2002
		206/ 307	1.6 16V	2000-2008
		306/ 407	1.8 16V	1999-2002
206/ 307/ 406/ 406 Coupe/ 607/ 806		2.0 16V	1998-2000	
306/ 406		1.8 16V	1995-1998	
306/ 406		2.0 16V	1994-2001	
306/ 406		1.6/ 2.0 Turbo	1994-2001	
406		1.8 16V	2000-2004	
406/ 406 Coupe/ 607	2.2 16V	1998-2008		
807	2.0 16V	2002-2005		

**AL010175**
**28.50€**

### Pin de fijación árbol de levas

Marca	Modelo	Motorización
CITROËN	C1/ C2/ C3/ Xsara	1.4HDI
	C3/ C4	1.6HDI
PEUGEOT	107/ 206/ 207	HDI
	307	1.4/ 1.6HDI

**AN040100**
**6.50€**

### Vaso pentagonal para frenos PSA



## RENAULT, NISSAN y DACIA

**AL010038**
**17.00€**

### Kit comando del motor RENAULT/ NISSAN

Marca	Modelo	Motorización
RENAULT	Modus/ Laguna/ Kangoo/ Clio	1.5dCI/ 1.9dCI
NISSAN	Almera/ Micra	1.5dCI

**AL010190**
**47.00€**

### Kit comando del motor

Marca	Modelo	Motorización	Año	
RENAULT	Clio	1.2/ 1.4/ 1.6		
	Clio Sport	2.0		
	Espace	2.0		
	Scenic	1.4/ 1.6/ 1.8/ 2.0		
	Scenic II	1.4/ 1.6/ 2.0		
	Grand Scenic II	1.4/ 1.6		
	Laguna	1.8/ 2.0		
	Laguna II	2.0		
	Megane	1.4/ 1.6/ 1.8/ 2.0		
	Megane II	1.4/ 1.6/ 2.0		
	DACIA	Logan	1.4/ 1.6	
		Sandero	1.4/ 1.6	
NISSAN		Micra		2003>2008
	Almera		2002>2006	
	Note		2006>2008	
	Qashqai		2007>2008	
<i>Diesel</i>		1.2/ 1.4/ 1.6/ 1.8 (8v-16v)/ 2.0iDE/ 2.0Turbo		

Códigos motor: D4F/ K4J/ K4M/ K7M/ K9K/ F4P/ F3R/ F4R/ F5R/ F4RT



**Herramienta - aplicación especial por MARCAS GRUPO VAS - AUDI, VOLKSWAGEN, SKODA, SEAT y PORCHE**

**AI010069**

19.50€

**Llave bloqueadora del cigüeñal (VW)**

Para bloquear el cigüeñal cuando se desea cambiar la correa u otros componentes

Modelos: Bora/ Golf/ Lupo/ Polo TDI's



**AI020154**

235.00€

**Instalador sellado cigüeñal VOLKSWAGEN**

Marca	Modelo	Año
AUDI	A3	2004>
	A4	
SKODA	Octavia2/ Roomster/ Fabia	
VOLKSWAGEN	Golf	2004>
	Transporter T5/ Caddy/ Touran	2004>



**AI050079**

11.00€

**Llave bujía caja de velocidades y transmisiones 1/2"**

Marcas: AUDI y VOLKSWAGEN

Llave estriada XZN Tamperproof M16



**AL010029**

27.30€

**Herramienta de alineación doble árbol levas motores gasolina**

Marca	Modelo	Motorización
AUDI	A2	1.4/ 1.6
SEAT	Arosa/ Ibiza/ Cordoba/ Toledo/ Leon/ Inca	1.4/ 1.6
SKODA	Fabia/ Octavia	1.4/ 1.6
VOLKSWAGEN	Lupo/ Polo/ Golf/ Bora/ Beetle/ Caddy	1.4/ 1.6



**AL010053A**

53.00€

**Kit comando del motor**

Marca	Modelo	Motorización	Año
VOLKSWAGEN	Polo	1.2 6V/ 12V	2002>
SEAT	Ibiza	1.2 6V	2002>
SKODA	Fabia	1.2 6V/ 12V	2003>



**AL010072**

6.40€

**Kit comando del motor**

Marca	Modelo
AUDI	A4/ S3/ A6/ TT
SEAT	Ibiza/ Cordoba/ Leon/ Toledo/ Alhambra
SKODA	Octavia
VOLKSWAGEN	Golf/ Bora/ Beetle/ Passat



**AL010087**

169.70€

**Kit comando del motor AUDI**

Marca	Modelo	Motorización
AUDI	A4	3,2FSI
	A6	2,4
	A6	2,4quattro
	A6	3,2FSI A)
	A8	3,2FSI A



**AL010088**

64.00€

**Kit comando del motor a gasolina**

Marca	Modelo	Motorización
AUDI	A3	1.4L/ 1.6 FSI
SKODA	Octavia	
VOLKSWAGEN	Polo/ Golf/ Golf Plus/ Jetta/ Passat/ Touran	



**AN010202**

22.00€

**Llave de impacto especial XZN 3/4" para bujes de las ruedas AUDI/ VOLKSWAGEN**

Medida: M18

Longitud: 105mm



**AN010202B**

10.80€

**Llave de impacto XZN 1/2" AUDI/ VOLKSWAGEN**

Especialmente diseñado para apretar los tornillos que sujetan el eje trasero

Medida: M18

Longitud: 78mm



**AI010108**

19.50€

**Regulador tensor del rodillo**

Marca	Modelo
AUDI	A4/ A6/ Cabrio
SEAT	Ibiza
SKODA	Superb
VOLKSWAGEN	Polo/ EOS/ Passat





**AL010110**
**170.00€**
**Juego sincronizar motor - grupo VAG**

Marca	Modelo	Motorización	Año
AUDI	A3	1.6FSI	2003-2006
	A3/ S3	1.8Turbo	1996-2003
	A4/ A6	1.8Turbo	1994-2006
	Cabriolet		1997-2000
SEAT	TT	1.8Turbo	1998-2006
	Ibiza	1.8Turbo	1999-2002
	Cordoba	1.8Turbo	
	Leon	1.8Turbo	1999-2005
SKODA	Toledo	1.8Turbo	1999-2005
	Octavia	1.8Turbo	1996-2005
	Octavia 20V RS	1.8Turbo	2000-2005
VOLKSWAGEN	Golf	1.6FSI	
	Touran	1.6FSI	
	Beetle	1.8Turbo	1999-2006
	Golf/ Bora	1.8Turbo	1997-2005

**AL010202**
**6.00€**
**Pin fijación cigüeñal - grupo VAS**

Esta llave es equivalente a la herramienta VAG T10340

Marca	Modelo	Motorización
VOLKSWAGEN	Polo/ Golf/ Golf VI	1.4/1.6TSI/FSI
	Cabrio/ Golf Plus/	
	Golf Variant/ Touran/ EOS/	
	Passat/ Jetta/ Scirocco/	
	Beetle/ Sharan/ Tiguan/	
	Caddy/ Caddy Maxi/ Fox	
AUDI	A3	1.4/1.6TSI/FSI
SEAT	Cordoba/ Ibiza	1.4/1.6TSI/FSI
SKODA	Fabia/ Roomster	1.4/1.6TSI/FSI



Códigos de motor: AWY/ AXU/ AZQ/ BAG/ BBM/ BKG/ BLF/ BLG/ BLN/ BLP/ BMD/ BME/ BMY/ BTS/ BWK/ BZG/ CAVA/ CAVB/ CAVC/ CAVD/ CAXA/ CEVA/ CGPA/ CGPB/ CHFA

**AL010203**
**6.00€**
**Pin fijación cigüeñal - grupo VAS**

Esta llave es equivalente a la herramienta VAG T400690

Marca	Motorización
AUDI/ SEAT/ SKODA/ VOLKSWAGEN	2.4/ 3.2FSI/ 3.0 V6 TDI/ 4.2 V8 TDI/ 1.4/ 1.6 TSI/FSI

Código de motor: BGP/ BGQ/ CBUA/ CBTA

**AL010225**
**70.00€**
**Kit comando del motor VOLKSWAGEN**

Modelo	Motorización	Año
Transporter	2.4TD4	1995>2003
Código de motor: AAB/ AJA		
Transporter	2.5TDI	1995>2003
Código de motor: ACV/ AHY/ AJT/ AUF/ AXG/ AXL/ AYC		
Crafter	2.5TDI	2006 >2012
Código de motor: BJJ/ BJL/ BJL/ BJM		

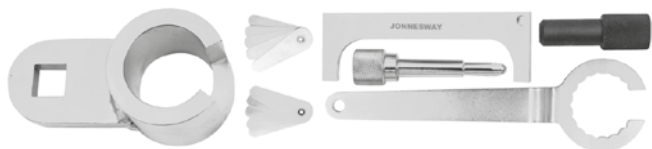
**ME010001**
**345.00€**
**Juego de guías para sellar la horquilla**

Composición:

Ref. Longitud (mm)

**329-01** 449/50

**329-02** 45

**329-03** 43

**329-04** 41

**329-05** 39

**329-06** 35/36

**329-07** 48

**329-08** 54

**329-09** 46/47

**ME010007**
**22.60€**
**Llave montaje/ desmontaje de horquilla invertida**

**ME010009**
**9.30€**
**Extractor de raspador de suspensión**

**ME010010**
**16.00€**
**Juego de guías para bujes suspensión**

Composición/ medidas (mm):

12,5; 14; 16 y 18

**ME010012**
**26.80€**
**Guía montaje/ desmontaje de horquilla invertido**

**ME020001**
**29.90€**
**Extractor de cojinete de eje de dirección**

Apertura: 30-68mm

**ME020002**
**50.50€**
**Herramienta para montaje de cojinete de dirección**

**ME020003** 245.00€

Extractor de cojinete de volante (manillar)



**ME020005** 72.10€

Guía para montaje de cojinete de dirección



**ME020006** 211.00€

Dispositivo de compresión para instalación dos avances



**MG010001** 26.80€

Extractor de buje del embrague/ polea alternador



**MG01000**

Llave hembra de embrague

Ref.	Medida (mm)	Pin	Precio
MG010002	34x59	2	17.00€
MG010003	41x59	2	17.00€
MG010004	39x72	2	19.60€
MG010005	46x72	2	19.60€
MG010006	46	3	19.60€



**MG010008** 25.00€

Herramienta de muelles de embrague

Para motores 50 a 250cc con polea de  $\varnothing$ 125 a 155mm



**MG010009** 33.00€

Herramienta de muelles de embrague

Para motores 50 a 250cc con polea de  $\varnothing$ 125 a 155mm



**MG020001** 30.00€

Corta cadena

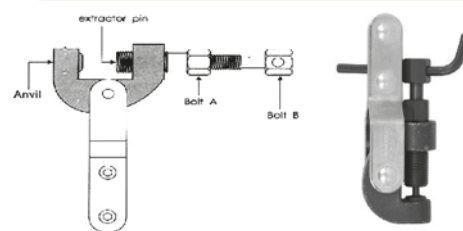

**MG020003** 67.00€

Corta/ remachadora de cadena



**MG020004** 10.00€

Alicata para argolla de unión



**MG020006** 13.40€

Extractor de argolla de unión



**MG020007** 48.40€

Kit de limpieza para cadena



**MG020008** 12.40€

Cepillo limpia rodillos



**MI010014** 18.60€

Extractor válvulas motor



**MI010016** 39.20€

Removedor/instalador del pin del pistón

Medidas (mm):

Pistones: 40 a 100  
Pin: 12 a 25



**MI010017**

19.00€

Instalador de segmentos del pistón



**MI010018**

17.50€

Protector en aluminio para tornillo de banco



**MI010019**

154.50€

Herramienta de separar el cigüeñal



**MI010020**

22.70€

Soporte cigüeñal



**MI010021**

20.00€

Extractor de avance



**MI020001**

10.50€

Llaves para jets 6 y 8mm



**MI020002**

16.00€

Juego de llaves para carburadores FCR



**MI020004**

22.00€

Escalímetro de carburadores



**MN020004**

6.50€

Protector de llantas



**MN020005**

4.10€

Desmontador de neumáticos



**MT010001**

7.70€

Fijador del cable del embrague y del freno

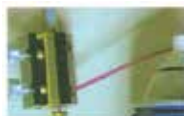

**MT010002**

40.00€

Herramienta perforación hembra y tornillo de seguridad



**MT010003**

113.00€

Caballete rueda trasera



**MT010004**

104.00€

Soporte central universal



**MT010005**

19.50€

Herramienta retención universal



**MT010006**

21.50€

Soporte polea



**MT010007**

31.90€

EZ-ROLL



**MT010008**

8.00€

Gancho para muelles



**AB010001** 39.50€

Kit de 10 piezas para colocación de cristales



**AB010002** 67.00€

Herramientas para quitar parabrisas



**AB010002-A** 13.00€

Bobina de alambre para retirar cristales - 15m



**AB010017** 16.50€

Cuchillo para-brisas



**AB0100**

Hoja de acero para recambio

Ref.	Medida	Precio
AB010018	3/4"	1.70€
AB010019	1"	1.60€
AB010020	1-1/2"	1.60€



**AB010026S** 27.50€

Kit quita tapizados de plástico



**AB010041** 38.00€

Juego de 12 llaves para extracción paneles



**AB010042** 142.00€

Espejo con luz auxiliar para reparación de abolladuras



**AB010043** 52.00€

Espejo auxiliar para reparación de abolladuras



**AB020002** 17.50€

Ventosa simple para cristales



**AB020003** 42.50€

Ventosa doble para cristales



**AB020009** 39.20€

Ventosa doble articulada para cristales

Estructura en aluminio  
Ventosas: ø115mm



**AB020010** 59.00€

Triple ventosa para cristales

Estructura en aluminio  
Ventosas: ø123mm  
Capacidad: 35 kg/100 kg



**AB020015** 6.50€

Juego de ventosas para cambio de cristales



**AB020019** 34.50€

Juego de 6 ventosas  
Para ayudar a encolar cristales, etc



**AB030014** 8.40€

Herramienta para colocación de gomas de cristales



**AB030028** 3.90€

Llave quita grapas



**AB030041** 4.20€

Llave quita grapas



**AB030043** 4.30€

Llave quita grapas



**AB030046** 4.20€

Llave quita grapas



**AB030047** 3.30€

Llave quita grapas



**AB030048** 6.00€

Llave quita grapas



**AB030060** 37.00€

Juego de 2 alicates para grapas de plástico



**AB030068A** 26.50€

Palanca de chapista

Medida: 380mm



**AB030068C** 34.00€

Palanca de chapista

Medida: 900mm



**AB030068D** 30.00€

Palanca de chapista

Medida: 750mm



**AB030068F** 19.00€

Palanca de chapista

Medida: 450mm



**AB030069A** 19.60€

Cuña de chapista

Medida: 125mm



**AB030069B** 25.20€

Cuña de chapista

Medida: 137mm



**AB030069C** 11.50€

Cuña de chapista

Medida: 92mm



**AB030069E** 7.00€

Cuña de chapista

Medida: 48mm



**AB030070B** 19.80€

TAS de cuña simple



**AB030070C** 17.00€

TAS abombado



**AB030070D** 23.40€

TAS de coma

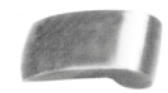

**AB030089** 124.00€

Juego de 7 TAS de chapista para aluminio en polietileno de alta densidad



**AB030100** 52.00€

Martillo para aluminio con accesorios



**AB030071** 31.00€

Martillo de boca redonda dentado para recoger



**M10110** 21.50€

Martillo de boca redonda y punta plana



**M10210A** 18.00€

Martillo de boca plana redonda y punta curva



**M10210B** 17.00€

Martillo de boca plana redonda y plana derecha



**M10410A** 23.00€

Martillo de boca redonda plana y cuadrada para encaje picotado



**M10410B** 23.50€

Martillo de boca redonda plana y cuadrada para encaje picotado



**AG010023** 9.90€

Base para lija en plástico ABS

Dimensiones: 106x212mm



**AG010024** 27.00€

Soporte flexible para lima de chapista

Para limas de 355mm



**AG010024**

Lima para AG010024

Ref.	Sierra	Longitud	Precio
AG010024-1	9	14"/355mm	27.00€
AG010024-2	12	14"/355mm	32.00€



**AG010030A**

Juego de martillos y TAS



140.00€

**AG010185**

Alicate de rebordear



84.00€

**AG010055**

Destornillador de golpe con accesorios



19.50€

**AG010055-B**

Juego de 4 puntas para AG010055

Composición:

Fenda: 8 y 10mm

Philips: PH2 y PH3

2.50€

**AE310003**

Juego saca abolladuras



79.50€

**AE330004**

Garra de chapista una dirección

Capacidad: 3t



65.00€

**AE330005**

Garra de chapista dos direcciones

Capacidad: 2t (transversal)

3t (longitudinal)



65.00€

**AE330008**

Garra de chapista dos direcciones

Capacidad: 2t (empuje transversal)

3t (empuje recto)



51.00€

**AE330009**

114.00€

Garra de chapista tipo alicate una dirección  
Capacidad: 3t



**AE330013**

120.00€

Garra de chapista dos direcciones  
Capacidad: 3t (transversal)  
5t (longitudinal)



**AE330015**

214.00€

Garra de chapista dos direcciones de dos puntos  
Capacidad: 5t



**AE330016**

41.50€

Gancho para unir a la cadena  
Capacidad: 6t



**AE330030**

79.50€

Punto fijo de empuje  
Capacidad: 5t



**AE330034**

157.00€

Pinza de chapista de posición variable hasta 90°  
Capacidad: 5t



**AE330035**

85.00€

Pinza de chapista  
Capacidad: 5t



**AG010138**

19.00€

Destornillador de golpe con accesorios



**AG010138-B**

6.00€

Juego de 13 puntas para AG010138

## Chapista

**AG010140**

11.00€

Mini TAS universal



**AG010141**

55.00€

Cinzel para chapista con puntas intercambiables



**AG010142**

51.00€

Martillo cinzel para chapista con puntas intercambiables



**AG010143**

56.00€

Cinzel con botadores y cortafrios intercambiables



**AL010113** 30.00€

**Llave de 1/2" para girar el cigüeñal**

Aplicación: SCANIA

**AL010114** 42.00€

**Llave de 1/2" para alinear el cigüeñal**

Aplicación:

Marca Motorización

MERCEDES 6.8/ 10 cilindros

MAN 12 cilindros

**AL010116** 50.00€

**Llave de 11 dientes para alinear el cigüeñal**

Medida: Tornillo hexagonal de 24mm

Aplicación: DAF 65CF/ 75CF/ 85CF/ 95XF/ CF75/ CF85/ F65/ F75/ F85/ F95/ XF95

**AL010117** 28.00€

**Llave de 1/2" para alinear el cigüeñal**

Aplicación: DAF XF105 euro

**AN010187** 160.00€

**Alicate para correas de freno**

Aplicación: VOLVO

**AI010153** 18.00€

**Llave sensor de posición con 8 caras de 1/2"**

No utilizar con máquinas neumáticas

Medida: 27mm

Longitud: 60mm

Aplicación: MERCEDES Actos/ série SK/ MAN/ SCANIA

**AI020164** 28.00€

**Llave para girar válvula electromagnética con 8 caras de 3/4"**

Medida: 38mm

Longitud: 100mm

Aplicación: SCANIA

**AI050135** 130.00€

**Juego de llaves de copa para filtros - pesados**

Composición:

Llave 6 caras 36mm

Llave 15 caras 74mm

Llave 15 caras 106mm

Llave 15 caras 107mm

Llave 15 caras 108mm

Llave 18 caras 108mm

Llave 18 caras 135mm

Llave de cinta Ø 160mm

Llave 21mm

**AI050172** 143.00€

**Llave de filtros ajustable de 1/2"**

Medida: 104-150mm

**AN010235** 58.50€

**Llave hembra de 3/4" para montaje/desmontaje embrague**

Diámetro interno: 64mm

Diámetro externo: 79mm

Aplicación: SCANIA

**AN010237** 115.00€

**Extractor para articulaciones tirante de freno**

Haldex

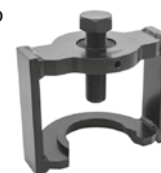
**AN040062** 31.00€

**Llave de montaje/desmontaje inyectores**

Aplicación: SCANIA/ MERCEDES/ MAN

**AN040066** 157.00€

**Saca rótulas**

Medida: 39mm

Aplicación: SCANIA/ MERCEDES/ MAN/ HINO

**AN040105** 133.00€

**Llave para rueda trasera con 8 caras de 1"**

Medida: 100mm

Aplicación: SCANIA

**AN040200** 102.00€

**Saca cubo para rueda frontal de 1"**

Medida: 80mm

Aplicación: SCANIA

**AG01016**
**Llave de rueda doble**

Ref.	Medida (mm)	Diámetro barra (mm)	Precio
AG010168	30x32	19 com 600	44.00€
AG010169	32x33	19 com 600	43.50€





**AI050110**

44.00€

Llave de cadena para filtros

Longitud de cadena: 520mm

Filtros: 60-165mm

**AN04005**

Llave para quitar el tapón del buje de la rueda trasera



Ref.	Medida (mm)	Precio
AN040055	111	125.00€
AN040056	120	125.00€

**AB030076**

Grapas de plástico

Ref.	Cantid. Embl.	Precio
AB030076-01	300	17.00€
AB030076-02	300	17.00€
AB030076-03	200	17.00€
AB030076-05	150	14.80€
AB030076-06	150	14.80€
AB030076-07	200	17.00€
AB030076-11	200	17.00€
AB030076-13	200	17.00€
AB030076-14	100	18.00€
AB030076-15	100	18.00€
AB030076-17	100	18.00€
AB030076-18	200	17.00€
AB030076-20	200	17.00€
AB030076-21	100	18.20€
AB030076-24	100	18.20€
AB030076-26	100	21.50€
AB030076-27	100	21.50€
AB030076-28	100	21.50€
AB030076-30	100	18.00€
AB030076-32	100	18.00€
AB030076-34	200	31.20€

**AB030076-00**

66.00€

Juego de 21 tipo de muelles con 20 piezas cada uno

Caja de plástico

**AI020158**

85.00€

Juego de 150 anillas de cobre para inyectores con 15 medidas

Composición:

 13,85x7,3x1,4; 14,60x7,5x1,3; 14,60x7,5x3,0; 15x7x2;  
 15x7,5x1; 15x7,5x1,5; 15x7,5x2; 15x7,5x2,5; 15x7,5x3;  
 15,5x7,5x2; 16x7,5x1,5; 16x7,5x1,7; 16x7,5x2; 16x7,4x2  
 y 20x9,4x0,9

**AR030022**

59.00€

Juego de 530 terminales automóvil con 18 tipos

**AR030024**

29.80€

Juego de 270 juntas para los sistemas A/C

Composición:

 4,47x1,78; 5,28x1,78; 6,07x1,78; 6,80x1,90; 7,65x1,78;  
 8x2; 8,80x1,90; 9,25x1,78; 10,82x1,78; 10,77x2,62;  
 12x2; 13x2; 13,95x2,62; 14x2; 15x2; 15,54x2,62;  
 17,17x1,78 y 20,22x3,53



# JONNESWAY®

Herramientas Profesionales

• Manuales • Neumáticas •

específicas para automóviles, motocicletas y vehículos pesados





**JONNESWAY®**

# Herramienta Neumática



Herramienta  
neumática

Accesorios  
para redes de  
aire comprimido



**JAI-1024**

160.00€

Máquina con llave de impacto de 1/2"

Características:

Rotación en vacío:	10 000rpm
Par trabajo:	510Nm
Par máximo:	570Nm
Longitud:	99mm
Peso:	1 400g
Consumo de aire:	127l/min
Presión operacional:	6,2bar
Ruido:	97dB



**JAI-1024-RK**

9.90€

Kit de reparación para JAI-1024

**JAI-1124**

172.00€

Máquina compacta de impacto de 1/2"

Máquina compuesta preparada para trabajo intensivo de 2 percutores y 3 velocidades de apriete y 1 velocidad de aflojamiento (máxima potencia). Portada de aleación de aluminio resistente.

Características:

Rotaciones en vacío:	9 500rpm
Par trabajo:	560Nm
Par máximo:	620Nm
Longitud:	112mm
Peso:	1 150g
Consumo del aire:	136l/min
Presión operacional:	6,2bar
Ruido:	99,9dB



**BREAKAWAY**

par 1 100Nm

**JAI-1124-RK**

11.50€

Kit de reparación para JAI-1124

**JAI-1114**

180.00€

Máquina con llave de impacto de 1/2"

Máquina compuesta preparada para trabajo intensivo con mecanismo de 2 percutores.

Características:

Rotaciones en vacío:	9 500rpm
Par trabajo:	745Nm
Par máximo:	935Nm
Longitud:	190mm
Peso:	2 300g
Consumo de aire:	207l/min
Presión operacional:	6,2bar
Ruido:	99,2dB



**JAI-1114-RK**

13.00€

Kit de reparación para JAI-1114

**JAI-1232K**

145.00€

Máquina para quitar bujías de incandescencia de 1/4" con kit de llaves

Interruptor de dirección de la máquina construida en el botón de encendido, lo que permite efectuar el cambio de dirección con una mano. 4 Posiciones ajustables para 20, 30, 40, y 45Nm.

Características:

Rotaciones en vacío:	11 000rpm
Par:	20-45Nm
Longitud:	180mm
Peso:	800g
Consumo del aire:	150l/min
Presión operacional:	6,2bar
Ruido:	102dB

Accesorios:

Llaves de vaso largas: 8; 9; 10; 11 y 12mm  
Cardán  
Extensión



**JAI-1232-RK**

12.50€

Kit de reparación para JAI-1232

**JAI-6202K**

190.00€

Máquina con llave de impacto de 1/2" con kit de vasos

Máquina con mecanismo pin clutch.

Características:

Rotaciones en vacío:	7 000rpm
Par trabajo:	516Nm
Peso:	2 700g
Tubo interior:	10mmø

Accesorios:

Llaves: 9; 10; 11; 13; 14; 17; 19;  
22; 24 y 27mm  
Extensión: 75mm  
Llave 6 caras: 4mm  
Kit de manutención  
Maleta



**JAI-6202-RK**

54.50€

Kit de reparación para JAI-6202

**JAI-0501K**

238.00€

**Máquina con llave de impacto de 1/2" con kit de llaves**

Máquina con mecanismo de 2 percutores.

Características:

Rotaciones en vacío: 7 000rpm  
 Longitud: 190mm  
 Peso: 2 660g  
 Tubo interior: 10mmø

Accesorios:

Llaves: 9; 10; 11; 13; 14; 17; 19;  
 22; 24 y 27mm  
 Extensión: 75mm  
 Llave hexagonal: 4mm  
 Kit mantenimiento  
 Maleta



**JAI-0501-RK**

17.50€

**Kit de reparación para JAI-0501**

**JAI-1054**

199.00€

**Máquina con llave de impacto de 1/2"**

Máquina para trabajo intensivo con mecanismo de 2 percutores.

Características:

Rotaciones en vacío: 8 000rpm  
 Par trabajo: 780Nm  
 Par máximo: 920Nm  
 Longitud: 186mm  
 Peso: 2 560g  
 Tubo interior: 13mmø  
 Consumo del aire: 119l/min  
 Ruido: 90dB



**JAI-1054-RK**

22.00€

**Kit de reparación para JAI-1054**

**JAI-0963**

221.00€

**Máquina con llave de impacto de 3/8"**

Máquina compuesta por mecanismo de 2 percutores.

Características:

Rotaciones en vacío: 11 500rpm  
 Par trabajo: 410Nm  
 Par máximo: 480Nm  
 Longitud: 146mm  
 Peso: 1 100g  
 Tubo interior: 10mmø  
 Consumo del aire: 127l/min  
 Ruido: 93,5dB



**JAI-0963-RK**

15.40€

**Kit de reparación para JAI-0963**

**JAI-6266**

80.00€

**Máquina con llave de impacto de 3/8" (10mm)**

Características:

Rotaciones en vacío: 10 000rpm  
 Par máximo: 102Nm  
 Peso: 1 100g  
 Tubo interior: 10mmø



**JAI-6266-RK**

3.50€

**Kit de reparación para JAI-6266**

**JAI-0926**

575.00€

**Máquina con llave de impacto de 3/4"**

Máquina compuesta con mecanismo de 2 percutores.

Características:

Rotaciones en vacío: 5 750rpm  
 Par trabajo: 1 350Nm  
 Par máximo (aperto): 1 148Nm  
 Par máximo (desaperto): 1 626Nm  
 Peso: 3 150g  
 Tubo interior: 13mmø  
 Consumo del aire: 195l/min



**JAI-0926-RK**

38.50€

**Kit de reparación para JAI-0926**

**JAI-0936**

562.00€

**Máquina con llave de impacto de 3/4"**

Máquina compuesta preparada para trabajo intensivo con mecanismo de 2 percutores.

Características:

Rotaciones en vacío: 6 500rpm  
 Par trabajo: 1 620Nm  
 Par máximo: 2 025Nm  
 Longitud: 225mm  
 Peso: 1 940g  
 Tubo interior: 13mmø  
 Consumo del aire: 190l/min  
 Ruido: 90,5dB



**JAI-0936-RK**

57.00€

**Kit de reparación para JAI-0936**



**JAI-6212K** 373.00€

**Máquina con llave de impacto de 3/4" con kit de vasos**  
Máquina con mecanismo pin clutch.

Características:

- Rotaciones en vacío: 4 800rpm
- Torque máximo: 1 086Nm
- Peso: 4 900g
- Tubo interior: 13mmø



Accesorios:



- Llaves: 26-38mm
- Extensión: 75mm
- Llaves 6 caras: 4 y 5mm
- Kit manutención
- Maleta

**JAI-6212-RK** 17.70€

Kit de reparación para JAI-6212

**JAI-6211** 355.00€

**Máquina con llave de impacto de 3/4" (19mm)**  
Máquina con mecanismo de 2 percutores.

Características:

- Rotaciones en vacío: 6 500rpm
- Par máximo: 1 016Nm
- Peso: 4 550g
- Tubo interior: 13mmø



**JAI-6211-RK** 32.00€

Kit de reparación para JAI-6211

**JAI-1206L** 775.00€

**Máquina con llave de impacto de 3/4"**

Máquina para trabajo intensivo con eje largo y mecanismo de 2 percutores.

Características:

- Rotaciones en vacío: 5 500rpm
- Par trabajo: 2 100Nm
- Par máximo: 2 300Nm
- Longitud: 465mm
- Peso: 6 400g
- Tubo interior: 19mmø
- Consumo del aire: 212l/min
- Ruido: 106dB



**JAI-1206L-RK** 53.00€

Kit de reparación para JAI-1206

**JAI-0938** 645.00€

**Máquina con llave de impacto de 1"**

Máquina compuesta para trabajo intensivo con mecanismo de 2 percutores.

Características:

- Rotaciones en vacío: 6 500rpm
- Par trabajo: 1 740Nm
- Par máximo: 2 150Nm
- Longitud: 230mm
- Peso: 4 100g
- Consumo del aire: 190l/min
- Presión operacional: 6,2bar
- Ruido: 190,5dB



**JAI-0938-RK** 55.50€

Kit de reparación para JAI-0938

**JAI-1138** 699.00€

**Máquina con llave de impacto de 1"**

Máquina de eje corto con mecanismo de 2 percutores.

Características:

- Rotaciones en vacío: 5 000rpm
- Par trabajo: 2 430Nm
- Par máximo: 2 712Nm
- Longitud: 346mm
- Peso: 8 200g
- Tubo interior: 19mmø
- Consumo del aire: 255l/min
- Ruido: 100dB



**JAI-1138-RK** 89.00€

Kit de reparación para JAI-1138/ JAI-1138L

**JAI-1138L** 745.00€

**Máquina con llave de impacto de 1"**

Máquina de eje largo con mecanismo de 2 percutores.

Características:

- Rotaciones en vacío: 5 000rpm
- Par trabajo: 2 430Nm
- Par máximo: 2 712Nm
- Longitud: 487mm
- Peso: 8 300g
- Tubo interior: 19mmø
- Consumo del aire: 255l/min
- Ruido: 100dB



**JAI-1408** 1 150.00€

**Máquina con llave de impacto pesados de 1"**

Máquina de eje corto.

Características:

- Rotaciones en vacío: 4 800rpm
- Par trabajo: 3 270Nm
- Par máximo: 3 520Nm
- Longitud: 370mm
- Peso: 10 500g
- Consumo del aire: 450l/min
- Presión operacional: 6,3bar
- Ruido: 105,5dB



**JAI-1408-RK** 73.50€

Kit de reparación para JAI-1408/ JAI-1408L

**JAI-1408L** 1 195.00€

**Máquina con llave de impacto pesados de 1"**

Máquina de veio longo.

Características:

Rotaciones en vacío:	4 800rpm
Par trabajo:	3 270Nm
Par máximo:	3 520Nm
Longitud:	570mm
Peso:	11 900g
Consumo del aire:	450l/min
Presión operacional:	6,3bar
Ruido:	105,5dB

**JAR-1012** 77.00€

**Trinquete neumático de 1/4"**

Características:

Rotaciones en vacío:	230rpm
Par máximo:	40Nm
Longitud:	140mm
Peso:	469g
Tubo interior:	10mmø
Consumo del aire:	338l/min

**JAR-1012-RK** 29.50€

**Kit de reparación para JAR-1012**
**JAR-1013** 79.00€

**Trinquete neumático de 3/8"**

Características:

Rotaciones en vacío:	230rpm
Par máximo:	40Nm
Longitud:	140mm
Peso:	469g
Tubo interior:	10mmø
Consumo del aire:	338l/min

**JAR-1013-RK** 30.00€

**Kit de reparación para JAR-1013**
**JAR-1094** 100.00€

**Trinquete neumático de 1/2"**

Características:

Rotaciones en vacío:	170rpm
Par máximo:	100Nm
Longitud:	275mm
Peso:	1 400g
Tubo interior:	10mmø
Consumo del aire:	113l/min
Ruido:	87dB

**JAR-1094-RK** 33.00€

**Kit de reparación para JAR-1094**
**JAR-6309AK** 127.00€

**Trinquete neumático de 1/2" con kit de llaves**

Características:

Rotaciones en vacío:	170rpm
Par máximo:	100Nm
Longitud:	275mm
Peso:	1 400g
Tubo interior:	10mmø



Accesorios:

 Chaves: 9; 10; 11; 13; 14; 17 e 19mm  
 Extensão: 75mm  
 União universal de 1/2"  
 Bits y porta bits  
 Mala

**JAR-6309A-RK** 24.50€

**Kit de reparación para JAR-6309A**
**JAR-6310A** 89.00€

**Trinquete neumático de 3/8"**

Características:

Rotaciones en vacío:	170rpm
Par máximo:	100Nm
Longitud:	275mm
Peso:	1 300g
Tubo interior:	10mmø

**JAR-6310A-RK** 24.50€

**Kit de reparación para JAR-6310A**
**JAR-6310AK** 139.00€

**Trinquete neumático de 3/8" con kit de llaves**

Características:

Rotaciones en vacío:	170rpm
Par máximo:	100Nm
Longitud:	275mm
Peso:	1 300g
Tubo interior:	10mmø



Accesorios:

 Llaves: 9; 10; 11; 13; 14; 17 y 19mm  
 Extensão: 75mm  
 União universal de 3/8"  
 Puntas y porta puntas  
 Maleta

**JAR-1033** 275.00€

Trinquete neumático combinado de 3/4" con kit de llaves

Características:

- Rotaciones en vacío: 180rpm
- Par máximo: 107Nm
- Longitud: 9,5mm
- Peso: 1 400g
- Tubo interior: 10mmø



Accesorios:



Llaves: 8 a 19mm  
Adaptadores

**JAR-1033-RK** 67.00€

Kit de reparación para JAR-1033A

**JAD-0413** 105.00€

Taladradora reversible neumática de 3/8"

Características:

- Rotaciones en vacío: 1 800rpm
- Motor: 0,4cv
- Capacidad del mandril: 10mm
- Longitud: 210mm
- Peso: 950g
- Tubo interior: 10mmø
- Consumo del aire: 99l/min
- Vibración: 3,3M7S<sup>2</sup>
- Ruido: 80dB



**JAD-0413-RK** 10.10€

Kit de reparación para JAD-0413

**JAD-1020** 94.00€

Taladradora reversible neumática de 1/2"

Características:

- Rotaciones en vacío: 800rpm
- Capacidad del mandril: 13mm (apert con llave)
- Longitud: 220mm
- Peso: 1 300g
- Tubo interior: 10mmø



**JAD-1020-RK** 2.30€

Kit de reparación para JAD-1020



**JAD-1021** 104.00€

Taladradora neumática angular de 3/8"

Características:

- Rotaciones en vacío: 1 900rpm
- Capacidad del mandril: 10mm (apert con llave)
- Longitud/ altura: 190x110mm
- Peso: 960g
- Tubo interior: 10mmø
- Consumo del aire: 280l/min



**JAD-1021-RK** 12.50€

Kit de reparación para JAD-1021

**JAD-1027** 114.00€

Taladradora reversible neumática de 1/2"

Características:

- Rotaciones en vacío: 800rpm
- Capacidad del mandril: 13mm (apert sin llave)
- Longitud: 178mm
- Peso: 1 820g
- Tubo interior: 10mmø



**JAD-1027-RK** 2.00€

Kit de reparación para JAD-1027

**JAD-6252A** 59.00€

Taladradora neumática de 3/8"

Características:

- Rotaciones en vacío: 2 500rpm
- Capacidad del mandril: 9,5mm (apert con llave)
- Longitud: 228mm
- Peso: 900g
- Tubo interior: 10mmø



**JAD-6252A-RK** 3.60€

Kit de reparación para JAD-6252

**JAB-1017** 88.00€

Atornilladora neumática reversible de 1/4"

Características:

- Rotaciones en vacío: 1 800rpm
- Capacidad del mandril: 1/4"
- Longitud: 190mm
- Peso: 1 100g
- Tubo interior: 10mmø



**JAB-1017-RK** 1.90€

Kit de reparación para JAB-1017



**JAB-1018**

102.00€

Atornilladora neumática reversible de 1/4"

Características:

Rotaciones en vacío: 800rpm  
 Capacidad del mandril: 1/4"  
 Longitud: 226mm  
 Peso: 1 300g  
 Tubo interior: 10mmø



**JAB-1018-RK**

1.65€

Kit de reparación para JAB-1018

**JAB-7003A**

112.00€

Atornilladora neumática reversible de 1/4"

Características:

Rotaciones en vacío: 1 800rpm  
 Capacidad del mandril: 1/4"  
 Longitud: 254mm  
 Peso: 1 140g  
 Tubo interior: 10mmø



**JAB-7003A-RK**

4.20€

Kit de reparación para JAB-7003A

**JAD-1015K**

310.00€

Fresadora de puntos de soldadura con kit de accesorios

Características:

Rotaciones en vacío: 1 800rpm  
 Capacidad perforación: 8mm  
 Longitud: 254mm  
 Peso: 2 100g  
 Tubo interior: 10mmø



Accesorios:



Llave 6 caras: 2,5mm  
 Fresas  
 Lubrificador  
 Racor: 1/4"x1/4"  
 Maleta

**JAD-1015-RK**

2.40€

Kit de reparación para JAD-1015K

**JAZ-7207**

69.00€

Juego de 5 fresas para fresadora de puntos

Aplicable a los modelos: JAD-1015/ JAD-6246

Características:

Fresas en HSS y cobalto  
 Diámetro: 6,5mmø



**JAG-0903-MS**

12.50€

Juego de buriles

Aplicable a los modelos:

JAG-0903/ JAG-0906/ JAG-0913/ JAG-0923/ JAG-0925/ JAG-0955



**JAG-0906RMK**

75.00€

Esmeriladora recta neumática de 1/4" con kit de accesorios

Características:

Rotaciones en vacío: 22 000rpm  
 Capacidad de la pinza: 6mm  
 Potencia: 0,4Kw  
 Longitud: 175mm  
 Peso: 490g  
 Tubo interior: 10mmø



Accesorios:

Buriles: 6mm (1/4")  
 Buriles: 3mm (1/8")  
 Llaves  
 Reducción: 3mm (1/8")  
 Maleta



**JAG-0906RMK-RK**

6.90€

Kit de reparación para JAG-0906RMK

**JAG-0913RMK**

93.00€

Esmeriladora neumática angular de 1/4" con kit de accesorios

Características:

Rotaciones en vacío: 18 000rpm  
 Capacidad de la pinza: 6mm  
 Potencia: 0,21Kw  
 Longitud: 155mm  
 Peso: 490g  
 Tubo interior: 10mmø



Accesorios:

Buriles: 6mm (1/4")  
 Buriles: 3mm (1/8")  
 Llaves  
 Reducción: 3mm (1/8")  
 Maleta



**JAG-0913RMK-RK**

5.20€

Kit de reparación para JAG-0913RMK



**JAG-0923RM**

47.00€

Mini esmeriladora recta neumática de 1/4"

Características:

Rotaciones en vacío:	25 000rpm
Capacidad de la pinza:	6mm
Potencia:	0,5hp
Longitud:	170mm
Peso:	700g
Consumo del aire:	76l/min
Presión operacional:	6,2bar
Ruido:	97dB



**JAG-0923RM-RK**

5.40€

Kit de reparación para JAG-0923RM

**JAG-0925RM**

48.00€

Esmeriladora recta neumática de 1/4"

Características:

Rotaciones en vacío:	22 000rpm
Capacidad de la pinza:	6mm
Potencia:	0,5hp
Longitud:	170mm
Peso:	700g
Consumo del aire:	113l/min
Presión operacional:	6,2bar
Ruido:	97dB



**JAG-0925RM-RK**

16.50€

Kit de reparación para JAG-0925RM

**JAG-0955RM**

80.00€

Esmeriladora recta neumática de 1/4"

Características:

Rotaciones en vacío:	22 000rpm
Capacidad de la pinza:	6mm
Potencia:	0,5hp
Longitud:	260mm
Peso:	700g
Consumo del aire:	113l/min
Presión operacional:	6,2bar
Ruido:	97dB



**JAG-0955RM-RK**

6.30€

Kit de reparación para JAG-0955RM

**JAG-6638**

135.00€

Amoladora neumática angular de 125mm

Características:

Rotaciones en vacío:	11 000rpm
Dimensión del disco:	125mm
Potencia:	0,7Kw
Longitud:	230mm
Peso:	1 800g
Dimensión del disco:	10mmø
Vibración mango:	6,45m/s <sup>2</sup>
Ruido:	86dB



**JAG-6638-RK**

64.00€

Kit de reparación para JAG-6638

**JAG-6639**

280.00€

Amoladora neumática angular de 180mm

Características:

Rotaciones en vacío:	7 000rpm
Dimensión del disco:	180mm (7")
Potencia:	1,4Kw
Longitud:	343mm
Peso:	3 100g
Tubo interior:	10mmø



**JAG-6639-RK**

82.00€

Kit de reparación para JAG-6639

**JAS-6505**

120.00€

Pulidora de ángulo de 180mm

Características:

Rotaciones en vacío:	4 500rpm
Dimensión del disco:	178mm
Rosca del eje:	5,8" (11UNC)
Longitud:	406mm
Peso:	2 500g
Tubo interior:	10mmø



**JAS-6505-RK**

5.10€

Kit de reparación para JAS-6505

**JAS-6551**

131.00€

Pulidora de ángulo de 180mm

Características:

Rotaciones en vacío:	2 500rpm
Dimensión del disco:	178mm
Rosca del eje:	5,8" (11UNC)
Longitud:	406mm
Peso:	2 500g
Tubo interior:	10mmø



**JAS-6551-RK**

5.15€

Kit de reparación para JAS-6551



**JAS-6552** 125.00€

Pulidor neumático de 180mm

Características:

Rotaciones en vacío: 2 500rpm  
 Dimensión del disco: 178mm  
 Peso: 2 800g  
 Tubo interior: 10mmø  
 Consumo del aire: 260l/min



**JAS-6552-RK** 16.00€

Kit de reparación para JAS-6552

**JAS-0010** 212.00€

Lijadora con patín triangular y base en vinilo

Características:

Rotaciones en vacío: 9 000rpm  
 Dimensión de la base: 93x132mm  
 Tubo interior: 10mmø  
 Consumo del aire: 260l/min



**JAS-0010-RK** 20.00€

Kit de reparación para JAS-0010

**JAS-0010-41** 19.40€

Base para lijadora JAS-0010

Dimensión de la base: 93x132mm



**JAS-0413** 115.00€

Lijadora orbital angular

Maquina compuesta

Características:

Rotaciones en vacío: 15 000rpm  
 Dimensión del disco: 76mm  
 Motor: 0,4cv  
 Longitud: 125mm  
 Peso: 720g  
 Tubo interior: 10mmø  
 Consumo del aire: 99l/min  
 Vibración: 6,3m/s<sup>2</sup>  
 Ruido: 80dB



**JAS-0413-RK** 9.50€

Kit de reparación para JAS-0413

**JAS-0423K** 147.00€

Pulidora orbital angular

Maquina compuesta

Características:

Rotaciones en vacío: 2 100rpm  
 Dimensión del disco: 76mm  
 Motor: 0,4cv  
 Longitud: 135mm  
 Peso: 770g  
 Consumo del aire: 99l/min  
 Presión operacional: 6,2bar  
 Vibración: 2,3m/s<sup>2</sup>  
 Ruido: 78dB



**JAS-0423-RK** 20.00€

Kit de reparación para JAS-0423

**JAS-1021-6HE(2.5)** 185.00€

Lijadora orbital angular con base en vinilo adhesivo con 6"

Maquina compuesta

Características:

Rotaciones en vacío: 12 000rpm  
 Dimensión del disco: 150mm  
 Diámetro: 2,5mm  
 Peso: 960g  
 Tubo interior: 10mmø  
 Consumo del aire: 170l/min



**JAS-1021-6HE-RK** 9.20€

Kit de reparación para JAS-1021-6HE

**JAS-1206-6HE** 294.00€

Lijadora orbital para conexión con central de aspiración con base en vinilo adhesivo con 6"

Maquina compuesta

Características:

Rotaciones en vacío: 12 000rpm  
 Dimensión del disco: 150mm  
 Diámetro: 5mm  
 Tubo interior: 10mmø



**JAS-1206-6HE-RK** 43.00€

Kit de reparación para JAS-1206-6HE

**JAS-1206-6HP** 47.00€

Base en velcro para lijadora JAS-1206/ JAS-1207 con 6"



**JAS-1207-6HE** 370.00€

Lijadora orbital con auto-aspiración con base en vinilo adhesivo con 6"

Máquina compuesta

Características:

Rotaciones en vacío: 12 000rpm

Dimensión del disco: 150mm

Diámetro: 5mm

Tubo interior: 10mmø

Bolsa de recolección de polvo



**JAS-1207-6HE-RK** 43.00€

Kit de reparación para JAS-1207-6HE

**JAS-1206-6HP** 47.00€

Base con velcro para lijadora JAS-1206/ JAS-1207 con 6"

**JAS-1031-6HE** 199.00€

Lijadora orbital con base en velcro con 6"

Máquina compuesta

Características:

Rotaciones en vacío: 10 000rpm

Dimensión del disco: 150mm

Diámetro: 5mm

Peso: 1 040g

Tubo interior: 10mmø



**JAS-1031-6HE-RK** 66.00€

Kit de reparación para JAS-1031-6HE

**JAS-1031-6VE-RK** 54.00€

Kit de reparación para JAS-1031-6VE

**JAS-1031-6HP** 19.00€

Base en velcro para lijadora JAS-1031/ JAS 6535-6HE

**JAS-1231-HE** 360.00€

Lijadora rectangular con base en vinilo adhesivo para conexión con central de aspiración

Máquina compuesta

Características:

Dimensión de la base: 75x110mm

Peso: 750g

Tubo interior: 10mmø

Consumo del aire: 481l/min



**JAS-1231-HE-RK** 39.00€

Kit de reparación para JAS-1231-HE

**JAS-6531** 129.00€

Lijadora rectangular estrecha

Máquina compuesta

Características:

Movimientos/ minuto: 2 500

Dimensión de la base: 63,5x407mm

Longitud: 406mm

Peso: 3 100g

Tubo interior: 10mmø

Consumo del aire: 226l/min

Ruido: 93,3dB



**JAS-6531-RK** 2.40€

Kit de reparación para JAS-6531

**JAS-6535-5HE** 182.00€

Lijadora orbital con base en velcro con 5"

Máquina compuesta

Características:

Rotaciones en vacío: 10 000rpm

Dimensión del disco: 125mm

Diámetro: 5mm

Peso: 1 040g

Tubo interior: 10mmø



**JAS-6535-5HE-RK** 41.00€

Kit de reparación para JAS-6535-5HE

**JAS-6535-5VE-RK** 35.50€

Kit de reparación para JAS-6535-5VE

**JAS-6535-6HE** 167.00€

Lijadora orbital con base en velcro con 6"

Máquina compuesta

Características:

Rotaciones en vacío: 10 000rpm

Dimensión del disco: 150mm

Diámetro: 5mm

Peso: 1 040g

Tubo interior: 10mmø



**JAS-6535-6HE-RK** 45.00€

Kit de reparación para JAS-6535-6HE

**JAS-1031-6HP** 19.00€

Base en velcro para lijadora JAS-1031/ JAS 6535-6HE



**JA-6111**

94.00€

**Pistola de pintura tipo gravedad**

Características:

Entrada de aire:	1/4"
Capacidad del vaso:	600 ml
Boquilla estándar:	1,4mm
Tubo interior:	10mmø

**JA-6111**
**Kit boquilla para pistola JA-6111**

Ref.	Medida (mm)	Precio
JA-6111-NS	1.3	36.50€
JA-6111-NS17	1.7	37.00€
JA-6111-NS20	2	38.00€

**JA-6111K**

205.00€

**Juego de pistola de pintura tipo gravedad y accesorios**

Características:

Pistola:	JA-6111
Capacidad vaso nylon:	250 y 600 ml
Boquilla:	1,7 y 2mm
Tubo interior:	10mmø
Kit de limpieza	
Maleta	

**JA-HVLP-1080GK**

275.00€

**Juego de pistola de pintura HVLP y accesorios**

Características:

Pistola:	JA-HVLP-1 080G
Capacidad vaso nylon:	250 y 600ml
Boquilla:	1,4; 1,7 y 2mm
Tubo interior:	10mmø
Kit de limpieza	
Maleta	

**JA-HVLP-1080GD-N1.4**

48.00€

**Boquilla de 1.4 para pistola JA-HVLP-1 080g**

**JA-HVLP-300C (1.3)**

158.00€

**Pistola de pintura tipo gravedad**

Características:

Entrada de aire:	1/4"
Capacidad vaso nylon:	600 ml
Boquilla estándar:	1,3mm
Presión del aire:	2bar
Consumo del aire:	481l/min
Peso:	545g
Tubo interior:	10mmø

**JA-HVLP-3000-NS17**

61.00€

**Kit boquilla 1.7 para pistola de pintura**
**JA-HVLP-3000-NS19**

61.00€

**Kit boquilla 1.9 para pistola de pintura**
**JA-300C-NS13**

60.00€

**Boquilla completa 1.3 para pistola de pintura JA-HVLP3000/ JA-HVLP300C**
**JA-LVLP-0303W**

162.00€

**Pistola de pintura para tintas a base de agua tipo gravedad**

Características:

Entrada de aire:	1/4"
Capacidad vaso nylon:	600 ml
Boquilla estándar:	1,3mm
Tubo interior:	10mmø

**JA-LVLP-0303W-N**

47.50€

**Kit boquilla 1.3 para pistola de pintura**
**JA-LVLP-0303W-N18**

48.50€

**Kit boquilla 1.8 para pistola de pintura**

**JA-HVLP-6112**

143.00€

**Pistola de pintura tipo gravedad**

Características:

Entrada de aire:	1/4"
Capacidad vaso nylon:	125 ml
Boquilla estándar:	1mm
Presión del aire:	3bar
Consumo del aire:	112l/min
Peso:	240g
Tubo interior:	10mmø



**ACC-609** 20.00€

Regulador de aire 0-10 bar



**JA-3806C** 9.50€

Regulador de presión para pistola de pintura  
Aplicable a la pistola JA-HVLP-6112



**JA-3808A** 9.70€

Separador agua/sustancias aceitosas para pistolas de pintura



**JA-0001RK** 4.30€

Kit de reparación para pistola de pintura



**AS-0026** 9.80€

Kit de limpieza para pistolas de pintura con 12 piezas



**AS-0013A2** 25.00€

Vaso de aluminio para pistola de pintura tipo gravedad

Capacidad: 600ml



**AS-001**

Vaso para pistola de pintura

Ref.	Capacidad (ml)	Precio
AS-0013	600	11.50€
AS-0015	250	8.30€



**JA-300C-28**

11.00€

Vaso para pistola de pintura JA-HVLP-3000

Capacidad: 600ml  
Funda no incluida



**AS-001**

Caperuza para vaso de pistola de pintura

Ref.	Capacidad (ml)	Precio
AS-0013C	600	2.50€
AS-0015C	250	1.15€



**JA-950**

58.00€

Pistola de secado para tintas a base de agua



**JA-950-04**

3.00€

Filtro de malla para pistola JA-950

**JA-960**

180.00€

Soporte para 2 pistolas de secado

No se incluyen las pistolas



**JAS-0452**

185.00€

Lijadora de banda ancha

Máquina compuesta

Características:

Rotaciones en vacío:	16 000rpm
Dimensión de la base:	20x520mm
Longitud:	430mm
Peso:	1 400g
Tubo interior:	10mmø
Consumo del aire:	113l/min
Vibración:	2,8m/s <sup>2</sup>
Ruido:	95dB



**JAS-0452-RK** 28.50€

Kit de reparación para JAS-0452

**JAS-6542** 182.00€

**Lijadora de banda ancha**

Características:

 Rotaciones en vacío: 16 000rpm  
 Dimensión de la base: 20x520mm  
 Longitud: 360mm  
 Peso: 1 200g  
 Tubo interior: 10mmø

**JAS-6542-RK** 16.00€

Kit de reparación para JAS-6542

**JAS-6543** 102.00€

**Lijadora de banda estrecha**

Características:

 Rotaciones en vacío: 16 000rpm  
 Dimensión de la base: 10x330mm  
 Longitud: 290mm  
 Peso: 800g  
 Longitud: 10mmø

**JAS-6543-RK** 19.50€

Kit de reparación para JAS-6543

**JAT-1020K** 229.00€

**Sierra/ lima neumática baja vibración con kit accesorios**

Mecanismo de baixa vibraçao

Características:

 Oscilación por minuto: 16 000bpm  
 Curso: 25mm  
 Peso: 960g  
 Tubo interior: 10mmø

Accesorios:

 Cuchillas: T14; T18 y T24  
 Limas  
 Maleta

**JAT-1020-RK** 51.00€

Kit de reparación para JAT-1020

**JAT-12F**
**Limas para JAT-1020**

Ref.	Forma	Precio
JAT-12F1	triangular	5.80€
JAT-12F2	media caña	6.20€
JAT-12F3	redonda	5.80€
JAT-12F4	plana	5.80€

**JAT-20T**
**Sierras para JAT-1020**

Ref.	Dientes	Precio
JAT-20T14	14	4.10€
JAT-20T18	18	4.10€
JAT-20T24	24	4.10€

**JAT-1041** 163.00€

**Pulidor neumático de válvulas**

Características:

 Oscilación por minuto: 3 000bpm  
 Capacidad máxima: 4,5mmø  
 Longitud: 153,5mm  
 Peso: 1 550g  
 Tubo interior: 10mmø  
 Consumo del aire: 100l/min  
 Ventosas: 16; 20; 30 y 35mm

**JAT-1041-16S** 15.50€

**Juego de 4 ventosas para JAT-1041**

Características:

Medidas: 16; 20; 30 y 35mm

**JAT-1011** 130.00€

**Sierra neumática de baja vibración**

Características:

 Oscilación por minuto: 11 000bpm  
 Curso: 8mm  
 Peso: 450g  
 Tubo interior: 10mmø  
 Consumo del aire: 90l/min  
 Ruido: 86,8dB

**JAT-1011-RK** 25.00€

Kit de reparación para JAT-1011

**JAT-6613** 185.00€

Máquina neumática de decapar

Características:

- Diámetro de la base: 105mm
- Rotaciones en vacío: 3.500 rpm
- Entrada de aire: 1/4"
- Dimensiones (long/alt): 203x106mm
- Peso: 960g
- Consumo de aire: 280l/min
- Ruido: 98dB



**JAT-6676** 106.00€

Sierra neumática

Características:

- Capacidad del corte: 1,6mm (espesor acero)
- Oscilación por minuto: 10 000bpm
- Curso: 10mm
- Longitud: 235mm
- Peso: 960g
- Tubo interior: 10mmø



**JAT-6676-RK** 6.50€

Kit de reparación para JAT-6676

**JAT-10T**

Sierras para JAT-6676 5 unidades

Ref.	Dientes	Longitud (mm)	Precio
JAT-10T18	18	75	12.30€
JAT-10T32	32	75	12.50€



**JAT-6421** 42.50€

Máquina de corte neumático de discos con 3"

Características:

- Rotaciones en vacío: 20 000rpm
- Peso: 1 040g
- Tubo interior: 10mmø



**JAT-6421-RK** 2.20€

Kit de reparación para JAT-6421

**JAT-6421-33** 1.40€

Disco de sierra para JAT-6421



**JAT-6441K** 127.00€

Cuchilla neumático con kit de accesorios

Características:

- Oscilación por minuto: 22 000bpm
- Longitud: 120mm
- Peso: 1 200g
- Tubo interior: 10mmø

Accesorios:

- Cuchillas: 30; 35 y 57mm
- Maleta

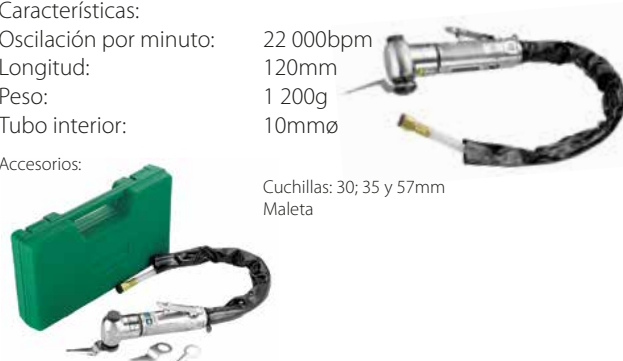

**JAT-6441-RK** 1.50€

Kit de reparación para JAT-6441

**CF-K**

Cuchillas para JAT-6441K

Ref.	Longitud (mm)	Precio
CF-K-C	35	9.00€
CF-K-E	57	7.00€
CF-K-F	90	19.30€
CF-K-G	24	12.00€
CF-K-I	36	14.10€
CF-K-J	63	17.00€

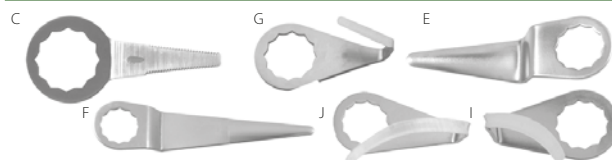

**JAT-6952** 82.00€

Tijera neumática recta

Características:

- Oscilación por minuto: 2 300/ 2 500bpm
- Capacidad del corte: 1,2mm (espesor acero)
- Tamaño do corte: 5,5mm
- Longitud: 255mm
- Peso: 1 000g
- Tubo interior: 10mmø

Accesorios:

- Cuchillas: 30; 35 y 57mm



**JAT-6952-RK** 1.50€

Kit de reparación para JAT-6952



**JAT-6952P**
**87.00€**
**Tijera neumática**
**Características:**

Oscilación por minuto:	2 200bpm
Capacidad del corte:	1,2mm (espesor acero)
Tamaño do corte:	5,5mm
Longitud:	215mm
Peso:	1 200g
Tubo interior:	10mmø

**JAT-6952P-RK**
**1.50€**
**Kit de reparación para JAT-6952P**
**JAT-6952P**
**Cuchillas para JAT-6952/P**

Ref.	Cuchillas	Precio
JAT-6952P-37	izquierda	9.00€
JAT-6952P-39	central	10.80€
JAT-6952P-40	derecha	9.00€

**JAT-6943A**
**104.00€**
**Alicate neumático de rebajos**
**Características:**

Capacidad del corte:	1,4mm
Capacidad de rebajo:	8mm
Dobla:	12mm
Longitud:	248mm
Peso:	1 300g
Tubo interior:	10mmø

**JAT-6943A-RK**
**7.50€**
**Kit de reparación para JAT-6943A**
**JAT-6412**
**63.00€**
**Roedora neumática**
**Características:**

Velocidad de corte:	3 200rpm
Capacidad del corte:	1,4mm (espesor acero)
Longitud:	210mm
Peso:	1 000g
Tubo interior:	10mmø

**JAT-6412-RK**
**1.50€**
**Kit de reparación para JAT-6412**
**JAH-0288**
**104.00€**
**Martillo neumático de agujas**
**Características:**

Golpes por minuto:	5 000
Número de agujas:	12
Longitud:	290mm
Peso:	1 200g
Consumo del aire:	90l/min
Tubo interior:	10mmø

**JAH-0288-15**
**12.50€**
**Cinzel para JAH-0288**
**JAH-0288-16**
**6.70€**
**Juego de agujas para JAH-0288**
**JAH-0288-17**
**5.50€**
**Alojamiento de agujas para JAH-0288**
**JAH-0288-RK**
**23.50€**
**Kit de reparación para JAH-0288**
**JAH-6837**
**140.00€**
**Martillo tallador recto**
**Características:**

Golpes por minuto:	4 600
Encajadura:	25,4x43,5
Longitud:	380mm
Peso:	2 100g
Tubo interior:	10mmø

**JAH-6837-RK**
**16.50€**
**Kit de reparación para JAH-6837**
**JAH-6837-5**
**Cinzel para JAH-6837**

Ref.	Tipo	Longitud. (mm)	Precio
JAH-6837-50	plan	35-175	17.00€
JAH-6837-50-2	puntero		16.50€

**JAH-7104H**
**320.00€**
**Martillo neumático de 1"**
**Características:**

Golpes por minuto:	2 820
Longitud:	308mm
Peso:	5 500g
Consumo del aire:	228l/min
Tubo interior:	10mmø

**JAH-7104H-RK**
**5.00€**
**Kit de reparación para JAH-7104H**

**JAZ-01**

**Buril hexagonal**

Ref.	Tipo	Precio
JAZ-011H	boquilla	19.50€
JAZ-016H	punta	19.50€

**JAT-6034**

92.00€

**Remachadora neumática**

Características:

Capacidad:	2,4 a 4,8mm (acero+acero inoxidable)
Potencia:	10 250Nm
Carrera de tracción:	16mm
Longitud:	308mm
Peso:	1 500g
Tubo interior:	10mmø



**JAT-6034-RK**

21.60€

**Kit de reparación para JAT-6034**

**JAT-6673**

230.00€

**Remachadora neumática**

Características:

Capacidad:	2,4 a 6,4mm (acero+aço inox.)
Carrera de tracción:	18mm
Peso:	1 750g
Consumo del aire:	2,9l/ciclo
Tubo interior:	10mmø



**JAT-6673-RK**

48.00€

**Kit de reparación para JAT-6673**

**JAT-1035**

368.00€

**Remachadora neumática de remaches hembra**

Características:

Dimensiones:	270x190mm
Capacidad:	M4-M10 (acero)
Capacidad:	M4-M8 (acero inox.)
Carrera de tracción:	6mm
Peso:	1 550g
Consumo del aire:	1,5l/ciclo
Tubo interior:	10mmø



**JAT-1035-RK**

6.70€

**Kit de reparación para JAT-1035**

**JAT-460**

21.00€

**Bomba de engrase palanca**

Actuación por palanca

Capacidad: 400cc



**JAT-480**

27.00€

**Bomba de engrase palanca**

Actuación por pistola

Capacidad: 400cc



**JAT-480\_NS**

7.50€

**Boquilla flexible para JAT-480**

**JAT-6004K**

51.00€

**Bomba neumática de boquilla dura de engrase con accesorios**

Palanca de accionamiento manual

Capacidad: 400cc

Accesorios:



Boquilla flexible  
Alavanca por accionamento manual

**JAT-501**

50.00€

**Pistola neumática para masilla**

Características:

Entrada:	1/4"
Capacidad:	310ml
Presión:	2,5 a 5,1bar
Tubo interior:	10mmø
Cartucho en forma de cono	



**JA-5032**

33.50€

**Pistola neumática para masilla**

Características:

Presión:	2 a 4bar
Longitud:	330mm
Peso:	1 225g
Consumo del aire:	170l/min
Tubo interior:	10mmø
Material:	metal



**JAT-6904S**

17.00€

Pistola para agua con kit de accesorios con 5 boquillas

**JAT-6905B**

14.30€

Pistola para aire

**JAT-6905C**

3.00€

 Boquilla para pistola de aire  
Boquilla triangular extendida

**JAT-6905J**

10.00€

 Boquilla para pistolette de aire  
Boquilla con cepillo en nylon

**JAT-6959**

5.20€

Pistola de aire con boquilla larga

 Longitud: 100mm  
Presión de trabajo: 75-120psi  
Ruido: 85-90dba  
Hembra: 1/4"

**JAT-6959A**

6.50€

Pistola de aire con boquilla larga de 1/4"

 Longitud: 280mm  
Presión de trabajo: 75-120psi  
Ruido: 85-90dba  
Hembra: 1/4"

**JAZ-0002**

Enrollador aire

Ref.	Manguera (mm)	Manguera (m)	Precio
JAZ-0002A	8x12	9	92.00€
JAZ-0002B	9,5x13,3	7,5	92.00€
JAZ-0002C	6,5x10	10	89.00€

**Accesorios para redes de aire comprimido**
**JAZ-39520**

173.00€

Enrollador móvil para aire de 3/8"

 Longitud: 20m  
Presión máxima: 15bar  
Peso: 7 000g  
Interior manguera: 9,5mmø  
Enlace: 3/8"

**JAZ-725**

Mini lubricante aceite para máquinas neumáticas

Ref.	Medida	Precio
JAZ-7253	1/4"	6.20€
JAZ-7254	3/8"	9.20€

**JAZ-051**

Filtro lubricante con regulador de presión

Ref.	Entrada	Flujo (l/min)	Precio
JAZ-0512	1/4"	1 000	66.00€
JAZ-0513	3/8"	1 350	67.00€
JAZ-0514	1/2"	3 000	98.00€
JAZ-0516	3/4"	3 100	107.00€



Nota: La presión máxima de alimentación es de 8.5bar

**JAZ-0513**

Copa plástico para filtros lubricante JAZ-0512/ JAZ-0513

Ref.	Especif.	Precio
JAZ-0513-09	ar	4.50€
JAZ-0513-50	aceite	4.60€

**JAZ-0514**

Copa plástico para filtros lubricante JAZ-0514/ JAZ-0515

Ref.	Especif.	Precio
JAZ-0514-09	ar	6.20€
JAZ-0514-48	aceite	6.20€

**JAZ-6704A**

96.00€

Filtro lubricante con regulador de presión 1/2"

Flujo: 1 250l/min



**JAZ-6710A**

Filtro de aire 1/2"

37.50€



**JAZ-6711A**

Regulador de presión 1/2"

46.50€



**JAZ-6712A**

Lubricador del aire 1/2"

37.50€



**JAZ-6704**

Copa plástico para filtros lubricadores JAZ-6704A/ JAZ-6710A

Ref.	Especif.	Precio
JAZ-6704-W	ar	9.30€
JAZ-6704-O	aceite	4.90€

**JAZ-7214**

Extensor en espiral hembra de 1/4"

Ref.	Medida (mm)	Longitud (m)	Precio
JAZ-7214F	5x8	13	19.00€
JAZ-7214S	6,5x10	13	27.50€
JAZ-7214Z	8x12	15	41.00€



**GM-0**

Racor hembra

Ref.	Medida	Precio
GM-02AF	1/4"	5.60€
GM-03AF	3/8"	5.90€
GM-04AF	1/2"	6.50€



**GM-0**

Racor macho

Ref.	Medida	Precio
GM-02AM	1/4"	6.20€
GM-03AM	3/8"	6.00€
GM-04AM	1/2"	6.10€



**GM-0**

Racor tubo

Ref.	Medida	Precio
GM-02AH	1/4"	6.30€
GM-03AH	3/8"	6.70€
GM-04AH	1/2"	6.80€
GM-02BH	5/16"	6.70€



**GM-0**

Punta hembra

Ref.	Medida	Precio
GM-02PF	1/4"	1.10€
GM-03PF	3/8"	2.00€
GM-04PF	1/2"	2.30€



**GM-0**

Punta macho

Ref.	Medida	Precio
GM-02PM	1/4"	1.00€
GM-03PM	3/8"	2.00€
GM-04PM	1/2"	2.30€



**GM-0**

Punta tubo

Ref.	Medida	Precio
GM-02PH	1/4"	1.20€
GM-03PH	3/8"	1.20€
GM-04PH	1/2"	1.50€
GM-02BPH	5/16"	1.20€



**KIT AR**

48.50€

Juego de accesorios de unión a red de aire

Composición:

- GM-02AF Racor hembra de 1/4"
- GM-02PF Punta hembra de 1/4"
- GM-02PM Punta macho de 1/4"
- JAT-6905B Pistola simple para aire
- JAZ-7214S Extensor en espiral 13m





**JONNESWAY**®

**Comercialización**



**Comercialización**

**C-DS4** 399.00€

Expositor de herramientas con paneles perforados y 30 ganchos

Medidas:  
 Altura: 2 140mm  
 Profundidad: 660mm  
 Ancho: 940mm



**C-DS4-H** 1.10€

Gancho para expositor C-DS4

**C-DS1D** 110.00€

Armario expositor para llaves vaso/ impacto

Medidas:  
 Altura: 430mm  
 Profundidad: 110mm  
 Ancho: 580mm



**C-DS71** 99.00€

Expositor vacío en acrílico para 96 llaves série D71

Medidas:  
 Altura: 210mm  
 Profundidad: 250mm  
 Ancho: 595mm

**D71PP96-EXP** 375.00€

Expositor con 96 llaves série D71

Composición:

**D71P** Llaves phillips: PH1x38; PH1x80; PH2x100; PH2x38 y PH3x150

**D71S** Llaves ranuradas: 2,4x50; 4x80; 5,5x125; 5,5x200; 6,5x100; 6,5x150; 6,5x38; 8x150 y 9,5x175

**D71T** Llaves torx: T10; T15; T20; T25 y T30

**D71Z** Llaves pozi: PZ1; PZ2 y PZ3



**FITA JW** 3.00€

Cinta de embalaje Jonnesway



**BOUTJW01A** 7.00€

Camiseta negra

Con logotipo de Jonnesway impreso en el pecho y la manga.



**BOUTJW02A** 4.50€

Gorra tipo béisbol negra

Con logotipo de Jonnesway bordado.



**BOUTJW03A** 27.50€

Bolígrafo 50 unidades

Con logotipo de Jonnesway impreso.



**BOUTJW15A** 34.00€

Bolígrafo touch 20 unidades

Con logotipo de Jonnesway impreso.



**BOUTJW04A** 32.00€

Polar beige

Con logotipo de Jonnesway bordado en el pecho.



**BOUTJW05A**

14.50€

Paraguas negro 1 unidad  
Con logotipo de Jonnesway impreso.



**BOUTJW06A**

55.00€

Lona Jonnesway  
Medidas: 1 480x890mm



**BOUTJW07A**

15.50€

Polo negro  
Con logotipo de Jonnesway bordado en el pecho.



**BOUTJW13A**

5.50€

Parasol  
Con logotipo de Jonnesway impreso.



**BOUTJW14A**

13.00€

Mochila



**BOUTJW08A**

43.00€

Mono mecánico verde  
Con logotipo de Jonnesway impreso en el pecho y en espalda.



**BOUTJW09A**

12.00€

Dispositivo de almacenamiento de datos - pen USB 1 unidad  
Capacidad: 4 Gb



**BOUTJW11A**

16.00€

Llaveros en acrílico (máquina) 10 unidades



**BOUTJW12A**

16.00€

Llaveros en acrílico (llave mixta) 10 unidades



**BOUTJW16A**

2.60€

Llavero 1 unidad







---

---

---

---

---

---

---

---

---

---

---

---

---

---

---

---

---

---

---

---

---

---

---

---

---

---

---

---

---

---

---

---

---

---

---

---

---

---

---

---

---

---

---

---

---

---

---

---

---

---

---

---

---

---

---

---

---

---

---

---





---

---

---

---

---

---

---

---

---

---

---

---

---

---

---

---

---

---

---

---

---

---

---

---

---

---

---

---

---

<b>AB0</b>	<b>Pag.</b>						
AB010001	140	AB030076-13	145	AE300064-05	112	AE310146B	114
AB010002	140	AB030076-14	145	AE300064-06	112	AE310146D	114
AB010002-A	140	AB030076-15	145	AE300064-07	112	AE310146E	114
AB010017	140	AB030076-17	145	AE300064-15	112	AE310150	115
AB010018	140	AB030076-18	145	AE300064-16	112	AE310172	115
AB010019	140	AB030076-20	145	AE300100-040	112	AE310180	115
AB010020	140	AB030076-21	145	AE300100-042	112	AE310183	115
AB010026S	140	AB030076-24	145	AE300100-060	112	AE320023	115
AB010041	140	AB030076-26	145	AE300103	112	AE320034	115
AB010042	140	AB030076-27	145	AE300149	25	AE320035	115
AB010043	140	AB030076-28	145	AE300152	112	AE320044	115
AB020002	140	AB030076-30	145	AE300154B	115	AE330004	142
AB020003	140	AB030076-32	145	AE300168	115	AE330005	142
AB020009	140	AB030076-34	145	AE300168-1	115	AE330008	142
AB020010	140	AB030089	141	AE300173	113	AE330009	143
AB020015	140	AB030100	142	AE300176-A	113	AE330013	143
AB020019	141	<b>AC</b>	<b>Pag.</b>	AE300201	116	AE330015	143
AB030014	141	ACC-609	158	AE300202	116	AE330016	143
AB030028	141	<b>AE0</b>	<b>Pag.</b>	AE300204	116	AE330030	143
AB030041	141	AE010015A	24	AE300205	116	AE330034	143
AB030043	141	AE010025A	24	AE300206	116	AE330035	143
AB030046	141	AE020009	22	AE300207	116	<b>AGO</b>	<b>Pag.</b>
AB030047	141	AE040020	112	AE300211	116	AG010002	83
AB030048	141	AE050003	24	AE300212	113	AG0100026SP	28
AB030056	112	AE060002	22	AE300215	116	AG010002SP	28
AB030060	141	AE060003	22	AE300220	116	AG010003	83
AB030061	112	AE070002A	22	AE310002	113	AG010005	83
AB030068A	141	AE080001	22	AE310003	142	AG010006	83
AB030068C	141	AE090025	23	AE310006	113	AG010008	83
AB030068D	141	AE090105A	23	AE310008	113	AG010009	83
AB030068F	141	<b>AE1</b>	<b>Pag.</b>	AE310010A	113	AG010011	83
AB030069A	141	AE110020	23	AE310013	113	AG010012	83
AB030069B	141	AE130003	23	AE310014	113	AG010023	142
AB030069C	141	AE130003-1	23	AE310016	113	AG010024	142
AB030069E	141	AE140013	24	AE310023	113	AG010024-1	142
AB030070B	141	AE150001	24	AE310034	114	AG010024-2	142
AB030070C	141	AE150002	24	AE310035	114	AG010030A	142
AB030070D	141	AE150005	112	AE310037	114	AG010034	116
AB030071	142	AE170002	24	AE310038	114	AG010035	116
AB030076-00	145	AE180001	24	AE310063	114	AG010036	117
AB030076-01	145	<b>AE2</b>	<b>Pag.</b>	AE310066	114	AG010046	117
AB030076-02	145	AE200003	25	AE310077	114	AG010049	117
AB030076-03	145	<b>AE3</b>	<b>Pag.</b>	AE310087	114	AG010055	142
AB030076-05	145	AE300025	25	AE310099	114	AG010055-B	142
AB030076-06	145	AE300064	112	AE310109	114	AG010059	117
AB030076-07	145	AE300064-02	112	AE310110	114	AG010059-10	117
AB030076-11	145	AE300064-03	112	AE310112	114	AG010059-12	117
		AE300064-04	112	AE310122	114	AG010059-6	117

AG010059-8	117	AI010086	119	AI020164	144	AI050152A	126
AG010099	117	AI010092	120	AI020178	122	AI050172	144
AG010109	117	AI010097	134	AI020180	122	AI050176	126
AG010111	117	AI010104	120	AI020184S	122	AI050191	126
AG010118A	117	AI010107	133	AI020185	122	AI050192	126
AG010138	143	AI010108	136	AI020186	134	AI060006	126
AG010138-B	143	AI010110	137	AI020205	122	AI060020	126
AG010140	143	AI010114	134	AI030002	124	AI060030	127
AG010141	143	AI010115	132	AI030007	122	AI060031	127
AG010142	143	AI010116	134	AI030010	123	<b>AI1</b>	<b>Pag.</b>
AG010143	143	AI010121	132	AI030011	123	AI10001SP	28
AG010147	117	AI010127	120	AI030020	123	AI10002SP	28
AG010150SC	28	AI010136	135	AI030025	123	AI10003SP	29
AG010154	23	AI010137	120	AI030027	123	<b>ALO</b>	<b>Pag.</b>
AG010159	117	AI010139	132	AI040007	123	AL010006	127
AG010164	117	AI010153	144	AI040008	123	AL010011	127
AG010168	144	AI010166	120	AI040011	123	AL010029	136
AG010169	144	AI010167	120	AI040017	123	AL010038	135
AG010185	142	AI010176	120	AI040018	123	AL010041	135
AG010205	129	AI010195	120	AI040031	123	AL010044	132
AG010207	106	AI020015	120	AI040060	123	AL010053A	136
AG010208	117	AI020019	120	AI050001	123	AL010057	134
AG010219	23	AI020020	120	AI050004	124	AL010070	133
AG010222	23	AI020021	120	AI050004A	124	AL010071	133
AG010225	117	AI020024	120	AI050009A	125	AL010072	136
<b>AG1</b>	<b>Pag.</b>	AI020025	120	AI050022	125	AL010087	136
AG10001SP	28	AI020027	120	AI050024	125	AL010088	136
AG10001SP-W	118	AI020043	121	AI050037	125	AL010099	132
AG10002SC	39	AI020048A	120	AI050040	125	AL010113	144
AG10002SC-W	118	AI020048D	120	AI050042	125	AL010114	144
<b>AH0</b>	<b>Pag.</b>	AI020048E	120	AI050043	125	AL010116	144
AH020002	118	AI020049	121	AI050043S	122	AL010117	144
<b>AIO</b>	<b>Pag.</b>	AI020051	121	AI050071S	132	AL010128	132
AI010006	118	AI020052	121	AI050076	125	AL010175	133
AI010009	118	AI020054	121	AI050077	125	AL010190	135
AI010023	118	AI020056A	121	AI050079	136	AL010196	132
AI010029	118	AI020066	121	AI050080	125	AL010202	137
AI010030	118	AI020092	121	AI050085A	134	AL010203	137
AI010033	126	AI020101A	121	AI050092	125	AL010205	133
AI010037	118	AI020107	121	AI050093	125	AL010218	133
AI010041	119	AI020109	121	AI050096	125	AL010225	137
AI010060	119	AI020113	134	AI050102	126	<b>ANO</b>	<b>Pag.</b>
AI010060-A	119	AI020131	122	AI050104	126	AN010001	127
AI010060-B	119	AI020142	122	AI050109	126	AN010001C	127
AI010060-C	119	AI020154	136	AI050110	145	AN010001D	127
AI010060-D	119	AI020158	145	AI050113	126	AN010009A	125
AI010063A	119	AI020162	122	AI050135	144	AN010030	125
AI010069	136	AI020163	122	AI050152	126	AN010033	127

AN010038	127	AN040105	144	<b>BOU</b>	<b>Pag.</b>	C-A456	19
AN010045	127	AN040126	134	BOUTJW01A	166	C-A7	20
AN010049	128	AN040168	130	BOUTJW02A	166	C-A8	20
AN010054A	128	AN040200	144	BOUTJW03A	166	C-A9	19
AN010054N	128	AN040286	133	BOUTJW04A	166	<b>C-B</b>	<b>Pag.</b>
AN010063	128	<b>AN1</b>	<b>Pag.</b>	BOUTJW05A	167	C-BS Kit1	20
AN010065	128	AN100002SP	29	BOUTJW06A	167	C-BS Kit2	20
AN010066	128	<b>ARO</b>	<b>Pag.</b>	BOUTJW07A	167	C-BS Kit3	20
AN010068	128	AR020016	25	BOUTJW08A	167	<b>C-D</b>	<b>Pag.</b>
AN010072	128	AR020018	130	BOUTJW09A	167	C-DBU1	26
AN010072C	128	AR020019	130	BOUTJW11A	167	C-DM1	106
AN010081A	128	AR020053A	130	BOUTJW12A	167	C-DMH212	71
AN010085A	127	AR020059	25	BOUTJW13A	167	C-DMH314	71
AN010091A	128	AR020059B	25	BOUTJW14A	167	C-DMH414	71
AN010092	128	AR020059C	25	BOUTJW15A	166	C-DS1D	166
AN010106A	128	AR020060	25	BOUTJW16A	167	C-DS4	166
AN010112	128	AR020061	25	<b>C-1</b>	<b>Pag.</b>	C-DS4-H	166
AN010131	129	AR030013	130	C-10DW42	18	C-DS71	166
AN010137	129	AR030022	145	C-13DW53	18	<b>C-H</b>	<b>Pag.</b>
AN010177B	131	AR030024	145	<b>C-3</b>	<b>Pag.</b>	C-HAV	19
AN010186B	129	AR030034	130	C-3DH2	19	C-HA78S	19
AN010187	144	AR030041	130	C-3DH262	19	<b>C-P</b>	<b>Pag.</b>
AN010188A	129	AR030047	130	C-3DH5	18	C-PC1	20
AN010188C	129	AR030058	87	<b>C-4</b>	<b>Pag.</b>	C-PC2	20
AN010202	136	AR030062	130	C-4DWA1	17	C-PC3	20
AN010202B	136	AR040016	131	<b>C-5</b>	<b>Pag.</b>	<b>C-S</b>	<b>Pag.</b>
AN010225	129	AR040043	131	C-5CD	18	C-SA2	16
AN010226	129	AR060002A	131	<b>C-6</b>	<b>Pag.</b>	C-SA2S	16
AN010235	144	AR060003	131	C-6DA4	18	C-SA3	16
AN010237	144	AR060008	131	C-6DA494	18	C-SA3S	16
AN010272	129	AR060011	131	C-6DWB1	17	<b>C-T</b>	<b>Pag.</b>
AN020006	129	AR060020	131	C-6DWB1G	17	C-T12	18
AN020007	129	AR060021	131	C-6DWB5	17	C-T3	18
AN020007-1	129	AR060024A	131	<b>C-7</b>	<b>Pag.</b>	C-T4	26
AN020022	129	AR060029	131	C-7DB2	17	C-T5G-DP	26
AN020022-A	129	AR060032	131	C-7DW1-TS	19	<b>C-W</b>	<b>Pag.</b>
AN020022-B	129	AR060043	131	C-7DW9	17	C-WHEEL1	20
AN020022-C	129	AR060055	131	C-7TOWER	17	C-WHEEL2	20
AN020022-D	129	<b>AS</b>	<b>Pag.</b>	C-7TOWER	17	C-WHEEL5	20
AN040035A	130	AS-0013	158	<b>C-A</b>	<b>Pag.</b>	C-WHEEL6	20
AN040043A	130	AS-0013A2	158	C-A10	20	C-WHEEL8	20
AN040055	145	AS-0013C	158	C-A11	20	C-WHEEL9	20
AN040056	145	AS-0015	158	C-A12	20	<b>CF</b>	<b>Pag.</b>
AN040062	144	AS-0015C	158	C-A13	20	CF-K-C	160
AN040066	144	AS-0026	158	C-A16W	17	CF-K-E	160
AN040082	130	AS-0065	117	C-A17W	17	CF-K-F	160
AN040100	135	<b>BL</b>	<b>Pag.</b>	C-A27	19	CF-K-G	160
AN040101	130	BLACKLINE	9	C-A3	19	CF-K-I	160
						CF-K-J	160



<b>CH</b>	<b>Pag.</b>	D130T50	97	D70S475	90	D71S5125	91
CHAPEIRO1	13	D130T55	97	D70S5100	90	D71S5200	91
<b>D10</b>	<b>Pag.</b>	<b>D15</b>	<b>Pag.</b>	D70S6125	90	D71S5300	91
D10M30M05A	96	D150F5510A	96	D70S6150	90	D71S538	91
D10M30M06A	96	D150F6512A	96	D70S8150	90	D71S575	91
D10M30M08A	96	D150F8012A	96	D70S8175	90	D71S6100	91
D10M30M10A	96	D150H050A	96	D70S9175	90	D71S6150	91
D10M30M12A	96	D150H060B	96	D70S9250	90	D71S638	91
D10M30M14A	96	D150H070B	96	<b>D71</b>	<b>Pag.</b>	D71S6400	91
D10M75M05A	96	D150H080B	96	D71157SV	34	D71S8150	91
D10M75M06A	96	D150P1A	96	D71400T10	92	D71S8200	91
D10M75M08A	96	D150P2A	96	D71400T15	92	D71S8300	91
D10M75M10A	96	D150P3A	96	D71400T20	92	D71S8500	91
D10M75M12A	96	D150T20A	97	D71400T25	92	D71S9175	91
D10M75M14A	96	D150T25A	97	D71400T30	92	D71T10	92
<b>D12</b>	<b>Pag.</b>	D150T27A	97	D715N05	93	D71T107S	93
D125H015A	96	D150T30A	97	D715N08	93	D71T109S	93
D125H020A	96	D150T40A	97	D715N10	93	D71T15	92
D125H025A	96	D150Z1A	96	D715N12	93	D71T20	92
D125H030A	96	D150Z2A	96	D715N13	93	D71T25	92
D125H040A	96	D150Z3A	96	D71C105S	93	D71T27	92
D125H050A	96	<b>D17</b>	<b>Pag.</b>	D71C106S	93	D71T30	92
D125H060A	96	D175H100	96	D71P060	91	D71T40	92
D125P1F	96	D175H120	96	D71P1100	91	D71T45	92
D125P2F	96	D175H40	96	D71P1150	91	D71T5	92
D125T10A	97	D175H50	96	D71P1300	91	D71T50	92
D125T15A	97	D175H60	96	D71P138	91	D71T6	92
D125T20A	97	D175H70	96	D71P180	91	D71T7	92
D125T25A	97	D175H80	96	D71P2100	91	D71T8	92
D125T27A	97	D175T20	97	D71P2150	91	D71T9	92
D125T30A	97	D175T25	97	D71P2250	91	D71Z060	92
D125T40A	97	D175T30	97	D71P238	91	D71Z105S	93
D125Z1A	96	D175T40	97	D71P2400	91	D71Z107S	94
D125Z2A	96	D175T45	97	D71P3150	91	D71Z138	92
D125Z3A	96	D175T50	97	D71P3250	91	D71Z180	92
<b>D13</b>	<b>Pag.</b>	D175T55	97	D71P3400	91	D71Z2100	92
D130H100	96	<b>D37</b>	<b>Pag.</b>	D71P4200	91	D71Z3150	92
D130H120	96	D3750P08S	94	D71PP08KV	36	D71Z4200	92
D130H40	96	D3750T08S	94	D71PP08S	93	<b>D72</b>	<b>Pag.</b>
D130H50	96	D3750T18S	94	D71PP08SP	29	D725N06	92
D130H60	96	D376514SC	39	D71PP16S	93	D725N07	92
D130H70	96	<b>D70</b>	<b>Pag.</b>	D71PP96-EXP	166	D725N08	92
D130H80	96	D70105SP	29	D71S10250	91	D725N08SP	29
D130T20	97	D70P175	90	D71S250	91	D725N09	92
D130T25	97	D70P2100	90	D71S360	91	D725N10	92
D130T30	97	D70P3125	90	D71S4100	91	D725N11	92
D130T40	97	D70P3150	90	D71S4200	91	D725N12	92
D130T45	97	D70PP10S	90	D71S480	91	D725N13	92

<b>D73</b>	<b>Pag.</b>	GM-04AM	164	H06SA180	99	H12S25130	100
D737128SV	34	GM-04PF	164	H06SM209S	99	H12S27145	100
D737134SV	34	GM-04PH	164	<b>H07</b>	<b>Pag.</b>	H12S30165	100
<b>DBT</b>	<b>Pag.</b>	GM-04PM	164	H07M09S	99	H12S40185	100
DBT31B	95	<b>H01</b>	<b>Pag.</b>	<b>H08</b>	<b>Pag.</b>	H12S45205	100
<b>DR0</b>	<b>Pag.</b>	H01B1030	97	H08MTP09S	99	H12S50230	100
DR0107S	94	H01B1040	97	H08S110S	99	<b>H15</b>	<b>Pag.</b>
DR0253S	94	H01B1050	97	H08ST09085	99	H15M105S	100
<b>DV1</b>	<b>Pag.</b>	H01B1060	97	H08ST10090	99	<b>H20</b>	<b>Pag.</b>
DV13P060	107	H01B1070	97	H08ST15100	99	H20MB1037S	100
DV13P180	107	H01B1080	97	H08ST20115	99	H20MT08SP	29
DV13P2100	107	H01B1090	97	H08ST25130	99	H20MT09S	101
DV13P3150	107	H01B1140	97	H08ST27145	99	H20MT10	101
DV13PP07S	107	H01B1170	97	H08ST30165	99	H20MT15	101
DV13PP-TP	90	H01B1190	97	H08ST40185	99	H20MT20	101
DV13S275	107	H01B1220	97	H08ST45205	99	H20MT25	101
DV13S4100	107	H01MH118S	97	H08ST50230	99	H20MT27	101
DV13S5125	107	H01SA109S	98	<b>H10</b>	<b>Pag.</b>	H20MT30	101
DV13S6150	107	H01SA1100	98	H10121SV	34	H20MT40	101
<b>DV4</b>	<b>Pag.</b>	H01SA115	98	H10MB08KV	36	H20MT45	101
DV41M06S	107	H01SA120	98	H10MB08S	99	H20MT50	101
DV41M10	107	H01SA125	98	H10MB08SP	29	<b>H22</b>	<b>Pag.</b>
DV41M13	107	H01SA130	98	H10MB10200	99	H22S109S	101
DV41M5	107	H01SA140	98	H10MB2100	99	<b>HC</b>	<b>Pag.</b>
DV41M6	107	H01SA150	98	H10MB25100	99	HC-100/15	124
DV41M7	107	H01SA160	98	H10MB3100	99	HC-106/15	124
DV41M8	107	H01SA180	98	H10MB4100	99	HC-108/15	124
<b>E</b>	<b>Pag.</b>	H01SA180	98	H10MB5150	99	HC-108/18	124
ELECTR1	11	H01SM109S	98	H10MB6150	99	HC-65/14	124
<b>F</b>	<b>Pag.</b>	<b>H02</b>	<b>Pag.</b>	H10MB8200	99	HC-65/67	124
FITA JW	166	H02MH217S	98	H10MT08KV	36	HC-65103	124
<b>GM</b>	<b>Pag.</b>	H02SM109S	98	H10MT08SP	29	HC-66/6	124
GM-02AF	164	H02SM209S	98	H10MT09S	100	HC-68/14	124
GM-02AH	164	<b>H03</b>	<b>Pag.</b>	H10MT10100	100	HC-73/14	124
GM-02AM	164	H03MH118S	98	H10MT15100	100	HC-74/15	124
GM-02BH	164	H03SM109S	98	H10MT20100	100	HC-74/76	124
GM-02BPH	164	<b>H05</b>	<b>Pag.</b>	H10MT25100	100	HC-75/77	124
GM-02PF	164	H05SA109S	98	H10MT27150	100	HC-76/12	124
GM-02PH	164	<b>H06</b>	<b>Pag.</b>	H10MT30150	100	HC-76/14	124
GM-02PM	164	H06MT109S	98	H10MT40150	100	HC-76/30	124
GM-03AF	164	H06SA109S	99	H10MT45200	100	HC-76/8	124
GM-03AH	164	H06SA1100	99	H10MT50200	100	HC-78/15	124
GM-03AM	164	H06SA115	99	<b>H12</b>	<b>Pag.</b>	HC-80/15	124
GM-03PF	164	H06SA120	99	H12S09085	100	HC-80/82	124
GM-03PH	164	H06SA125	99	H12S10090	100	HC-86/16	124
GM-03PM	164	H06SA130	99	H12S110S	100	HC-86/18	124
GM-04AF	164	H06SA140	99	H12S15100	100	HC-9.5mm	124
GM-04AH	164	H06SA150	99	H12S20115	100	HC-90/15	124
		H06SA160	99				

HC-92/10	124	JAD-1027-RK	152	JAI-1124	148	JAS-1031-6HP	156
HC-93/15	124	JAD-6252A	152	JAI-1124-RK	148	JAS-1031-6VE-RK	156
HC-93/36	124	JAD-6252A-RK	152	JAI-1138	150	JAS-1206-6HE	155
HC-93/45	124	<b>JAG</b>	<b>Pag.</b>	JAI-1138L	150	JAS-1206-6HE-RK	155
HC-95/15	124	JAG-0903-MS	153	JAI-1138-RK	150	JAS-1206-6HP	155
HC-96/18	124	JAG-0906RMk-RK	153	JAI-1206L	150	JAS-1207-6HE	156
<b>JA</b>	<b>Pag.</b>	JAG-0906RMK	153	JAI-1206L-RK	150	JAS-1207-6HE-RK	156
JA-0001RK	158	JAG-0913RMK	153	JAI-1232K	148	JAS-1231-HE	156
JA-300C-28	158	JAG-0913RM-RK	153	JAI-1232-RK	148	JAS-1231-HE-RK	156
JA-300C-NS13	157	JAG-0923RM	154	JAI-1408	150	JAS-6505	154
JA-3806C	158	JAG-0923RM-RK	154	JAI-1408L	151	JAS-6505-RK	154
JA-3808A	158	JAG-0925RM	154	JAI-1408-RK	150	JAS-6531	156
JA-5032	162	JAG-0925RM-RK	154	JAI-6202K	148	JAS-6531-RK	156
JA-6111	157	JAG-0955RM	154	JAI-6202-RK	148	JAS-6535-5HE	156
JA-6111K	157	JAG-0955RM-RK	154	JAI-6211	150	JAS-6535-5HE-RK	156
JA-6111-NS13	157	JAG-6638	154	JAI-6211-RK	150	JAS-6535-5VE-RK	156
JA-6111-NS17	157	JAG-6638-RK	154	JAI-6212K	150	JAS-6535-6HE	156
JA-6111-NS20	157	JAG-6639	154	JAI-6212-RK	150	JAS-6535-6HE-RK	156
JA-7253	163	JAG-6639-RK	154	JAI-6266	149	JAS-6542	159
JA-7254	163	<b>JAH</b>	<b>Pag.</b>	JAI-6266-RK	149	JAS-6542-RK	159
JA-950	158	JAH-0288	161	<b>JAR</b>	<b>Pag.</b>	JAS-6543	159
JA-950-04	158	JAH-0288-15	161	JAR-1012	151	JAS-6543-RK	159
JA-960	158	JAH-0288-16	161	JAR-1012-RK	151	JAS-6551	154
JA-C131SV	34	JAH-0288-17	161	JAR-1013	151	JAS-6551-RK	154
JA-HVLP-1080GK	157	JAH-0288-RK	161	JAR-1013-RK	151	JAS-6552	155
JA-HVLP-3000-NS17	157	JAH-6837	161	JAR-1033	152	JAS-6552-RK	155
JA-HVLP-3000-NS19	157	JAH-6837-50	161	JAR-1033-RK	152	<b>JAT</b>	<b>Pag.</b>
JA-HVLP-300C1.3	157	JAH-6837-50-2	161	JAR-1094	151	JAT-1011	159
JA-HVLP-6112	157	JAH-6837-RK	161	JAR-1094-RK	151	JAT-1011-RK	159
JA-LVLP-0303W	157	JAH-7104H	161	JAR-6309AK	151	JAT-1020K	159
JA-LVLP-0303W-N	157	JAH-7104H-RK	161	JAR-6309ARK		JAT-1020-RK	159
<b>JAB</b>	<b>Pag.</b>	<b>JAI</b>	<b>Pag.</b>	151JAR-6310A	151	JAT-1035	162
JAB-1017	152	JAI-0501K	149	JAR-6310AK	151	JAT-1035-RK	162
JAB-1017-RK	152	JAI-0501-RK	149	JAR-6310A-RK	151	JAT-1041	159
JAB-1018	153	JAI-0926	149	<b>JAS</b>	<b>Pag.</b>	JAT-1041-16S	159
JAB-1018-RK	153	JAI-0926-RK	149	JAS-0010	155	JAT-10T18	160
JAB-7003A	153	JAI-0936	149	JAS-0010-41	155	JAT-10T32	160
JAB-7003A-RK	153	JAI-0936-RK	149	JAS-0010-RK	155	JAT-12F1	159
<b>JAD</b>	<b>Pag.</b>	JAI-0938	150	JAS-0413	155	JAT-12F2	159
JAD-0413	152	JAI-0938-RK	150	JAS-0413-RK	155	JAT-12F3	159
JAD-0413-RK	152	JAI-0963	149	JAS-0423K	155	JAT-12F4	159
JAD-1015K	153	JAI-0963-RK	149	JAS-0423-RK	155	JAT-20T14	159
JAD-1015-RK	153	JAI-1024	148	JAS-0452	158	JAT-20T18	159
JAD-1020	152	JAI-1024-RK	148	JAS-0452-RK	159	JAT-20T24	159
JAD-1020-RK	152	JAI-1054	149	JAS-1021-6HE(2.5)	155	JAT-460	162
JAD-1021	152	JAI-1054-RK	149	JAS-1021-6HE-RK	155	JAT-480	162
JAD-1021-RK	152	JAI-1114	148	JAS-1031-6HE	156	JAT-480-NS	162
JAD-1027	152	JAI-1114-RK	148	JAS-1031-6HE-RK	156	JAT-501	162

JAT-6004K	162	JAZ-6710A	164	<b>M29</b>	<b>Pag.</b>	<b>M64</b>	<b>Pag.</b>
JAT-6034	162	JAZ-6711A	164	M2927	102	M64105	103
JAT-6034-RK	162	JAZ-6712A	164	M2927-T1	102	M64105S	104
JAT-6412	161	JAZ-7207	153	M2927-T2	102	M645114SP	30
JAT-6412-RK	161	JAZ-7214F	164	M2940	102	M64M105S	104
JAT-6421	160	JAZ-7214S	164	M2940-T1	102	<b>ME0</b>	<b>Pag.</b>
JAT-6421-33	160	JAZ-7214Z	164	M2940-T2	102	ME010001	137
JAT-6421-RK	160	<b>JEI</b>	<b>Pag.</b>	<b>M60</b>	<b>Pag.</b>	ME010007	137
JAT-6441K	160	JEI-0004S	26	M60102	103	ME010009	137
JAT-6441-RK	160	<b>JEZ</b>	<b>Pag.</b>	M60104	103	ME010010	137
JAT-6613	160	JEZ-18D	26	M60105	103	ME010012	137
JAT-6673	162	<b>KIT</b>	<b>Pag.</b>	<b>M61</b>	<b>Pag.</b>	ME020001	137
JAT-6673-RK	162	KIT AR	164	M61110	103	ME020002	137
JAT-6676	160	<b>M03</b>	<b>Pag.</b>	M61112	103	ME020003	138
JAT-6676-RK	160	M03025	102	M61113	103	ME020005	138
JAT-6904S	163	<b>M04</b>	<b>Pag.</b>	M61116	103	ME020006	138
JAT-6905B	163	M04008	102	M61119	103	<b>MEC</b>	<b>Pag.</b>
JAT-6905C	163	M04012	102	M61122	103	MEC PESADOS	15
JAT-6905J	163	M04016	102	M61125	103	MEC SOLUTION	7
JAT-6943A	161	M04024	102	M61H116	104	MECPOWER	8
JAT-6943A-RK	161	M04032	102	M61H119	104	MECPOWER EVA17	6
JAT-6952	160	<b>M05</b>	<b>Pag.</b>	M61H124	104	MECPROF1	10
JAT-6952P	161	M05020	102	<b>M62</b>	<b>Pag.</b>	<b>MF0</b>	<b>Pag.</b>
JAT-6952P-37	161	<b>M06</b>	<b>Pag.</b>	M62102	103	MF05A	104
JAT-6952P-39	161	M06030	102	M62103	103	MF05B	104
JAT-6952P-40	161	M06040	102	M62104	103	MF05C	104
JAT-6952P-RK	161	<b>M07</b>	<b>Pag.</b>	M62105	103	MF05D	104
JAT-6952-RK	160	M07016	102	M62106	103	MF05E	104
JAT-6959	163	M07016-ACE	102	M62108	103	MF05S	104
JAT-6959A	163	M07016-TPR	102	M62H102	104	<b>MFM</b>	<b>Pag.</b>
<b>JAZ</b>	<b>Pag.</b>	<b>M09</b>	<b>Pag.</b>	M62H103	104	MFM06S	104
JAZ-0002A	163	M09100	102	M62H104	104	<b>MG0</b>	<b>Pag.</b>
JAZ-0002B	163	M091000	102	M62H106	104	MG010001	138
JAZ-0002C	163	M09103KV	36	<b>M63</b>	<b>Pag.</b>	MG010002	138
JAZ-011H	162	M09200	102	M63102	103	MG010003	138
JAZ-016H	162	M09300	102	M63103	103	MG010004	138
JAZ-0512	163	M09500	102	M63104	103	MG010005	138
JAZ-0513	163	M09513SP	30	M63105	103	MG010006	138
JAZ-0513-09	163	M09800	102	M63106	103	MG010008	138
JAZ-0513-50	163	<b>M10</b>	<b>Pag.</b>	M63106	103	MG010009	138
JAZ-0514	163	M10110	142	M63106S	104	MG020001	138
JAZ-0514-09	163	M10210A	142	M63108	103	MG020003	138
JAZ-0514-48	163	M10210B	142	M63113KV	37	MG020004	138
JAZ-0516	163	M10410A	142	M63H103	104	MG020006	138
JAZ-39520	163	M10410B	142	M63H105	104	MG020007	138
JAZ-6704A	163	<b>M11</b>	<b>Pag.</b>	M63H106	104	MG020008	138
JAZ-6704-O	164	M11035	102	M63H108	104	<b>MH</b>	<b>Pag.</b>
JAZ-6704-W	164	M11045	102	M63M106S	104	MHS08KV	37
		M11065	102			MHS100AG	104

<b>MI0</b>	<b>Pag.</b>	MTC1300	105	<b>P12</b>	<b>Pag.</b>	<b>P38</b>	<b>Pag.</b>
MI010014	138	MTC153	105	P1216	85	P38M09A	88
MI010016	138	MTC156	105	P1218	85	P38M11A	88
MI010017	139	MTC200	105	<b>P14</b>	<b>Pag.</b>	<b>P40</b>	<b>Pag.</b>
MI010018	139	MTC306	105	P1416	85	P4016	85
MI010019	139	MTC308	105	<b>P15</b>	<b>Pag.</b>	<b>P43</b>	<b>Pag.</b>
MI010020	139	MTC408	105	P1516	85	P4318	86
MI010021	139	MTC508	105	<b>P17</b>	<b>Pag.</b>	P4318-RK	86
MI020001	139	<b>MTM</b>	<b>Pag.</b>	P178	86	P4330	86
MI020002	139	MTM1025	106	<b>P18</b>	<b>Pag.</b>	P4330-RK	86
MI020004	139	MTM1050	106	P1810	86	<b>P52</b>	<b>Pag.</b>
<b>MK2</b>	<b>Pag.</b>	MTM1075	106	<b>P20</b>	<b>Pag.</b>	P52M10	88
MK2040	105	MTM1100	106	P2010LA	86	P52N10	88
MK2040-B	105	<b>P01</b>	<b>Pag.</b>	P2010RA	86	<b>P53</b>	<b>Pag.</b>
MK2080	105	P011804KV	37	P2010SA	86	P53M06	88
<b>MKS</b>	<b>Pag.</b>	P018	83	<b>P22</b>	<b>Pag.</b>	P53M11	88
MKS27	105	P018SP	30	P2205E	86	P53M18	88
MKS27-12	105	P018SP1	30	P2208A	86	<b>P54</b>	<b>Pag.</b>
MKS27-16	105	<b>P03</b>	<b>Pag.</b>	P2212A	86	P54M08A	88
MKS27-16A	105	P038	83	<b>P27</b>	<b>Pag.</b>	P54M10A	88
MKS27-20	105	<b>P04</b>	<b>Pag.</b>	P2706	83	<b>P60</b>	<b>Pag.</b>
<b>MKV</b>	<b>Pag.</b>	P046	83	P2710	83	P6008	83
MKV7	107	P04704SP	30	P2712	83	<b>P61</b>	<b>Pag.</b>
MKV7-K	107	<b>P05</b>	<b>Pag.</b>	P2710SP	30	P6106	83
MKV8	107	P0516	85	<b>P28</b>	<b>Pag.</b>	P6108	83
<b>MN</b>	<b>Pag.</b>	P0518	85	P2803SP	31	P6116	85
MN020004	139	<b>P06</b>	<b>Pag.</b>	P2810	83	<b>P64</b>	<b>Pag.</b>
MN020005	139	P068	83	P28110	85	P6424	86
<b>MS</b>	<b>Pag.</b>	P068A	83	P28112	85	<b>P71</b>	<b>Pag.</b>
MSH1214	71	<b>P07</b>	<b>Pag.</b>	P28210	85	P7101	84
MSH1414	71	P079	83	P28212	85	P7102	84
MSH3814	71	<b>P08</b>	<b>Pag.</b>	<b>P30</b>	<b>Pag.</b>	P7103	84
<b>MT0</b>	<b>Pag.</b>	P0803SP	30	P30M07C	88	P7104	84
MT010001	139	P0813SC	39	P30M10A	88	P7105	84
MT010002	139	P0816	85	<b>P32</b>	<b>Pag.</b>	<b>P76</b>	<b>Pag.</b>
MT010003	139	P0817	85	P32M03S	89	P7601	86
MT010004	123	P0818	85	P32M05C	88	P7602	86
MT010005	139	<b>P09</b>	<b>Pag.</b>	P32M07A	88	P7603	96
MT010006	139	P0903SP	30	P32M105KV	37	P7608	86
MT010007	139	P0916	85	P32M10A	88	<b>P77</b>	<b>Pag.</b>
MT010008	139	P0918	85	P32M10C	88	P7719	86
MT0204	105	<b>P10</b>	<b>Pag.</b>	<b>P36</b>	<b>Pag.</b>	<b>P78</b>	<b>Pag.</b>
MT0701	105	P1016	85	P36M06C	88	P7801	89
MT0702	105	P1017	85	P36M09A	88	P7802	89
<b>MTC</b>	<b>Pag.</b>	P1019	88	P36M09C	88	P7803	89
MTC101SP	30	<b>P11</b>	<b>Pag.</b>	<b>P37</b>	<b>Pag.</b>	P7804	89
MTC1150	105	P1116	85	P37M11A	88	P7805	89
MTC1200	105	P1118	85	P37M18A	88	P78M10C	89

<b>P80</b>	<b>Pag.</b>	<b>PSV</b>	<b>Pag.</b>	<b>R19</b>	<b>Pag.</b>	<b>R48</b>	<b>Pag.</b>
P8006	84	PSV108SP	108	R19H310S	75	R4802A	45
<b>P81</b>	<b>Pag.</b>	PSV110SC	108	R19H3110	75	R4802RK	46
P8106	84	<b>P-TR</b>	<b>Pag.</b>	R19H3111	75	R4804A	45
<b>P82</b>	<b>Pag.</b>	P-TR(AG010002SP)	42	R19H3112	75	R4804RK	46
P82714SV	34	P-TR(AG010026SP)	42	R19H3113	75	R4811SC	39
P82736SV	34	P-TR(AI10002SP)	42	R19H3114	75	<b>R51</b>	<b>Pag.</b>
<b>P86</b>	<b>Pag.</b>	P-TR(D70105SP)	42	R19H3115	75	R5104	45
P8606	84	P-TR(D70SP06ST)	42	R19H3116	75	R5104RK	46
<b>P90</b>	<b>Pag.</b>	P-TR(D71PP08ST)	42	R19H3117	75	<b>R53</b>	<b>Pag.</b>
P9006	84	P-TR(H10MB08SP)	42	R19H3118	75	R53A	74
<b>P94</b>	<b>Pag.</b>	P-TR(M09513SP)	42	R19H3119	75	R53A-3A	74
P9409	88	P-TR(M645114SP)	42	<b>R2</b>	<b>Pag.</b>	R53A-4A	74
<b>P95</b>	<b>Pag.</b>	P-TR(P04704SP)	42	R2902	44	<b>R58</b>	<b>Pag.</b>
P9506	83	P-TR(P0803SP)	42	R2902RK	46	R5802ERK	46
<b>P96</b>	<b>Pag.</b>	P-TR(PC303ST)	42	R2903RK	46	R5803RK	46
P9601	104	P-TR(S03A4122SP)	42	R2904	44	R5804ERK	46
<b>P-B</b>	<b>Pag.</b>	P-TR(S04H2125SP)	42	R2904RK	46	R5804LRK	46
P-B (31)	42	P-TR(S04H3157SP)	42	<b>R34</b>	<b>Pag.</b>	<b>R66</b>	<b>Pag.</b>
P-B (41)	42	P-TR(S04H3536SP)	42	R3402RK	46	R6602	45
<b>P-EVA</b>	<b>Pag.</b>	P-TR(S04H4120ST)	42	R3403	46	R6603	45
P-EVA(D71PP08KV)	41	P-TR(S04H4125SP)	42	R3403RK	46	R6604	45
P-EVA(D7371234SV)	40	P-TR(S04H4506ST)	42	R3404RK	46	<b>RD0</b>	<b>Pag.</b>
P-EVA(D737128SV)	40	P-TR(S04H4726SP)	42	<b>R35</b>	<b>Pag.</b>	RD01032S	95
P-EVA(H10121SV)	40	P-TR(S04H4728SP)	42	R3502	45	<b>RV0</b>	<b>Pag.</b>
P-EVA(H10MB08KV)	41	P-TR(S06H427SP)	42	R3503	45	RV032	110
P-EVA(H10MT08KV)	41	P-TR(S09H4118SP)	42	R3504	45	RV033	110
P-EVA(M09103KV)	41	P-TR(S29H4140SP)	42	<b>R36</b>	<b>Pag.</b>	RV034	110
P-EVA(M63113KV)	41	P-TR(W23108SP)	42	R3602	45	<b>S01</b>	<b>Pag.</b>
P-EVA(MHS08KV)	41	P-TR(W25110SP)	42	R3602RK	46	S01U4108S	75
P-EVA(P011804KV)	41	P-TR(W26107ST)	42	R3603	45	S01U4113	75
P-EVA(P32M105KV)	41	P-TR(W26112SP)	42	R3603RK	46	S01U4114	75
P-EVA(P82714SV)	40	P-TR(W26116SP)	42	R3604RK	46	S01U4115	75
P-EVA(P82736SV)	40	P-TR(W26920ST)	42	<b>R37</b>	<b>Pag.</b>	S01U4116	75
P-EVA(S03A4122KV)	41	<b>PV0</b>	<b>Pag.</b>	R3702	45	S01U4117	75
P-EVA(S04H2132KV)	41	PV018	108	R3702B	45	S01U4119	75
P-EVA(S04H4144KV)	41	PV0518	108	R3703	45	S01U4121	75
P-EVA(S04H4295SV)	40	PV068	108	R3704	45	S01U4122	75
P-EVA(S04H45121SV)	40	<b>PV1</b>	<b>Pag.</b>	R3704B	45	<b>S03</b>	<b>Pag.</b>
P-EVA(S29H4141KVV)	41	PV1118	108	<b>R41</b>	<b>Pag.</b>	S03A2110	75
P-EVA(W23559SV)	40	PV1416	108	R4103	45	S03A2112	75
P-EVA(W25110KV)	41	PV1516	108	R4104	45	S03A2114	75
P-EVA(W26116KV)	41	<b>PV4</b>	<b>Pag.</b>	<b>R45</b>	<b>Pag.</b>	S03A4109	75
P-EVA(W26134SV)	40	PV4006	108	R4502	45	S03A4110	75
P-EVA(W2623431SV)	40	<b>R12</b>	<b>Pag.</b>	R4502JRK	46	S03A4111	75
<b>PI</b>	<b>Pag.</b>	R1206	44	R4502RK	46	S03A4111S	75
PINTOR16	14	R1206R	46			S03A4112	75
		R12081	44			S03A4113	75
		R12081RK	46				

S03A4114	75	S03A6150	77	S03A8190	79	S03AD6140	78
S03A4115	75	S03A6151	77	S03A8192	79	S03AD6141	78
S03A4116	75	S03A6152	77	S03A8195	79	S03AD6142	78
S03A4117	75	S03A6153	77	S03A8A6	79	S03AD6146	78
S03A4118	75	S03A6154	77	S03A8E04	79	S03AD6150	78
S03A4119	75	S03A6155	77	S03A8E07	79	S03AD8107S	79
S03A4121	75	S03A6156	77	S03A8E10	79	S03AD8117	80
S03A4122	75	S03A6157	77	S03AD4110	76	S03AD8124	80
S03A4122KV	37	S03A6158	77	S03AD4111	76	S03AD8126	80
S03A4122SP	31	S03A6159	77	S03AD4111S	76	S03AD8127	80
S03A4123	75	S03A6160	77	S03AD4112	76	S03AD8129	80
S03A4124	75	S03A6163	77	S03AD4113	76	S03AD8130	80
S03A4127	75	S03A6165	77	S03AD4114	76	S03AD8132	80
S03A4129	75	S03A6167	77	S03AD4115	76	S03AD8133	80
S03A4130	75	S03A6170	77	S03AD4116	76	S03AD8134	80
S03A4132	75	S03A6A4	78	S03AD4117	76	S03AD8135	80
S03A4211S	76	S03A6A8	78	S03AD4118	76	S03AD8136	80
S03A4A3	76	S03A6E04	78	S03AD4119	76	S03AD8138	80
S03A4A6	76	S03A6E08	78	S03AD4121	76	S03AD8140	80
S03A4E4	76	S03A6E10	78	S03AD4122	76	S03AD8141	80
S03A4E5	76	S03A6U6	78	S03AD4124	76	S03AD8142	80
S03A4E6	76	S03A8109S	79	S03AD4126	76	S03AD8146	80
S03A4E8	76	S03A8124	79	S03AD4127	76	S03AD8148	80
S03A4U4	76	S03A8127	79	S03AD4128	76	S03AD8150	80
S03A4UT3S	76	S03A8129	79	S03AD4130	76	S03AD8155	80
S03A6108S	77	S03A8130	79	S03AD4132	76	S03AD8158	80
S03A6126	77	S03A8132	79	S03AD4303S	81	S03AD8160	80
S03A6127	77	S03A8133	79	S03AD4307S	82	S03AD8165	80
S03A6129	77	S03A8134	79	S03AD4317	81	S03H2327S	55
S03A6130	77	S03A8135	79	S03AD4319	81	S03S8117	80
S03A6132	77	S03A8136	79	S03AD4321	81	S03S8119	80
S03A6133	77	S03A8138	79	S03AD4414S	76	S03S8121	80
S03A6134	77	S03A8140	79	S03AD4503S	82	S03SD8117	80
S03A6135	77	S03A8141	79	S03AD4517	82	S03SD8119	80
S03A6136	77	S03A8144	79	S03AD4519	82	S03SD8121	80
S03A6137	77	S03A8146	79	S03AD4521	82	S03V2106	108
S03A6138	77	S03A8150	79	S03AD6107S	78	S03V2108	108
S03A6139	77	S03A8155	79	S03AD6120S	78	S03V2110	108
S03A6140	77	S03A8160	79	S03AD6126	78	S03V2114	108
S03A6141	77	S03A8165	79	S03AD6127	78	S03V3108	108
S03A6142	77	S03A8170	79	S03AD6129	78	S03V3110	108
S03A6143	77	S03A8173	79	S03AD6130	78	S03V3112	108
S03A6144	77	S03A8175	79	S03AD6132	78	S03V3113	108
S03A6145	77	S03A8176	79	S03AD6133	78	S03V3114	108
S03A6146	77	S03A8178	79	S03AD6134	78	S03V3117	108
S03A6147	77	S03A8180	79	S03AD6135	78	S03V3119	108
S03A6148	77	S03A8185	79	S03AD6136	78	S03V3122	108
S03A6149	77	S03A8189	79	S03AD6138	78	S03V3116SC	109

S03V4110	109	S04H3124	60	S04H52460S	57	S04H6430	63
S03V4111	109	S04H3125S	55	S04H52477S	58	S04H6432	63
S03V4112	109	S04H3141S	55	S04H52478S	58	S04H6433	63
S03V4113	109	S04H3157S	56	S04H6115S	56	S04H6435	63
S03V4114	109	S04H3157SP	31	S04H6119	62	S04H6436	63
S03V4117	109	S04H3194SV	35	S04H6121	62	S04H6438	63
S03V4119	109	S04H3536S	55	S04H6121S	56	S04H6440	63
S03V4120SC	109	S04H3536SP	31	S04H6122	62	S04H6441	63
S03V4122	109	S04H4108	61	S04H6124	62	S04H6443	63
S03V4124	109	S04H4109	61	S04H6127	62	S04H6444	63
S03V4127	109	S04H4110	61	S04H6128	62	S04H6446	63
S03V4132	109	S04H4111	61	S04H6130	62	S04H6447	63
<b>S04</b>	<b>Pag.</b>	S04H4112	61	S04H6132	62	S04H6450	63
S04H2104	60	S04H4113	61	S04H6134	62	S04H6456	63
S04H21045	60	S04H4114	61	S04H6136	62	S04H8115S	56
S04H2105	60	S04H4115	61	S04H6138	62	S04H8355	64
S04H21055	60	S04H4116	61	S04H6141	62	S04H8360	64
S04H2106	60	S04H4117	61	S04H6146	62	S04H8365	64
S04H2107	60	S04H4118	61	S04H6150	62	S04HD2106	60
S04H2108	60	S04H4119	61	S04H624101S	59	S04HD2107	60
S04H2109	60	S04H4120	61	S04H6319	63	S04HD2108	60
S04H2110	60	S04H4121	61	S04H6321	63	S04HD2110	60
S04H2111	60	S04H4122	61	S04H6322	63	S04HD2111	60
S04H2112	60	S04H4123	61	S04H6323	63	S04HD2112	60
S04H2113	60	S04H4124	61	S04H6324	63	S04HD2113	60
S04H2114	60	S04H4125	61	S04H6325	63	S04HD3110	61
S04H2118S	55	S04H4125S	56	S04H6326	63	S04HD3111	61
S04H2125SP	31	S04H4125SP	31	S04H6327	63	S04HD3112	61
S04H2132KV	37	S04H4126	61	S04H6329	63	S04HD3113	61
S04H2141S	55	S04H4127	61	S04H6330	63	S04HD3114	61
S04H2184SV	35	S04H4128	61	S04H6332	63	S04HD3115	61
S04H3106	60	S04H4129	61	S04H6334	63	S04HD3117	61
S04H3107	60	S04H4130	61	S04H6336	63	S04HD3119	61
S04H3108	60	S04H4131SP	32	S04H6338	63	S04HD3121	61
S04H3109	60	S04H4132	61	S04H6341	63	S04HD4109	62
S04H3110	60	S04H4134	61	S04H6346	63	S04HD4110	62
S04H3111	60	S04H4136	61	S04H6350	63	S04HD4111	62
S04H3112	60	S04H4144KV	37	S04H6355	63	S04HD4112	62
S04H3113	60	S04H42165SV	35	S04H6356	63	S04HD4113	62
S04H3114	60	S04H4295SV	35	S04H6360	63	S04HD4114	62
S04H3115	60	S04H4524S	56	S04H6365	63	S04HD4115	62
S04H3116	60	S04H4524SP	32	S04H6419	63	S04HD4116	62
S04H3117	60	S04H46121SV	35	S04H6421	63	S04HD4117	62
S04H3118	60	S04H4726SP	32	S04H6422	63	S04HD4118	62
S04H3119	60	S04H4728S	56	S04H6424	63	S04HD4119	62
S04H3120	60	S04H4728SP	32	S04H6426	63	S04HD411S	62
S04H3121	60	S04H5129SC	39	S04H6427	63	S04HD4120	62
S04H3122	60	S04H524127S	59	S04H6429	63	S04HD4121	62



S04HD4122	62	S05HD4122	64	S07H225	66	S09H206	68
S04HD4123	62	S05HD4123	64	S07H227	66	S09H207	68
S04HD4124	62	S05HD4124	64	S07H230	66	S09H303	68
S04HD4125	62	S05HD4127	64	S07H240	66	S09H304	68
S04HD4126	62	S05HD4130	64	S07H310	67	S09H305	68
S04HD4127	62	S05HD4132	64	S07H315	67	S09H306	68
S04HD4128	62	S05HD4213S	65	S07H320	67	S09H307	68
S04HD4130	62	<b>S06</b>	<b>Pag.</b>	S07H325	67	S09H308	68
S04HD4132	62	S06A408S	81	S07H327	67	S09H310	68
<b>S05</b>	<b>Pag.</b>	S06A4T20	81	S07H330	67	S09H312	68
S05A408S	81	S06A4T27	81	S07H340	67	S09H314	68
S05A4H10	80	S06A4T30	81	S07H345	67	S09H404	68
S05A4H12	80	S06A4T40	81	S07H350	67	S09H405	68
S05A4H14	80	S06A4T45	81	S07H355	67	S09H406	68
S05A4H17	80	S06A4T50	81	S07H360	67	S09H407	68
S05A4H18	80	S06A4T55	81	S07H4109S	67	S09H408	68
S05A4H19	80	S06A4T60	81	S07H420	67	S09H410	68
S05A4H4	80	S06A4T70	81	S07H425	67	S09H4109S	57
S05A4H5	80	S06A4T80	81	S07H427	67	S09H4118SP	32
S05A4H6	80	S06H204	66	S07H430	67	S09H412	68
S05A4H8	80	S06H205	66	S07H4320	67	S09H414	68
S05H4113S	64	S06H206	66	S07H4325	67	S09H416	68
S05H4213S	64	S06H207	66	S07H4327	67	S09H417	68
S05H4811	64	S06H208	66	S07H4330	67	S09H419	68
S05H4812	64	S06H210	66	S07H4340	67	S09H4304	68
S05H4813	64	S06H211	66	S07H4345	67	S09H4305	68
S05H4814	64	S06H37S	65	S07H4350	67	S09H4306	68
S05H4816	64	S06H410	66	S07H4352	67	S09H4307	68
S05H4818	64	S06H411	66	S07H4355	67	S09H4308	68
S05H4819	64	S06H412	66	S07H4360	67	S09H4309	68
S05H4820	64	S06H4127S	56	S07H4370	67	S09H4310	68
S05H4821	64	S06H414	66	S07H440	67	S09H4312	68
S05H4822	64	S06H416	66	S07H445	67	S09H4314	68
S05H4824	64	S06H418	66	S07H450	67	S09H4316	68
S05H4825	64	S06H420	66	S07H4530	67	S09H4317	68
S05H4827	64	S06H422	66	S07H4540	67	S09H4319	68
S05H4830	64	S06H424	66	S07H4545	67	S09V3H4	109
S05H4832	64	S06H425S	57	S07H455	67	S09V3H5	109
S05HD4110	64	S06H427SP	32	S07H460	67	S09V3H6	109
S05HD4111	64	S06H49S	65	S07H470	67	S09V3H8	109
S05HD4112	64	<b>S07</b>	<b>Pag.</b>	S07H4932S	57	S09V41H4	109
S05HD4113	64	S07H206	66	<b>S08</b>	<b>Pag.</b>	S09V41H5	109
S05HD4113S	65	S07H207	66	S08H208S	95	S09V41H6	109
S05HD4117	64	S07H208	66	S08H311S	67	S09V41H8	109
S05HD4118	64	S07H209	66	<b>S09</b>	<b>Pag.</b>	S09V41H10	109
S05HD4119	64	S07H210	66	S09H203	68		
S05HD4120	64	S07H215	66	S09H204	68		
S05HD4121	64	S07H220	66	S09H205	68		

<b>S10</b>	<b>Pag.</b>	<b>S16</b>	<b>Pag.</b>	S23H41300	73	<b>S44</b>	<b>Pag.</b>
S10H230	69	S16H1234	72	S23H6450	73	S44H2206	74
S10H235	69	S16H1238	72	S23H6500	73	S44H3110A	74
S10H240	69	S16H1438	72	S23H8550	73	S44H4110	74
S10H245	69	S16H302	72	<b>S24</b>	<b>Pag.</b>	<b>S46</b>	<b>Pag.</b>
S10H250	69	S16H304	72	S24H2100	73	S46TE80	82
S10H255	69	S16H3410	72	S24H2150	73	<b>S49</b>	<b>Pag.</b>
S10H260	69	S16H3412	72	S24H250	73	S49H4105	71
S10H270	69	S16H3812	72	S24H3150	73	S49H4106	71
S10H3100	69	S16H3814	72	S24H3200	73	S49H4108	71
S10H3120	69	S16H403	72	S24H375	73	S49H4110	71
S10H340	69	<b>S17</b>	<b>Pag.</b>	S24H4125	73	S49H4112	71
S10H350	69	S17H3116	72	S24H4250	73	S49H4114	71
S10H355	69	S17H3121	72	S24H450	73	S49H4116	71
S10H360	69	S17H3414	72	S24H475	73	S49H4308	71
S10H370	69	S17H4116	72	S24H6100	73	S49H4310	71
S10H380	69	S17H4121	72	S24H6200	73	S49H4312	71
S10H4100	69	<b>S18</b>	<b>Pag.</b>	S24H6400	73	S49H4314	71
S10H4110	69	S18A4103MS	81	<b>S25</b>	<b>Pag.</b>	S49H4318	71
S10H4120	69	S18A4115	82	S25V310	109	<b>S50</b>	<b>Pag.</b>
S10H480	69	S18A4117	82	S25V36	109	S50H3106S	70
S10H490	69	S18A4117M	81	S25V410	109	S50H3206S	70
<b>S11</b>	<b>Pag.</b>	S18A4119	82	S25V45	109	<b>S54</b>	<b>Pag.</b>
S11H200	69	S18A4119M	81	<b>S26</b>	<b>Pag.</b>	S54H5509S	70
S11H201	69	S18A4121	82	S26H2150	74	<b>S57</b>	<b>Pag.</b>
S11H202	69	S18A4121M	81	S26H2280	74	S57H108	51
S11H203	69	S18AD4117	82	<b>S27</b>	<b>Pag.</b>	S57H108S	51
S11H300	70	S18AD4119	82	S27H2	73	S57H110	51
S11H301	70	S18AD4121	82	S27H3	73	S57H111	51
S11H302	70	<b>S21</b>	<b>Pag.</b>	S27H4	73	S57H113	51
S11H303	70	S21H41125	72	<b>S29</b>	<b>Pag.</b>	S57H115	51
S11H304	70	S21H41250	72	S29H2133S	95	S57H116	51
S11H402	70	S21H4150	72	S29H2180S	97	S57H117	51
S11H403	70	S21H4175	72	S29H4140SP	32	S57H118	51
S11H404	70	<b>S22</b>	<b>Pag.</b>	S29H4141KV	38	S57H119	51
<b>S12</b>	<b>Pag.</b>	S22H31200	73	<b>S40</b>	<b>Pag.</b>	S57H121	51
S12A4525S	81	S22H41375	73	S40T109S	74	S57H123	51
<b>S14</b>	<b>Pag.</b>	S22H41375RK	73	<b>S41</b>	<b>Pag.</b>	S57H125	51
S14A4108S	95	S22H41450	73	S41H41	74	S57H127	51
S14A4117	95	S22H41450RK	73	<b>S42</b>	<b>Pag.</b>	S57H132	51
S14A4118	95	S22H41600	73	S42M403S	73	<b>S60</b>	<b>Pag.</b>
S14A4121	95	S22H41600RK	73	S42M4125	73	S60H4304S	74
<b>S15</b>	<b>Pag.</b>	S22H6500	73	S42M4250	73	<b>S63</b>	<b>Pag.</b>
S15H240	72	S22H6500RK	73	S42M475	73	S63H3306	70
S15H356	72	<b>S23</b>	<b>Pag.</b>	<b>S43</b>	<b>Pag.</b>	S63H3307	70
S15H472	72	S23H21115	73	S43H210	74	S63H3308	70
S15H6109	72	S23H31200	73	S43V38	109	S63H3310	70
		S23H41250	73	S43V480	109	S63H4132S	57

S63H4306	70	S64H4708	71	S68H2111	54	<b>T16</b>	<b>Pag.</b>
S63H4307	70	S64H4709	71	S68H2112	54	T16005N-R	44
S63H4308	70	S64H4710	71	S68H2113	54	<b>T19</b>	<b>Pag.</b>
S63H4310	70	S64H4712	71	S68H2114	54	T19135N	44
S63H4312	70	S64H4714	71	S68H2141S	53	T19200N	44
S63H4313	70	S64H4808	71	S68H4127S	53	<b>T21</b>	<b>Pag.</b>
S63H4405	70	S64H4810	71	S68H5234111S	54	T21025N	43
S63H4406	70	S64H4812	71	<b>T04</b>	<b>Pag.</b>	T21025N-R	44
S63H4407	70	S64H4814	71	T04M060-R	44	T21050N	43
S63H4408	70	<b>S66</b>	<b>Pag.</b>	T04M061-R	44	T21050N-R	44
S63H4409	70	S66H4108	65	T04M150-R	44	T211000N	43
S63H4410	70	S66H4110	65	T04M250-R	44	T211000N-R	44
S63H4412	70	S66H4112	65	<b>T07</b>	<b>Pag.</b>	T21101N	43
S63H4413	70	S66H4115	65	T07030N-R	44	T21101N-R	44
S63H4414	70	S66H4117	65	T07110N-R	44	T21200N	43
S63H4507S	70	S66H4126	65	T07350N-R	44	T21200N-R	44
S63H4605	71	S66H4128	65	T07700N-R	44	T21340N	43
S63H4606	71	S66H4136	65	<b>T09</b>	<b>Pag.</b>	T21340N-R	44
S63H4607	71	S66HD4110	65	T094602	45	T21341N	43
S63H4608	71	S66HD4111	65	T094602-RK	45	T21341N-R	44
S63H4609	71	S66HD4112	65	T096801	46	T21550N	43
S63H4610	71	S66HD4113	65	T096801-RK	46	T21550N-R	44
S63H4612	71	S66HD4114	65	<b>T10</b>	<b>Pag.</b>	<b>T25</b>	<b>Pag.</b>
S63H4613	71	S66HD4115	65	T10148	46	T25100N	43
S63H4614	71	S66HD4116	65	T102001S	44	T25100N-R	44
S63H4708	71	S66HD4117	65	T102001S-R	44	T25200N	43
S63H4709	71	S66HD4118	65	T10313	43	T25200N-R	44
S63H4710	71	S66HD4119	65	T10314	43	T25340N	43
S63H4712	71	S66HD4120	65	T10315	43	T25340N-R	44
S63H4713	71	S66HD4121	65	T10316	43	<b>T27</b>	<b>Pag.</b>
S63H4714	71	S66HD4122	65	T10317	43	T27-D2R	44
S63H4808	71	S66HD4123	65	T10318	43	T27-D3R	44
S63H4809	71	S66HD4124	65	T10319	43	T27-D4R1	44
S63H4810	71	S66HD4127	65	T10321	43	T27-D4R2	44
S63H4812	71	S66HD4130	65	T10322	43	T27-D6R	44
S63H4813	71	S66HD4132	65	T10324	43	T27-D8R	44
S63H4814	71	<b>S68</b>	<b>Pag.</b>	T10H1210S	43	T27010N	43
<b>S64</b>	<b>Pag.</b>	S68H2103	54	<b>T12</b>	<b>Pag.</b>	T27020N	43
S64H4107	71	S68H2104	54	T12112S	43	T27021N	43
S64H4109	71	S68H2104S	54	<b>T14</b>	<b>Pag.</b>	T27060N	43
S64H4113	71	S68H2105	54	T14100N	43	T271001N	43
S64H4126S	57	S68H21055	54	T14200N	44	T27101N	43
S64H4205	71	S68H2106	54	<b>T15</b>	<b>Pag.</b>	T27200N	43
S64H4206	71	S68H21065	54	T154100N	44	T27340N	43
S64H4209	71	S68H2107	54	T154100N-R	44	T27800N	43
S64H4210	71	S68H2108	54	T154200N	44	<b>T29</b>	<b>Pag.</b>
S64H4705	71	S68H2109	54	T154200N-R	44	T29014	43
S64H4706	71	S68H2110	54				

<b>T30</b>	<b>Pag.</b>	W23V112	110	W25V109	110	W26160	50
T30200NS	43	W23V113	110	W25V110	110	W26165	50
<b>V10</b>	<b>Pag.</b>	W23V114	110	W25V113	110	W2623431SV	36
V1001	87	<b>W24</b>	<b>Pag.</b>	W25V114	110	W26411PRS	50
V1002	87	W240809	49	<b>W26</b>	<b>Pag.</b>	W26414S	50
V1003	87	W241011	49	W26106	50	<b>W27</b>	<b>Pag.</b>
V1005	87	W241012	49	W26107	50	W27AK8	53
<b>V11</b>	<b>Pag.</b>	W24106S	49	W26108	50	W27AR10	52
V11011SC	39	W241314	49	W26109	50	W27AR8	52
V1103	87	W241417	49	W26110	50	W27AS10	52
<b>V13</b>	<b>Pag.</b>	W241617	49	W26111	50	W27AS15	52
V1310A	87	W241719	49	W26112	50	W27AS18	52
V1310A-11	87	W241819	49	W26112S	50	W27AS8	52
V1310B-11	87	W241922	49	W26112SP	33	W27AT02SC	39
V1310C	87	W242528	49	W26113	50	W27AT10	52
V1310E	87	W243032	49	W26114	50	W27AT12	52
V1310E-11	87	W24A107S	46	W26114S	50	W27AT15	52
V1310F	87	W24A109SP	33	W26115	50	W27AT8	52
V1310SP	33	W24N0810	49	W26116	50	<b>W28</b>	<b>Pag.</b>
<b>V14</b>	<b>Pag.</b>	W24N1113	49	W26116KV	38	W2808	53
V1401	87	W24N1214	49	W26116SP	33	W2810	53
V1403	87	W24N1719	49	W26117	50	W2810RJ-HL	53
<b>V15</b>	<b>Pag.</b>	<b>W25</b>	<b>Pag.</b>	W26118	50	W2812	53
V1501	87	W250607	49	W26119	50	W2812RJ-HL	53
V1505	87	W250809	49	W26120	50	W2814	53
<b>V21</b>	<b>Pag.</b>	W251011	49	W26121	50	W2814RJ-HL	53
V2101	87	W25108S	49	W26122	50	W2818	53
V2102	87	W25110KV	38	W26123	50	W2818RJ-HL	53
<b>W23</b>	<b>Pag.</b>	W25110SP	33	W26124	50	W2824	53
W230607	49	W25117SC	39	W26125	50	W2824RJ-HL	53
W230809	49	W251213	49	W26126	50	W2836	53
W231011	49	W251415	49	W26126S	50	W2836RJ-HL	53
W23108S	49	W251417	49	W26127	50	W28HD10	53
W23108SP	33	W251617	49	W26128	50	W28HD12	53
W231213	49	W251819	49	W26129	50	W28HD14	53
W231415	49	W252022	49	W26130	50	W28HD8	53
W231617	49	W252123	49	W26132	50	<b>W29</b>	<b>Pag.</b>
W231819	49	W252426	49	W26134	50	W290608	51
W232022	49	W252427	49	W26134SV	36	W290711	51
W232123	49	W252528	49	W26136	50	W291012	51
W232426	49	W252730	49	W26138	50	W291418	51
W232427	49	W252732	49	W26141	50	W291622	51
W232528	49	W253032	49	W26142	50	W292024	51
W233032	49	W253236	49	W26144	50	<b>W39</b>	<b>Pag.</b>
W23559SV	36	W253641	49	W26146	50	W391011	50
W23V108	110	W254146	49	W26148	50	W391213	50
W23V110	110	W254650	49	W26150	50	W391415	50
W23V111	110	W25V108	110	W26155	50	W391617	50
						W391819	50

<b>W43</b>	<b>Pag.</b>	<b>W62</b>	<b>Pag.</b>	<b>W68</b>	<b>Pag.</b>	<b>W84</b>	<b>Pag.</b>
W43A0607	51	W6210607	48	W680809	48	W84106	54
W43A0809	51	W6210809	48	W680810	48	W84107	54
W43A1011	51	W62108S	49	W681011	48	W84108	54
W43A106S	51	W6211011	48	W68106S	48	W84108S	54
W43A1213	51	W6211213	48	W681213	48	W84109	54
W43A1415	51	W6211415	48	W681415	48	W84110	54
W43A1617	51	W6211617	48	W681618	48	W84111	54
W43A1819	51	W6211819	48	W681719	48	W84112	54
<b>W45</b>	<b>Pag.</b>	W6212022	48	<b>W69</b>	<b>Pag.</b>	W84113	54
W45108	46	W6212427	48	W69116S	51	W84114	54
W45109	46	W6212528	48	<b>W70</b>	<b>Pag.</b>	W84114S	54
W45110	46	W6213032	48	W70A118S	33	W84115	54
W45111	46	<b>W65</b>	<b>Pag.</b>	<b>W72</b>	<b>Pag.</b>	W84116	54
W45112	46	W6510810	51	W72122	33	W84117	54
W45112SP	33	W6511012	51	W72124	33	W84118	54
W45113	46	W6511315	51	W72127	33	W84119	54
W45114	46	W6511417	51	W72130	33	<b>W86</b>	<b>Pag.</b>
W45115	46	W6511922	51	W72132	33	W86112S	54
W45116	46	W65A105S	51	W72134	33	<b>W91</b>	<b>Pag.</b>
W45117	46	<b>W66</b>	<b>Pag.</b>	W72136	33	W91107S	48
W45117S	46	W66107S	47	W72141	33	<b>W93</b>	<b>Pag.</b>
W45118	46	W66108	47	W72146	33	W93108S	48
W45119	46	W66109	47	W72150	33	W93110	48
W45121	46	W66110	47	W72170	33	W93111	48
W45124	46	W66111	47	<b>W73</b>	<b>Pag.</b>	W93112	48
W45316S	47	W66112	47	W73102S	48	W93113	48
W45316S-AD	47	W66113	47	<b>W77</b>	<b>Pag.</b>	W93114	48
<b>W47</b>	<b>Pag.</b>	W66114	47	W77A124	52	W93115	48
W47108SP	33	W66115	47	W77A127	52	W93117	48
<b>W51</b>	<b>Pag.</b>	W66116	47	W77A130	52	W93119	48
W51110S	47	W66116S	47	W77A132	52	<b>WF</b>	<b>Pag.</b>
<b>W52</b>	<b>Pag.</b>	W66117	47	W77A136	52	WFS46	52
W52105S	47	W66118	47	W77A138	52	<b>WV</b>	<b>Pag.</b>
<b>W60</b>	<b>Pag.</b>	W66119	47	W77A141	52	WV27AS10	110
W60115SP	33	<b>W67</b>	<b>Pag.</b>	W77A146	52		
<b>W61</b>	<b>Pag.</b>	W67104S	47	W77A150	52		
W611011	48	W67119	52	W77A155	52		
W61106S	48	W67121	52	W77A160	52		
W611214	48	W67124	52	W77A165	52		
W611315	48	W67130	52	W77H01	52		
W611618	48			W77H02	52		
W611719	48			W77H03	52		
W612224	48			W77H04	52		

<b>ARTÍCULO</b>	<b>PÁG.</b>	<b>ARTÍCULO</b>	<b>PÁG.</b>
Accesorios de aire comprimido	163 - 164	Enrollador manguera aire	163
Adaptador para llave de vaso	72, 76, 78	Escuadra en metal	105
Alicate centrador de embrague/muelles de frenos	128	Esmeriladora recta neumática	153 - 154
Alicate corta cables	86	Extensión para llaves de vaso	72 - 74
Alicate, extractor para válvulas y segmentos	120	Extensor en espiral hembra	164
Alicates de bloqueo	88 - 89	Extractores y sacas	113 - 115
Alicates de pelar y engatillar	87	Faca neumática	160
Alicates de uso general	83 - 86	Filtros lubricante regulador	163, 164
Alicates para abrazaderas	123, 131	Flexómetro	105
Amoladoras neumáticas	153 - 154	Fresadora de puntos de soldadura	153
Armarios de oficinas	16	Gambiarra Leds	106
Aspirador de aceite	25	Gato chapista	24
Atornilladora neumática	152, 153	Gato hidráulico	23
Bancos de apoyo	23	Gato hidráulico de anchura	23
Bandeja de recoger aceite	25, 112	Gato hidráulico de foso	22
Bandejas magnéticas	117	Gato hidráulico para transmisiones	22
Barras magnéticas	71, 106	Grapas de plástico	145
Barras para puertas	24	Grua hidráulica	23
Boligrafo magnético	116	Herramienta especial mecánica auto	112 - 136
Bomba de engrase	162	Herramienta especial para motos	137 - 139
Bomba hidroneumática	22	Herramienta especial por marca	132 - 137
Bombas vacío y presión	123	Herramienta para válvulas	127
Caballetes	24, 112	Herramientas aisladas 1 000V	107 - 110
Cable T corredizo	73	Herramientas para frenos neumático	127
Cabos de batería	131	Herramientas para pesados	144 - 145
Cajas de herramientas	18, 19	Hidrómetro	130
Calibre lectura vigesimal	105	Jeringas	116
Camilla para mecánico	23	Juegos de puntas	56 - 57
Cardáns	xx, 75 - 79	Juegos llaves Supertech	53 - 54
Carro con 3 estantes	18	Juegos llaves de vaso con trinquete	46 - 48
Carros vacíos	17, 18	Kit para eliminación de radios	131
Carros y composición herramientas	6 - 18	Kits comando motores	118 - 119, 132 - 136
Chaves de velas incandescência	111, 112	Levanta ruedas	25
Compresor de grapas	115	Lijadoras	154 - 156, 158 - 159
Comprobación de inyectores	121	Lima de chapista	142
Comprobador de presión	121	Limas y limatões	104
Compás	105	Llave para golpes (boca/estrella)	52
Corta tubos	130	Llave para polea alternador	120
Cuter	105	Llave para tapón aceite	125
Cuña de chapista	141	Llave pie de gallo	43, 75
Destornillador de golpe	142 - 143	Llaves combinadas, fijas y mixtas	46 - 51
Destornilladores plano, philips, torx, pozi	90 - 94	Llaves de estrella curvada	51

<b>ARTÍCULO</b>	<b>PÁG.</b>	<b>ARTÍCULO</b>	<b>PÁG.</b>
Llaves de estrella curvada	51	Pistolas pulverizadoras	116
Llaves de pipa	51	Pistoletes de aire e agua	163
Llaves de ruedas	117	Prueba de presión para radiadores	112
Llaves de tubos	53	Pulidor neumático de válvulas	159
Llaves de vaso	60 - 65	Pulidora de cilindros	129
Llaves de vaso bujias	72, 125	Pulidoras	155
Llaves de vaso flexible	51	Punta para válvulas de los neumáticos	117
Llaves de vaso punta allen, plano, phillips	68, 70	Puntas e porta puntas	94 - 97
Llaves de vaso y punta torx	65 - 67	Punzones	103, 104
Llaves para velas de incandescencia	121, 122	Quita tapizados de plástico	140, 141
Llaves dinamométricas	43, 44	Regla en metal	105
Llaves en L	97 - 101	Remachadora	87
Llaves filtros	123 - 126	Remachadora neumática	162
Llaves impacto y accesorios	75 - 82	Reparación de las roscas	127 - 128
Llaves inglesa	52, 53	Roedora neumática	161
Llaves para inyectores	119	Saca abolladuras	142
Llaves para retirar hembras dañadas	95, 130	Saca casquillos	117
Llaves para sondas de oxígeno	126	Saca trozos	103 - 104
Llaves pico de halcón	53	Sacas y extractores	113 - 115
Llaves rótula axial de dirección	128	Sierras	104
Malaleta electricista	130	Sierras neumáticas	159 - 160
Malaletas de herramientas	57 - 59	Soporte de motores	24
Mango articulado	73	TAS de chapista	141
Mango para llaves de vaso	72 - 74	Tableros de herramienta	28 - 42
Martillo chapista	142	Taladradora neumática	152
Martillos de uso general	102	Tenazas	86
Martillos neumáticos	161	Termómetro infrarrojos	25
Medidor angular de torque	117	Test de atuadores	130
Medidor digital de profundidad	129	Test fluido de frenos	130
Mesa de trabajo	26	Test líquido refrigerante/ baterías	115
Micrómetro	106	Test vacío y bomba combustible	130
Multímetro	25	Tijera articulada	86
Máquina llave impacto neumática	148 - 151	Tijeras	86
Máquina llave impacto sin hilos	26	Tijeras neumáticas	160, 161
Navajas	104	Tira de soporte para llaves de vaso	71
Palanca para desmontaje	129	Tornillo de banco	20
Palancas de chapista	141	Travesano para soporte de motores	23, 24
Piezas rascar/quitar	122 - 123	Trinquetes manuales	44 - 46
Pinza amperimétrica	25	Trinquetes neumáticos	151 - 152
Pinzas de chapista	143	Ventosas	140 - 141
Pistolas de pintura	157		



*No utilizar con herramientas neumáticas llaves de vaso u otras herramientas de uso manual. Utilice llaves de vaso de impacto y sus accesorios.*



*No utilizar martillos o tubos para aumentar el torque en llaves de ajuste, llaves dinamométricas y trinquetes.*



*No utilice destornilladores como palanca, cortafríos o punzones. Existen herramientas especiales para esos casos.*

## Herramienta Manual

- Deberá tener mucho cuidado en la utilización de cualquier herramienta, manteniéndolas alejadas de los niños.
- Se recomienda la utilización de gafas y guantes de protección y de protecciones en los oídos (si aplicable).
- Deberá desconectar siempre la corriente antes de realizar cualquier tipo de manejo en las superficies conductivas, para evitar descargas eléctricas. En estos casos, utilice siempre herramientas aislantes.
- Deberá elegir el género y tamaño correcto de la herramienta manual para el trabajo a realizar. Las unidades de medida sirven para seleccionar la herramienta con el tamaño correcto.
- Deberá mantener las herramientas limpias.
- Deberá leer las instrucciones antes de utilizar las herramientas.
- No deberá cambiar ninguna herramienta.
- Sólo abra un cajón cada vez, así evitará la posibilidad de volcar el carro de herramientas.
- Nunca deberá usar un cajón como escalera (peligro de volcar el carro de herramientas).
- No deberá tirar del carro de herramientas de espaldas.

## Herramienta Neumática

Las herramientas neumáticas JONNESWAY permite a sus operadores disfrutar de un uso seguro, una gran fiabilidad y la reducción casi total de las vibraciones en sus tareas diarias.

Las medidas de seguridad que detallamos incluyen las posibilidades o condiciones que pueden ocurrir durante su uso. Antes de utilizar herramientas neumáticas, deberá leer atentamente estas advertencias para evitar riesgos innecesarios.

### • Elementos de protección personal

Para evitar lesiones, se recomienda la utilización de máscaras, gafas, auriculares y guantes de protección siempre que se manejan herramientas neumáticas.

### • Prevención de daños causados por vibraciones o movimientos repetitivos

La exposición prolongada a vibraciones o movimientos repetitivos de trabajo puede ser perjudicial. Cuando se siente hormigueo, entumecimiento, malestar o dolor, se debe dejar de usar la herramienta. Los operadores deberán seguir siempre las siguientes instrucciones:

- Utilice siempre los mangos y asas para evitar accidentes y garantizar el buen uso de los equipos.
- Mantenga las muñecas lo más recto posible.
- Evite movimientos repetitivos de las manos y muñecas.
- Mantenga las manos y el cuerpo secos y calientes.
- Evite la exposición continua y prolongada a vibraciones muy prolongadas.





- **Evitar los peligros del aire comprimido**
- El aire comprimido puede causar daños o lesiones. Tenga en cuenta las siguientes medidas de seguridad para garantizar un entorno de trabajo más seguro.
- Nunca apunte el tubo de aire hacia usted o hacia otros. Todas las personas en el taller deberán permanecer lejos del escape de aire.
- Antes de utilizar la herramienta neumática, deberá controlar el estado de las tuberías y accesorios del sistema neumático.
- Deberá apagar y desconectar la herramienta cuando no esté en uso, cuando cambie accesorios, o cuando se hacen reparaciones.
- Deberá mantener siempre la presión del aire en el rango apropiado. El uso de herramientas fuera de estos valores disminuirá su rendimiento y vida útil de la herramienta.
- No conecte aparatos de aire a tomas de corriente.
- Cuando se utilicen conectores universales, deberán ser siempre instalados toques horquilla de bloqueo para evitar que las tuberías se desconecten accidentalmente.

- **Evitar riesgos adicionales**
- Resbalones, tropezones y caídas son la principal causa de lesiones y muertes en accidentes de trabajo! Deberá tener cuidado con los tubos y cables en la área de trabajo.
- Los operadores y técnicos de mantenimiento deben ser físicamente capaces de realizar sus tareas y soportar el volumen, peso y potencia de la herramienta.
- Cuando opere con una esmeriladora o tronzadora deberá utilizar pantalla de protección para reducir el riesgo de cortes y abrasiones debido a los materiales que puedan saltar.

### Sistema Neumático de alimentación

- 1 Filtro
- 2 Drenaje
- 3 Secador de Aire
- 4 Depósito de Aire
- 5 Compresor de Aire
- 6 Filtro Regulador - Lubricante

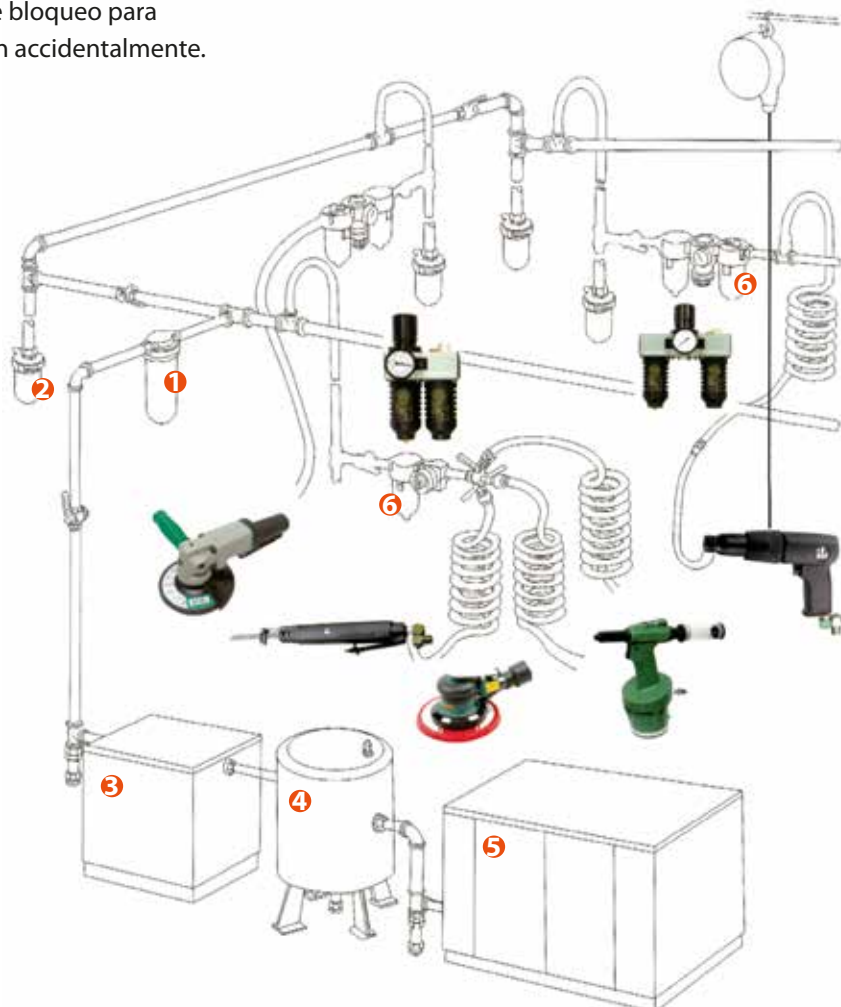

## Recomendaciones de mantenimiento

Al conectar la herramienta neumática a la red de aire comprimido, deberá asegurarse de que la presión en esta es de 6.2kg/cm<sup>2</sup> (90 psi). Si la presión en la red de aire comprimido es demasiado alta puede dañar la herramienta o si es demasiado bajo influirán el funcionamiento de la misma y reducirá su vida útil.

- Se recomienda la instalación de filtros reguladores lubricadores adecuados a la herramienta en uso. La entrada de aire debe tener aceite lubricante apropiado, para lubricar el motor interno de la herramienta. (Coloque un papel blanco en la salida de aire para ver si hay contaminación con aceite, lo que indica que hay suficiente petróleo).
- La toma de aire no debe tener agua. Si esto ocurre, se recomienda comprobar o instalar un secador de aire.
- No se deberá desmontar la herramienta, ya que puede dañar y afectar la seguridad del usuario.
- Incluso si la herramienta tiene daños menores o no realice las funciones especificadas por el fabricante, no se debe utilizar hasta que sea inspeccionada.
- Para mantener el funcionamiento de la herramienta, deberá realizar controles periódicos (cada semana), mantenimiento preventivo y lubricaciones (engrasar las piezas giratorias y añadir aceite lubricante al motor).
- Al utilizar herramientas neumáticas deberá cumplir con las instrucciones de seguridad y de uso.
- Es esencial elegir las herramientas adecuadas para el trabajo por hacer, ya que si la herramienta tiene una potencia muy alta, puede dañar la pieza que está trabajando o si tienen poco poder, puede dañar la propia herramienta.

## Términos de la garantía

La herramienta manual y neumática Jonnesway es fabricada con los más altos estándares de calidad, pero para todos los efectos, son herramientas que se desgastan con el uso. Por tanto, es normal ese desgaste, incluso cuando la herramienta se utiliza en condiciones normales. De este modo, la garantía de la herramienta depende de todas las condiciones siguientes:

- Para herramientas de mano se les ofrece una garantía de "vida útil", garantía que cubre defectos en materiales y mano de obra. Se entiende por "vida útil" el período de vida esperable para la herramienta en cuestión, cuando se utiliza en condiciones normales de uso y para los fines para que fue diseñada.
- La gama de herramientas neumáticas y instrumentos de medición se excluyen del punto 1. Los productos están diseñados y fabricados para el uso profesional. El período de garantía es de un año (12 meses) para el uso profesional y dos años (24 meses) para uso privado. El período de garantía comienza en la fecha de adquisición. Esta fecha debe ser verificada en la factura de compra.
- Cualquier producto que se ha utilizado o mantenido incorrectamente, que ha sufrido el desgaste debido al uso incorrecto o ha sido objeto de modificaciones no autorizadas, no está cubierto por la garantía.
- La falta de mantenimiento preventivo o la utilización de presión de aire comprimido y lubricación inadecuada es motivo de pérdida de la garantía.



# JONNESWAY.

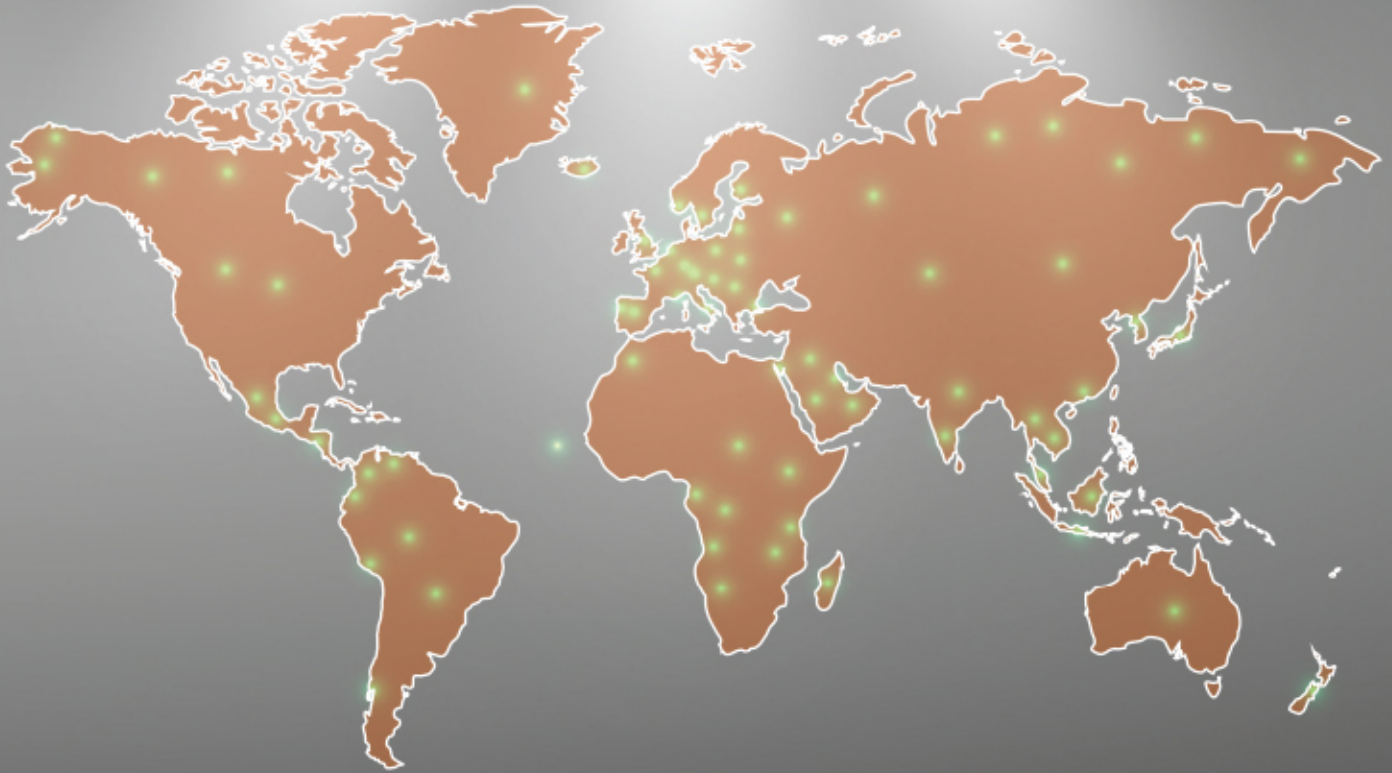

Certificate TWS020271

SGS

The management system of  
**JONNESWAY ENTERPRISE  
 CO., LTD.**  
 #F-8, No. 87, Sec. 2, Keelung Rd,  
 Taipei City, Taiwan, R.O.C.

has been assessed and certified according to the requirements of  
**ISO 9001:2008**

for manufacturing activities

Marketing under **JONNESWAY** Brand of professional hand tools,  
 professional pneumatic tools, professional auto repair tools & garage  
 equipment and working machines.

Public certification according to scope of this certificate and the quantity of  
 all ISO 9001:2008 certificates has been issued by issuing the registration.

This certificate is valid from 14 February 2010 until 13 September 2011 and  
 remains valid subject to satisfactory surveillance audits.

Pre-certification audit date before 09 February 2010  
 Issue 4. Certificate issue 14 February 2010

Reference

SGS and its related companies are authorized to issue this certificate  
 in accordance with the requirements of the ISO 9001:2008  
 4-0000 200801 1-04 2010 201001 40000001

UKAS  
 MANAGEMENT SYSTEMS  
 CERTIFICATION  
 0001

Page 1/1

**VDE Prüf- und Zertifizierungsinstitut**

**ZEICHENGENEHMIGUNG  
 MARKS APPROVAL**

Jonnesway Enterprise  
 Co., Ltd.  
 #F-8, No. 87, Sec. 2, Keelung Rd,  
 110 Taipei  
 TAIWAN

is authorized to use for their product  
**Zange, Isoliert  
 Pliers, Insulated**

Die hier abgebildeten markenrechtlichen geschützten Zeichen  
 für die ab Blatt 2 aufgeführter Typen zu benutzen /  
 The legally protected signs as shown below for the types referred to on page 2 of.

Beschriftung und Zertifizierung nach /  
 Marked and certified according to

EN EN 60959 VDE 0100 Teil 201:2005(1) DE 60959(1)

Das Produkt entspricht eine Anforderungen des Deutschen Ordner und Produktzertifizierungs  
 Gremiums hinsichtlich der Eindeutigkeit von Symbolen und Geometrien.  
 The product covers the requirements of the German A-Z "German and Product Certification" report  
 010502" regarding the measures of safety and health.

Deutsche num / valid with 307102-26. Antragsnummer: 4142193/2008/011 / 118844

VDE Prüf- und Zertifizierungsinstitut GmbH  
 Testing and Certification Institute  
 Zertifizierung / Certification  
 Postfach 2445, 10544 Berlin, Germany  
 www.vde.com  
 030 2663-2000  
 20.09.2008

Page 1/1



# JONNESWAY®

Herramientas Profesionales Manuales y Neumáticas



Importador para España, Francia, Portugal, Angola y Cabo Verde

Minorista



**LUSILECTRA**  
GRUPO SALVADOR CAETANO

Rua Engº Ferreira Dias, 953/993 • 4100-247 Porto • Portugal  
Tel. +351 226 198 750 • Fax. +351 226 158 669  
Email. [equip.oficina@lusilectra.pt](mailto:equip.oficina@lusilectra.pt) • [www.lusilectra.pt](http://www.lusilectra.pt)

